

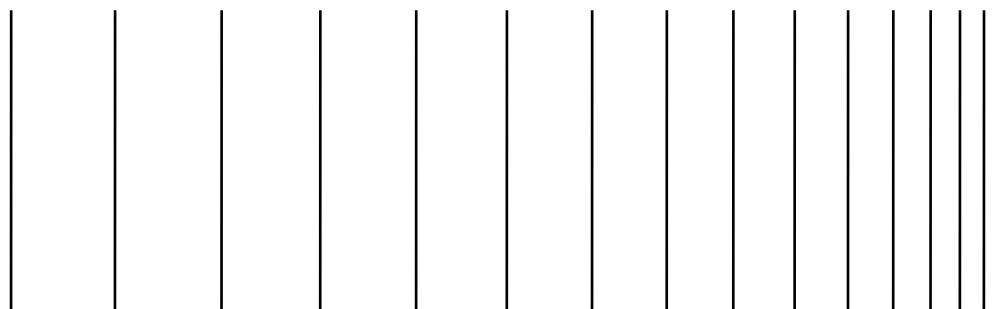

HITACHI INDUSTRIAL COMPUTER

HF-W7500 Model 50

INSTRUCTION MANUAL

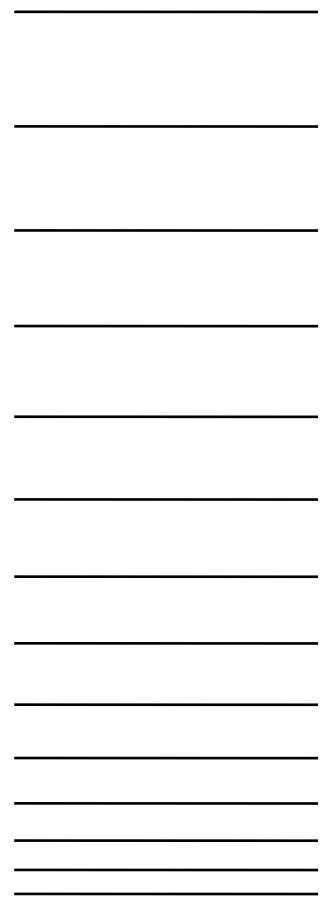

**USER'S
MANUAL**

HITACHI INDUSTRIAL COMPUTER

HF-W7500 Model 50

INSTRUCTION MANUAL

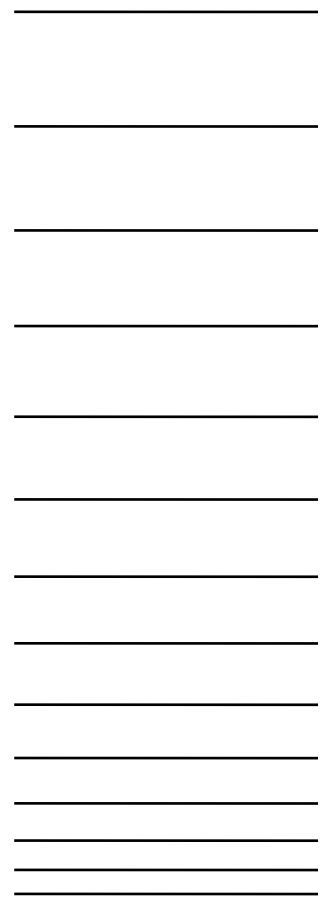

Read and keep this manual.
<ul style="list-style-type: none">• Read safety instructions carefully and understand them before starting your operation.• Keep this manual at hand for reference.

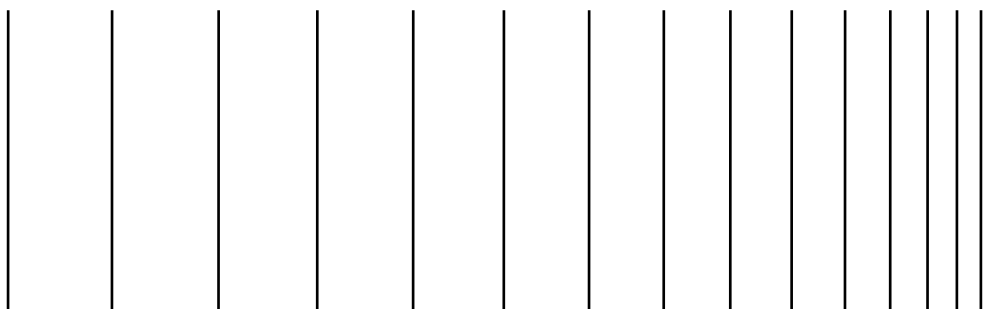

**USER'S
MANUAL**

First Edition, July 2018, WIN-62-0071 (out of print)
Second Edition August 2019, WIN-62-0071-01

All Rights Reserved, Copyright © 2019, Hitachi Industrial Products, Ltd.

The contents of this publication may be revised without prior notice.

No part of this publication may be reproduced in any form or by any means without permission in writing from the publisher.

Printed in Japan.

TP<IC> (FL-MW2007)

PREFACE

This manual is intended for operators of the HITACHI INDUSTRIAL COMPUTER HF-W7500 MODEL 50 (hereafter called as this equipment) contains information about the operation and maintenance of various devices necessary for their routine work. And also this manual describes the setup procedure of the OS installed in this equipment, namely the following pre-installed OS.

- Windows® 7 Professional for Embedded Systems SP1
- Windows® 10 IoT Enterprise 2016 LTSC
- Windows Server® 2016 Standard

In the following pages, those marked as Windows® 7, Windows® 10, Windows Server® 2016 indicate the above OS.

SEPARATE VOLUME CONSTITUTION

The manual of the HITACHI INDUSTRIAL COMPUTER HF-W7500 MODEL 50 consists of the following:

- SAFETY INSTRUMENTS
- INSTRUCTION MANUAL (This manual)
- RAS FEATURES MANUAL

MANUAL CONSTITUTION

This manual consists of the following:

PREFACE

IMPORTANT NOTIFICATIONS

SAFETY INSTRUCTIONS

PRECAUTIONS

CHAPTER 1 GETTING STARTED

CHAPTER 2 OPERATION

CHAPTER 3 SET UP

CHAPTER 4 PRECAUTIONS WHILE THE OS IS RUNNING

CHAPTER 5 SPECIFICATIONS

CHAPTER 6 CHECKUP AND MAINTENANCE

CHAPTER 7 RESTORING THE FACTORY-SHIPED CONDITION USING
A RECOVERY DVD

CHAPTER 8 MAINTENANCE OPERATIONS

CHAPTER 9 TROUBLESHOOTING

CHAPTER 10 RAID1

APPENDIX HANDLING REPLACEABLE COMPONENTS

[Trademarks]

- Microsoft®, Windows®, Internet Explorer® and Hyper-V® are registered trademarks of U.S. Microsoft Corporation in the United States and other countries.
- Intel® and Intel® Xeon® are trademarks of Intel Corporation in the United States and other countries.
- DisplayPort is a trademark or a registered trademark of Video Electronics Standards Association in the United States and other countries.
- Magic Packet™ is a trademark or a registered trademark of Advanced Micro Devices, Inc.
- All other product names (software and hardware) not from Hitachi described in this manual are the registered trademarks, the trademarks, or the products of their respective owners.
- Zlib is used as a compression and decompression engine built in a part of the software of this product. Its copyright notice is as follows:
Zlib ver 1.2.3 Copyright © 1995-2005 Jean-loup Gailly and Mark Adler

IMPORTANT NOTIFICATIONS

- The contents of this manual cannot be copy without permission.
- The contents of this manual are subject to change without notice.

NOTICE

Depending on the type of failure, important files may be lost when you use this equipment. Files can be lost by power failure and human mistakes during operation in addition to the failure of the equipment. If such a situation occurs, the files cannot be recovered. In order to prevent data loss, make it a routine to save your files and establish a systematic schedule for backing up files.

- Harmonic Current Standards

This equipment is compliant with the JIS C 61000-3-2 Harmonic Current Standard.

- VCCI Notice

This is a Class A product based on the standard of the Voluntary Control Council for Interference by Information Technology Equipment (VCCI). If this equipment is used in a domestic environment, radio noise disturbance may arise. When such trouble occurs, the user may be required to take corrective actions.

[Note for storage capacity calculations]

- Memory capacities and requirements, file sizes and storage requirements, etc. must be calculated according to the formula 2^n . The following examples show the results of such calculations by 2^n (to the right of the equals signs).

1 KB (kilobyte) = 1,024 bytes

1 MB (megabyte) = 1,048,576 bytes

1 GB (gigabyte) = 1,073,741,824 bytes

1 TB (terabyte) = 1,099,511,627,776 bytes

- As for disk capacities, they must be calculated using the formula 10^n . Listed below are the results of calculating the above example capacities using 10^n in place of 2^n .

1 KB (kilobyte) = 1,000 bytes

1 MB (megabyte) = $1,000^2$ bytes

1 GB (gigabyte) = $1,000^3$ bytes

1 TB (terabyte) = $1,000^4$ bytes

- This equipment has been tested and found to comply with the limits for a Class A digital device, pursuant to part 15 of the FCC Rules. These limits are designed to provide reasonable protection against harmful interference when the equipment is operated in a commercial environment.

This equipment generates, uses and can radiate radio frequency energy and, if not installed and used in accordance with the instruction manual, may cause harmful interference to radio communications. Operation of this equipment in a residential area is likely to cause harmful interference in which case the user will be required to correct the interference at his own expense.

- 이 기기는 업무용(A급) 전자파적합기기로서 판매자 또는 사용자는 이 점을 주의하시기 바라 며, 가정외의 지역에서 사용하는 것을 목적으로 합니다.

This equipment conforms to the electromagnetic wave for Industrial use (Class A).Vender or user should take notice and use the purpose except for household use.

[Terms used in this manual]

Terms used in this manual are defined as follows.

- Install: An operation of installing software programs in the computer's HDD
- Setup: An operation of setting an environment so that the software can use in the computer
- Virtual machine: A virtual hardware environment provided by Virtual PC or Hyper-V®
- Host OS: A base operating system that operates the virtual machine
- Guest OS: An operating system that runs on the virtual machine

[Rereading terms]

This manual describes the Windows® operating procedure. Names of operations “sign in” and “sign out” are replaced with “log on” and “log off” respectively depending on Windows® types. Reread them as required.



SAFETY INSTRUCTIONS

Carefully read and fully understand the safety precautions below before operating the equipment.

- Operate the equipment by following the instructions and procedures described in this manual.
- Pay attention especially to safety precautions displayed on the equipment or in this manual. Make sure you follow them. Otherwise, personal injury and property damage including damage to the equipment may result.
- A safety precaution is indicated by a heading as shown below. A heading is either a safety alert symbol; a word such as “DANGER”, “WARNING”, “CAUTION”, or “NOTICE”; or a combination of both.



This is a safety alert symbol. This symbol is used to signify potential hazards that may result in personal injury or death. Make sure you follow the safety message that follows this symbol in order to avoid possible injury or death.



DANGER: This symbol is used to indicate imminent hazards that will highly likely result in serious personal injury or death.



WARNING: This symbol is used to indicate potential hazards that may result in serious personal injury or death.



CAUTION: This symbol is used to indicate potential hazards that may result in minor or moderate personal injury.

NOTICE: This symbol is used to indicate hazards that may result in equipment or property damage but not personal injury.

The heading “NOTE” is used to indicate a cautionary note about handling and operation of the equipment.

- Do not attempt to perform any operation that is not described in this manual. If there is any problem with the equipment, call your maintenance personnel.
- Read this manual carefully and fully understand the directions and precautions written in this manual before operating the equipment.
- Keep this manual nearby so that you can reference the manual anytime you need it.
- Every effort has been made to specify the best precautions on the equipment and in the manual. Nevertheless, unexpected incidents may occur. When you use the equipment, you are asked not only to follow the instructions but also to use your own judgment on safety.



SAFETY INSTRUCTIONS (Continued)

1. COMMON SAFETY PRECAUTIONS

Carefully read and fully understand the following safety precautions.

1.1 WARNING

- This equipment is not designed and manufactured to be used for a life-critical system that requires extreme safety. If there is a possibility that the equipment may be used for this purpose, contact relevant sales representatives.
- In case of smoke, a burning smell, or the like, unplug the power cord from the outlet, disconnect the power cord from the outlet, and contact your supplier or maintenance personnel. Using the faulty equipment without repair may result in a fire or an electric shock.
- This equipment has built-in hard disk drives. Do not hit the equipment or give a shock or vibration to the equipment because that may cause the equipment to fail. Should you drop the equipment or damage its chassis, disconnect the power cord from the outlet and contact your maintenance personnel. Using the faulty equipment without repair may result in a fire or an electric shock. Do not give a shock to the equipment when unpacking or carrying the equipment.
- Do not modify this equipment because that may result in a fire or an electric shock. The Manufacturer's responsibility is exempted from any result arising out of the user's modification of the Equipment.
- Do not operate this equipment without the dust filter because that may cause of a fire. In addition, make sure you use the Hitachi brand dust filter.
- Do not open the equipment cover if you are not a maintenance personnel. In addition, do not install or replace the hardware.



SAFETY INSTRUCTIONS (Continued)

1.2 CAUTION

- If the equipment drops or is tipped over, personal injury may result. Pay full attention when transporting the equipment.
- Make sure you do not catch or hit your fingers to cause personal injury when unpacking or carrying the equipment.
- Before you clean or replace the dust filter or the case fan of this equipment, make sure you shut down the OS, disconnect the plug of the power cord from the outlet, and wait for at least one minute. Otherwise, the injury of hands and fingers may result.
- Risk of explosion if battery is replaced by an incorrect type. Dispose of used batteries according to the instructions.



SAFETY INSTRUCTIONS (Continued)

1.3 NOTICE

- This equipment alone cannot guarantee the system safety. In order to ensure sufficient safety of your system even when this equipment should fail, malfunction, or have program bugs, you must add systemic protections such as building external protective/safety circuits to facilitate safety measures to prevent personal injury and serious accidents.
- When you work on installation or replacement of hardware, wear an antistatic wrist strap to prevent the buildup of static electricity.
- When you tighten or remove a screw, use a screwdriver that fits the size and type of the head of the screw to avoid stripping the head.
When you tighten a screw, drive a screw along the axis of a tapped hole without adding too much torque in order to avoid damaging the thread.
- This equipment is evaluated with the hardware specified in this manual. Accordingly, use only the specified hardware when upgrading options or replacing components. If any other hardware is used for such upgrade or replacement, correct operation of the equipment will not be guaranteed.
- Do not use the equipment in the environment full of dust or with corrosive gas because that may cause the equipment to fail.
- Do not give a shock to the equipment when unpacking or carrying the equipment. If you do, that may cause the equipment to fail.
- Make sure sufficient clearance is provided for air intake and exhaust in front of and behind the equipment. Otherwise, the temperature inside the equipment may rise and that may cause a failure or short life span of the equipment. In addition, you need to ensure sufficient clearance for maintenance work.



SAFETY INSTRUCTIONS (Continued)

- Use the basic software that we specify. Operation is not guaranteed if any other basic software is used.
- Performing emergency shutdown (that is, unplugging the power cord from the outlet or shutting off the circuit breaker without proper shutdown of the OS) may cause the OS or applications not to work properly or may cause the saved data to be corrupted. Never perform emergency shutdown unless you must stop the system immediately due to some kind of error.
- Keep in mind that if the power supply is cut, the system may not be able to recover automatically.
- If you insert or access a disk (CD or DVD), the system load may increase and running applications may be affected. Do not insert or access a disk during online operation (system operation).
- Once disk (CD or DVD) access is complete, eject the disk from the DVD drive. Leaving it in the DVD drive may result in failure.
- Leaving the disk tray open may result in failure. Make sure that the disk tray is closed when not in use.



SAFETY INSTRUCTIONS (Continued)

2. SAFETY WARNINGS IN THIS MANUAL

2.1 Safety Warning Indicated as “ WARNING”

- Warning about the power supply unit (hazardous voltage)
Do not remove, disassemble, or modify the power supply unit. If you do, serious personal injury or death may result due to an electric shock.
(Page 1-4)
- The power cord that comes with the equipment is rated at the input voltage of 125 VAC. When using this equipment at over 125 VAC, prepare the power cord fitting input voltage and inspect the safeness of this equipment enough.
- When you connect the plug of the power cord to an outlet, make sure you use an outlet with a ground terminal (ground pole) that is properly grounded. In addition, you must install and use an earth leakage circuit breaker. If you do not take these measures, that may result in a fire or an electric shock.
- Do not use a two-prong plug without a ground pole because that may result in an electric shock or failure of the equipment.
(Page 1-14)
- If any of the air intake and exhaust holes of the equipment is blocked, the temperature inside the equipment may rise and that may cause a fire or failure of the equipment. Make sure sufficient clearance is provided around the equipment when you install. (See “1.6.2 Installation”.)
(Page 2-1)
- In case of smoke, a burning smell, or the like, unplug the power cord from the outlet, and contact your dealer or maintenance personnel. Using faulty equipment without repair may result in a fire or an electric shock.
(Page 2-4) (Page 9-1)
- Make sure to install a dust filter to equipment. If you do not, dusts enter into the equipment and the short circuit fire may occur as a result.
(Page 6-1) (Page 6-24)



SAFETY INSTRUCTIONS (Continued)

- Do not open the equipment cover if you are not a maintenance personnel. In addition, do not install or replace the hardware.
- Before you start the work, make sure you shut down the OS, unplug the power cord from the outlet, and wait for at least one minute. Otherwise, an electric shock or failure of the equipment may result.

(Page 6-6)

- Before you install or remove an extension board, make sure you shut down the OS, unplug the power cord from the outlet, and wait for at least one minute. If you install or remove an extension board without shutting down the power, an electric shock or a fire may result.

(Page 6-8)

- Always attach a slot cover to each unused slot and attach a connector cover to each unused connector. Otherwise, failure of the equipment or a fire may result.

(Page 6-10)

- Before you install or remove main memory, make sure you shut down the OS, unplug the power cord from the outlet, and wait for at least one minute. If you install or remove main memory without shutting down the power, an electric shock or a fire may result.

(Page 6-12)



SAFETY INSTRUCTIONS (Continued)

2.2 Safety Warning Indicated as “ CAUTION”

- Cautions about the fans (rotating objects)
Only maintenance personnel are allowed to remove a fan. If you remove a fan yourself, your hand or objects may be caught by the rotating part of the operating fan and personal injury may result.
(Page 1-4)
- If you keep at high temperature this equipment, do not touch bare hands.
Otherwise you may result burns.
(Page 1-13)
- When you install the equipment vertically, be sure to secure it with a vertical installation bracket. If you do not secure it with the installation bracket, the equipment may fall and personal injury may result.
(Page 1-14)
- When you install the equipment on the vertical installation bracket, do not use the cover screws to secure the equipment. If you use the cover screws, the equipment may fall and personal injury may result.
(Page 1-18)
- When procuring an AC power cord, make sure that the cord has proper rating and meets local safety requirements whatever applicable. Otherwise, an electric shock or machine failure may result.
(Page 1-22)
- Before you clean or replace the dust filter or the case fan of this equipment, make sure you shut down the OS, turn off the main power of the equipment, and wait for at least one minute.
Otherwise, the injury of hands and fingers may result.
(Page 6-1)
- Do not directly touch the parts inside the equipment with your hand when installing or removing. Those parts are hot and if you touch them, you may get burned. In addition, if you touch them, they may get damaged and that may result in failure of the equipment.
(Page 6-6)



SAFETY INSTRUCTIONS (Continued)

- When you install the cover of the equipment, do not put your fingers inside the cover. If you do, your fingers may get caught and injured.
(Page 6-7)

- If you bend the tab of the grounding spring at the slot by mistake when you remove an extension board, be careful not to cut your fingers when you fix the bend because the tab has a sharp edge.
(Page 6-10)

- When you install or remove a HDD, make sure you do not cut your fingers on the protrusions.
(Page 6-15)

- When you install or remove a DVD drive, make sure you do not cut your fingers on the protrusions.
(Page 6-18)

- Rack-mounting metal fittings are designed to be used for pulling out the equipment toward the front by hooking your fingers on the handles. Do not grip the handles to lift up or carry the equipment. If you do, the equipment may fall and personal injury may result.
- Thoroughly check if the rack-mounting metal fittings are attached properly. If they are not attached properly or the screws are loose, the equipment may fall and personal injury may result.
(Page 6-20)

- When you install the equipment on the vertical installation bracket, do not use the cover screws to secure the equipment. If you use the cover screws, the equipment may fall and personal injury may result.
(Page 6-23)



SAFETY INSTRUCTIONS (Continued)

- This equipment uses a lithium battery. When you replace the lithium battery, make sure you replace it with one specified by the Manufacture. Otherwise, an explosion, a fire, a burst battery, heat generation, a liquid spill, or gas generation may result.
- Install the battery in correct polarity. Installing it in wrong polarity may cause abnormal reaction such as charging or shorting, resulting in a liquid spill, heat generation or a burst battery.

(Page 6-25)

- Do not directly touch the parts inside the equipment with your hand when you install or remove a jumper socket. Those parts are hot and if you touch them, you may get burned. In addition, if you touch them, they may get damaged and that may result in failure of the equipment.

(Page 6-27)



SAFETY INSTRUCTIONS (Continued)

2.3 Safety Warning Indicated as “NOTICE”

- Depending on the type of failure, important files may be lost when you use this equipment. Files can be lost by power failure and human mistakes during operation in addition to the failure of the equipment. If such a situation occurs, the files cannot be recovered. In order to prevent data loss, make it a routine to save your files and establish a systematic schedule for backing up files.

(Page iii) (Page C-8)

- Before you move this equipment, make sure you shut down the OS, disconnect the plug of the power cord from the outlet, and wait for at least one minute. If you do not, the HDDs and other devices may fail.
- When you transport or carry the equipment, pack it in a dedicated container (the container and packing materials used when the equipment was delivered). If you use other container or packing materials, that may damage the equipment.
- Do not use damaged or broken dedicated container when you transport or carry the equipment. If you do, that may damage the equipment.
- Due to the property of inrush current restraint method with this equipment, inrush currents may increase than usual if the power is turned on before the power supply unit has sufficiently cooled off naturally after the power has been turned off. Before you turn on the power again, wait at least one minute after you have turned off the power. Otherwise, the inrush currents may affect the breaker connected to the equipment and also the life span of the equipment itself.

(Page C-1)

- Never hot-swap HDDs because that may cause failure of the equipment and HDDs. Before you replace an HDD, make sure you shut down the OS, turn off the main power to the equipment, and wait for at least one minute.
- When using a USB port, check the orientation of the USB connector, and then insert the connector slowly. Otherwise, the USB port may be damaged.
- Do not remove or insert a USB device during online operation (system operation) because that may affect currently running applications.
- If you insert or access a CD or DVD, the system load may increase and running applications may be affected. Do not insert or access an optical disc during online operation (system operation).

(Page 1-4)



SAFETY INSTRUCTIONS (Continued)

- Before you move this equipment, make sure you shut down the OS, disconnect the plug of the power cord from the outlet, and wait for at least one minute. If you do not, the HDDs and other devices may fail.
- When you transport or carry the equipment, pack it in the dedicated container (container and packing materials used when the equipment was delivered). If you use other container or packing materials, that may damage the equipment.
- Do not use damaged or broken dedicated container when you transport or carry the equipment. If you do, that may damage the equipment.

(Page 1-14) (Page 6-1)

- Do not route the interface cables, etc. (including cables for other devices such as a PC) near the power cord. If you do, a failure or malfunction of the equipment may result.
- Do not connect or disconnect an interface cable while the power for this equipment or for the remote device is on. If you do, failure of the equipment may result due to a short circuit between the power supply and the ground. When an interface cable comes off while the power for the equipment is on, shut down the OS and disconnect the power cord from the outlet. Disconnecting the power cord from the outlet without shutting down the OS might destroy the internal files.
- When you connect a cable for external contacts, make sure you connect the cable to a connector for the external contacts (EXT). It is possible that a voltage as high as 40 VDC can be applied to the cable through a relay load. If you connect the cable to the wrong connector, that may cause failure of the equipment.

(Page 1-19)

- Performing emergency shutdown (that is, unplugging the power cord from the outlet or shutting off the breaker without proper shutdown of the OS) may cause the OS or applications not to work properly or may cause saved data to be corrupted. Do not perform emergency shutdown unless you must stop the system immediately due to some kind of error.
- If you turn off the power at the source of AC the power, the system may not be able to recover automatically.

(Page 2-4)



SAFETY INSTRUCTIONS (Continued)

- If you insert or access a CD or DVD, the system load may increase and running applications may be affected. Do not insert or access an optical disc during online operation (system operation).
- When you finish accessing a CD or DVD, eject the disc from the DVD drive. If you leave the disc in the DVD drive, failure may result.
- If you keep the disc tray open, failure may result. When you do not intend to use the DVD drive, keep the disc tray inside the DVD drive.
- Do not use an unbalanced CD or DVD due to attached labels and so on; a disc with cracks, scratches, or vertical deviation; or a disc with a non-standard shape. If you do, an abnormal sound or vibration may be generated and failure of the equipment may result.

(Page 2-5)



SAFETY INSTRUCTIONS (Continued)

- If you wash a dust filter, dry it completely before re-attaching it to the equipment. If you use the equipment while its dust filter is not completely dry, the equipment may fail. When you use a detergent to clean a dust filter, make sure you use a neutral detergent. If you use other types of detergent, the dust filter may lose its function.

(Page 6-2)

- Make sure you disconnect all external cables connected to the equipment before you install or remove an extension board. Otherwise, failure of the equipment may result.

(Page 6-8)

- Make sure you disconnect all external cables connected to the equipment before you install or remove main memory. Otherwise, failure of the equipment may result.

(Page 6-12)

- The orientation of a main memory module on a connector is fixed. When you install a main memory module, make sure the orientation is correct. Otherwise, failure of the equipment may result.
- Do not install main memory modules with different capacities on slot A2 and slot B2. If you do, the modules may not be recognized.

(Page 6-13)



SAFETY INSTRUCTIONS (Continued)

- Put the HDD on a shock-absorbing material such as an antistatic cushion even for a temporary task. If you put an HDD directly on a hard surface such as a desktop, a failure or a shorter life span of the unit or loss of data may result due to possible jarring or shock.
- Never remove the screws on an HDD while the power to the unit is on. Never hot-swap HDDs. If you do either of these, failure of the equipment or the drive may result.
- Before you replace an HDD, make sure you shut down the OS, unplug the power cord from the outlet, and wait for at least one minute.
- When you replace an HDD to recover from a failure in one HDD with the power of the equipment turned on, see “10.4.2 Recovery from a failure in one HDD”.
- Install or remove an HDD only if necessary, for example, when you need to replace an HDD due to failure. If you do it frequently, failure of the equipment may result.
- Fully insert an HDD. Loose contact and missing screws may result in failure.
- Do not give a shock to an installing HDD and the already mounted HDD during installing. If you give a shock to an HDD, failure of the drive may result.

(Page 6-15)

- Make sure you do not apply too much force to the connector of the DVD drive and the top of the DVD drive. If you do so, failure of the DVD drive may result.

(Page 6-18)

- The orientation of a rack-mounting metal fitting is fixed if it is to be attached to the equipment. Make sure the orientation is correct.

(Page 6-20)



SAFETY INSTRUCTIONS (Continued)

- A recovery DVD contains an image file created for the hardware configuration at the factory shipment. If the hardware configuration has changed from the one at the factory, the OS may not start after restoration work. Remove all external storage devices to resume the hardware configuration at the factory shipment before you perform restoration work using a recovery DVD.
When a recovery DVD is used, all data in the system drive is deleted. Back up the data beforehand as required.

(Page 7-1)

- Although this Equipment featuring RAID1 is more reliable than general systems, it is still prone to the loss of data in the HDDs. Not only a machine failure but also an unexpected power failure or an operation error may cause data to be lost for good. To prevent such loss of data, implement scheduled data backup in daily operation. Also, protect the power source from undesirable interruptions by such means as UPS.
- This Equipment is evaluated based on the specific HDD models authorized by the Manufacturer. Replace only with specific HDD models authorized by the Manufacturer. Otherwise, the existing data in the HDD may be lost. Also, always observe the recommended replacement interval for HDDs (Refer to “APPENDIX HANDLING REPLACEABLE COMPONENTS”).
- When HDD1 and HDD2 are installed, their capacities must be the same. Do not install HDDs with different capacity.
- As a replacement HDD, do not use an HDD previously used. If you do, this equipment may not operate properly or the data on the HDDs may be lost because of configuration information mismatches or other reasons.
- Since each Equipment has its own RAID1 configuration information (e.g., serial number), you cannot swap HDDs even between two units of this Equipment. If you dare, the stored data in the newly installed HDD will be erased with automatic RAID1 rebuilding process due to inconsistency of the RAID1 configuration information. If you own multiple units of this Equipment, manage use and inventory of HDDs so that they are not inadvertently mixed.
- Maintenance of a RAID1 system requires a high level of expertise. Should any mistakes be made during the work, the data stored on the HDDs may be lost.

(Page 10-1)



SAFETY INSTRUCTIONS (Continued)

- When RAID 1 is newly configured, RAID 1 configuration information corresponding to only one equipment being used is recorded on the HDD. The HDD with configuration information recorded can not be used with other equipment, so users who use multiple equipment, should be careful not to handle and store HDDs to not to mix.
If HDDs are mixed, the RAID 1 configuration information may be inconsistent, the equipment may not operate normally, or the data in the HDD may be lost.
- When you build a RAID1 system from scratch, prepare two new HDDs selected from the models specified and tested by HITACHI. Otherwise, the data stored on the HDDs may be lost.

(Page 10-3)

- Never remove an HDD when the HDD status lamp of the HDD is OFF. If you do, the data stored in the HDD gets corrupted.
- Wear cotton gloves when replacing an HDD in order to prevent problems caused by static electricity. If you do not, the data stored on the HDD may get corrupted.
- Make sure you check the correct procedure before you start the work. If you do not follow the correct procedure, the data stored on the HDD may be lost.
- As a replacement HDD, do not use an HDD previously used. If you do, this equipment may not operate properly or the data on the HDDs may be lost because of configuration information mismatches or other reasons.
- Mount an HDD securely. Loose contact and missing screws may result in a failure.
- Do not subject an HDD you are mounting and the already mounted HDDs to shock while replacing an HDD. Otherwise, failure of the drive may result.
- Until the rebuild is complete, avoid shutting off the power for this equipment or attaching and detaching HDDs. Otherwise, the data on the HDDs may be lost or a failure may result.

(Page 10-7)



SAFETY INSTRUCTIONS (Continued)

- Wear cotton gloves when replacing an HDD in order to prevent failure caused by static electricity. If you do not, the data stored on the HDD may get corrupted.
- Make sure you check the correct procedure before you start the work. If you do not follow the correct procedure, the data stored on the HDD may be lost.

(Page 10-15) (Page 10-16)

- Wear cotton gloves when replacing an HDD in order to prevent failure caused by static electricity. If you do not, the data stored on the HDD may get corrupted.
- Make sure you check the correct procedure before you start the work. If you do not follow the correct procedure, the data stored on the HDD may be lost.
- As a replacement HDD, do not use an HDD previously used. If you do, this equipment may not operate properly or the data on the HDDs may be lost because of configuration information mismatches or other reasons.
- Do not replace the two HDDs at the same time. If you do, the data gets corrupted.
- When you replace an HDD, make sure that you set the HDD into the offline mode in the Hardware status window, and then remove that HDD and mount the replacement HDD. If you mount or remove an HDD when the hardware status cannot be checked, for example, immediately after the OS starts, a failure may result.

(Page 10-17)

- Do not use a replaceable component for longer than the recommended replacement cycle. If you do, a deteriorating or worn-out component may cause the equipment to fail.

(Page A-1)





SAFETY INSTRUCTIONS (Continued)

3. WARNING LABELS

The warning labels are attached to the following position on the equipment.
Please never peel off or stain these labels.

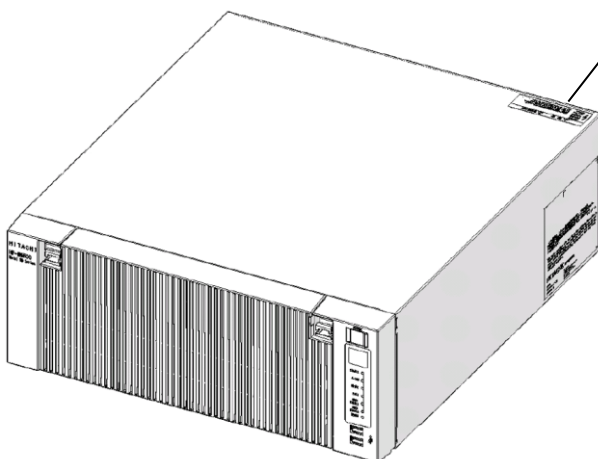
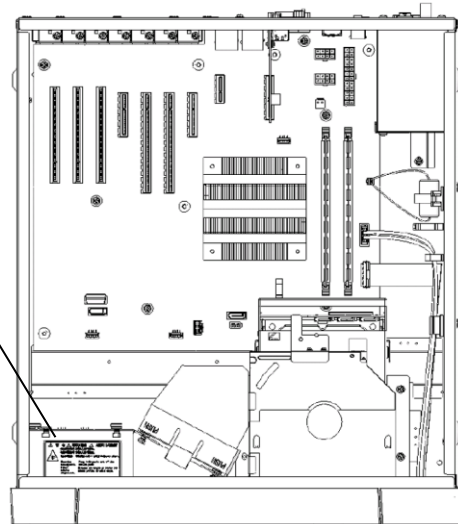
 警告	 WARNING	 AVERTISSEMENT
危険的运动部件	手指和人体不要靠近。	手指和人体不要靠近。
危険的运动部件	手指和人体不要靠近。	手指和人体不要靠近。
 危険な可動部	可動部位に人体の一部を近づけないでください。	可動部位に人体の一部を近づけないでください。
Hazardous moving parts.	Keep body parts out of the motion path.	Keep body parts out of the motion path.
Pièces mobiles dangereuses.	Éloignez vos doigts et toutes les autres parties de votre corps.	Éloignez vos doigts et toutes les autres parties de votre corps.



 警告	 WARNING
 危険电压	触电会导致死亡或重伤。揭开盖子前，请从插座拔掉电源线。
危険電壓	觸電會導致死亡或重傷。打開蓋子前，請從插座拔掉電源線。
危険電壓	感電による死亡または重傷の恐れがあります。カバーを外す前に、電源ケーブルをコンセントから抜いてください。
Hazardous voltage.	Can cause death or severe injury. Pull out power cord from the outlet before opening the cover.



SAFETY INSTRUCTIONS (Continued)

4. PRECAUTIONS WHEN YOU USE THE LASER

The DVD drive uses a laser.

Do not look into the laser beam, whether directly or indirectly, because that may cause a visual impairment.

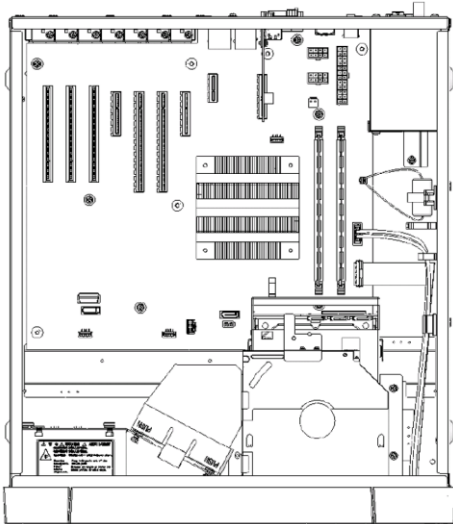

5. NOTICE LABEL

The notice label is attached to the following position on the equipment.

通知 NOTICE

当您更换驱动器设备的启动过程中，系统数据将被销毁。请参阅用户手册。
當您更換驅動器設備的啟動過程中，系統資料將被銷毀。請參閱使用者手冊。
装置の電源が入った状態でドライブの挿抜を実施すると、システムデータ破壊にいたりますので、取扱説明書に従いドライブの交換を実施してください。
Drive replacement during startup of the device, corrupts the system data. See User's Manual.

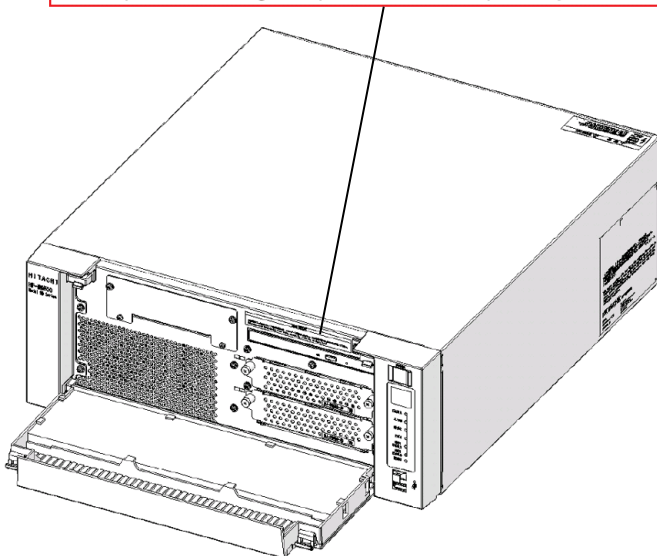



SAFETY INSTRUCTIONS (Continued)

6.  **DISPOSING THE EQUIPMENT**

This Equipment contains materials potentially harmful to environment if improperly abandoned. When you dispose of this Equipment, observe local laws and regulations whatever applicable.

7. **EU BATTERY DIRECTIVE (2006/66/EC)**

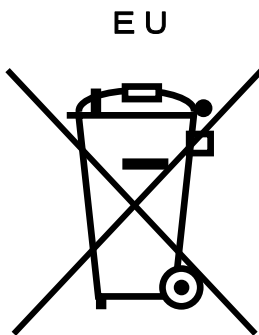

This symbol mark is valid in countries inside the European Union. This symbol mark is specified in Article 20 “Information for end-users” and Annex II of the EU directive 2006/66/EC.

This equipment is equipped with a lithium battery. When you remove the battery, follow the instructions in the “6.4 Removing the lithium battery”. In the European Union, a separate collection system for used battery and accumulator has been in place. Process batteries and accumulators appropriately at a local collection/recycle center.

This Page Intentionally Left Blank

PRECAUTIONS

1. PRECAUTIONS ABOUT THE EQUIPMENT

NOTICE

- Before you move this equipment, make sure you shut down the OS, disconnect the plug of the power cord from the outlet, and wait for at least one minute. If you do not, the HDDs and other devices may fail.
- When you transport or carry the equipment, pack it in a dedicated container (the container and packing materials used when the equipment was delivered). If you use other container or packing materials, that may damage the equipment.
- Do not use damaged or broken dedicated container when you transport or carry the equipment. If you do, that may damage the equipment.
- Due to the property of inrush current restraint method with this equipment, inrush currents may increase than usual if the power is turned on before the power supply unit has sufficiently cooled off naturally after the power has been turned off. Before you turn on the power again, wait at least one minute after you have turned off the power. Otherwise, the inrush currents may affect the breaker connected to the equipment and also the life span of the equipment itself.

(1) TRANSPORTING THE EQUIPMENT

<Required actions>

- When you transport or carry the equipment, pack it in a dedicated container (the container or packing materials used when the equipment was delivered). When you transport or carry the equipment in a chassis, protect the equipment so that any vibration and shock the equipment is subjected to is within the specifications provided.
- Keep a dedicated container (the container or packing materials used when the equipment was delivered). You can then use them later when the equipment is transported or carried.

(2) INTERFACE CABLES

<Precautions>

- Do not pull on a cable with excessive force.
- In order to meet the EMC standards (FCC, CE, VCCI), use shielded cables for the interface cables (display interface cable, keyboard interface cable, and mouse interface cable) connected to the equipment.

<Required actions>

- Route the cables in a neat and orderly manner alongside the device so that those cables do not catch on hands or feet. If the power cord is disconnected during operation of the equipment and the power is lost, crucial data stored on the hard disk may be break.

(3) CONNECTOR

<Precautions>

- In order to connect a connector properly, you need to insert it with the proper orientation and at the proper angle. If a connector is not inserted properly, the connection may fail or malfunction.
- Make sure there are no loose I/O cable connectors on the equipment.

(4) POWER SUPPLY

1. Power Voltage

<Required actions>

- Confirm that the voltage of the power input to the equipment is within the specified range (100Vto240VAC). If the voltage of the power input is close to the upper or lower limit of the specified range, you should treat it as you would a setting error of the input voltage and ask the manager of the power facility to inspect the voltage output by the facility

2. Power Cord

<Precautions>

- The power cord that comes with the equipment is rated at the input voltage of 125 VAC. When using this equipment at over 125 VAC, prepare the power cord fitting input voltage and inspect the safeness of this equipment enough.
- Install D class grounding (previously known as third class grounding) defined in the Technical Standard for Electrical Facilities of Japan in order to maintain normal operation of electronic circuits containing highly integrated LSIs and protect device from abnormal voltage caused by lightning or the like.
- Use a power cord with a 2-prong plug and a grounding pole. (See“1.7 Hardware connection”.)
- When you connect the plug of the power cord to an outlet, make sure you use an outlet with a neutral pole that is properly grounded. In addition, you must install and use an earth leakage circuit breaker.
- If you use a power cord clamp to prevent accidental disconnection, give an extra length to the power cord when you fix the cord, in order to allow the cord to be disconnected in an emergency. Alternatively, install an emergency circuit breaker at the outlet side.
- Do not put any object on the power cord. In addition, do not install signal lines near the power cord.

3. Turning the Power On and Off

<Precautions>

- When you turn off the power, turn off the main power switch on the rear of the equipment. (See “1.7 Hardware connection”.)
- Wait for at least one minute before turning the power on again after turning it off. If you wait for less than one minute, the equipment may not operate as specified by the BIOS power setting. (Refer to the “5.6 BIOS Setup”.)
- Do not turn off the power to the equipment or press the reset switch during communication or while a CD or DVD or an HDD is being accessed.

<Required actions>

- When you connect or disconnect a peripheral, make sure both the equipment and the peripheral have been turned off. Otherwise, a malfunction or failure may result.
- When you turn on the power, turn on the peripherals first and then turn on the equipment. When you turn off the power, turn off the equipment first and then turn off the peripherals.
- When you are not using the equipment, turn off the power. If you do not intend to use the equipment for a long time, unplug the power cord from the outlet.
- Depending on the material, a rug, a lap blanket, or the like may cause static buildup and consequently cause a malfunction of the equipment. Use a conductive rug or lap blanket resistant to static buildup.
- Instantaneous power failure or brownout may occur during operation and the screen may black out when lightning strikes nearby or the AC power supply is not stable. When this situation happens, turn off the power to the equipment and then turn it back on.

(5) INSTALLATION ENVIRONMENT

<Precautions>

- When you install a commercially extension slot, the specifications for the required environment for both the commercially available device and this equipment must be met. (See “1.6.1 Environment”.)
- When you install a device in the extension slot, make sure the power consumption does not exceed the maximum current rating. (See “5.1(9) Maximum current specifications”.)
- In order to use this equipment without failure for a long period of time, you must use it with proper care and in the proper environment. Do not use the equipment in the locations described below. If you do, the life span of the equipment may be reduced and failure of the equipment may result.

- In a place subject to exposure to direct sunlight.....Too close to a window
- In a place subject to rapid temperature or humidity change.....Too close to an air conditioner
- In a place close to device that generates electrical noise.....Too close to electric motors and generators
- In a place close to device that generates a strong magnetic field.....Too close to magnets or the like
- In an environment full of dust
- In a place subject to vibration
- In an environment with corrosive gasses present
- In a place with vibration caused by loud sounds.....Too close to device that generates a loud buzzer or alarm

- The following are precautions for the left, right, top, and bottom sides of the equipment:
 - Do not attach heating devices.
 - For ease of maintenance work, make sure that the Equipment can be moved easily; if fixed, ensure that the Equipment can be removed easily.
- It is reported that zinc whiskers can cause a problem with the device. Do not use electrogalvanized material near or at the place where the equipment is installed.

(A quote from the Technical Report of JEITA(*) ITR-1001 “Guideline of Facilities and Equipment for Information Systems”)

Location of whiskers: Whiskers are created by electrogalvanized equipment such as floor panels, stringers, posts, aseismatic flat steel, and the like.

Phenomenon: Hair-like zinc crystals (conductive whiskers) float into the air from the floor for some reason, go inside the device, and short-circuit a PCB or its pins. The root cause is difficult and time-consuming to find because the symptom differs depending on the location of the short circuit, and often, it is mistaken for a temporary issue.

(*) JEITA : Japan Electronics and Information Technology Industries Association

<Required action>

- If you mount the equipment in a chassis or on a desk, the temperature increase around the equipment needs to be taken into consideration.
- The system clock and the like inside the equipment always operates using a backup battery even when the power is off. Therefore, if you store the equipment at a temperature outside the operating temperature range, you may need to reconfigure system BIOS settings including the clock settings, when you start using the equipment again. When you reconfigure system BIOS settings, follow the instructions in “5.6 BIOS Setup”.

(6) OPERATING CONDITION

<Precautions>

- Before you move the equipment, be sure to disconnect the plug of the power cord from the outlet and wait at least one minute.
- In order to prevent moisture condensation, when you move the equipment from outside the building to inside, wait for at least four hours before using the equipment.
- The equipment is made of precision electronics components. Do not subject the equipment to any vibration or shock.
- Do not sit on the equipment nor place anything on the equipment.
- During normal operation, do not turn off the display. Set it into the standby mode instead.
- During normal operation, do not touch the keyboard or mouse until the logon screen is displayed when you turn on the equipment.

<Required action>

- We recommend that you remove the dust built up in the neighborhood of the device (in particular, below the device), in the vents on the device , and on the front of the device itself.

(7) ABNORMAL SOUNDS

<Specifications>

- When the power is turned on, you may hear a low-frequency humming noise. This is caused by transient low-frequency vibrations of the chokes for suppressing high-frequency noise or other components and does not affect the characteristics and life span of the equipment.

(8) WARRANTY

<Specifications>

- The Manufacturer cannot guarantee for damage to data or application software caused by hardware damage to the equipment.
- Use an operating system specified by the Manufacturer. The Manufacturer cannot guarantee proper operation of the equipment if you use an operating system not specified by the Manufacturer.
- This equipment is evaluated under the assumption that the hardware specified by the Manufacturer is used. Therefore, when you install or replace hardware, use the hardware specified by the Manufacturer. The manufacturer cannot guarantee proper operation of the equipment if you use other hardware.

2. NETWORK

<Precautions>

- When you send a Magic Packet™ frame, make sure the standby lamp of the equipment is on. If you send a Magic Packet™ frame when the power is about to be turned off after an OS shutdown, the equipment may restart without being turned off or wake on lan (WOL) may not function at all. (See “2.7.2 Turning on the power using the LAN”.)

<Specifications>

- Depending on the status of the network, Magic Packet™ frames can be lost. In order to avoid this, set up the system so that Magic Packet™ frames can be propagated without loss. (See “2.7.2 Turning on the power using the LAN”.)
- Even though a network drive may be configured to be reconnected at logon, sometimes the reconnection may fail. If this happens, log on again or use the net_use command to establish the connection.
For information about the net use command, see the Windows® help.
- If the settings of the hub and the network adapter do not match, the performance of the network adapter may be compromised or the network adapter may not work properly. (See “2.8 Setting Up the LAN Interface”.)
- The electric potential difference between units can generate heat. Therefore, do not use twisted-pair Ethernet cables (such as category 5 or STP cables) for network connections other than the ones specified in “5.9.1 Connector specifications (1) Motherboard (Standard)”.

3. DISPLAY SCREEN

<Specifications>

- Before you set up the screen, terminate all running application software.
- When you change connections to switch between single- and multi- display configurations, turn off the power to the equipment, change the connection of display cables, turn the power back on, and then set up the screen configuration.
- When you change the connection configuration for the displays, reconfigure the screen settings accordingly.
- Depending on application software, the screen may flicker and video playback may not be smooth.
- If a display unit connected with DisplayPort is turned off, the display cannot be detected.
- DisplayPort audio output is not supported.

(The display image assumes Windows® 10 but it is similar under other OS.)

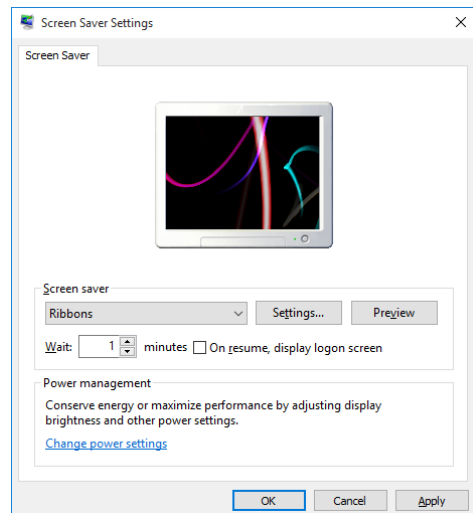
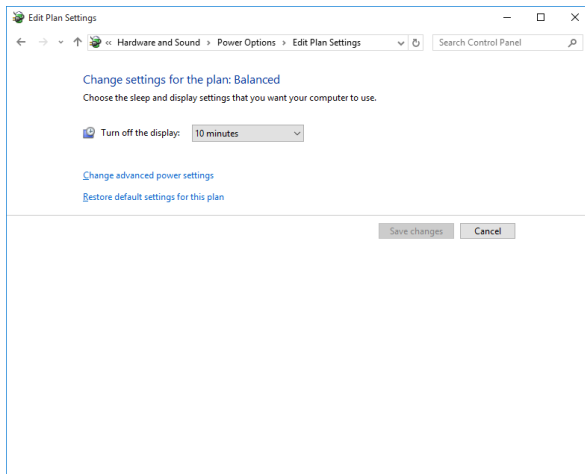

<Required action>

- If you want to enable "Collage" for multiple displays, use displays that support Display Data Channel (DDC). When you use displays that do not support DDC, you cannot enable "Collage".

4. HARD DISKS DRIVES (HDDs)

NOTICE

Depending on the type of failure, important files may be lost when you use this equipment. Files can be lost by power failure and human mistakes during operation in addition to the failure of the equipment. If such a situation occurs, the files cannot be recovered. In order to prevent data loss, make it a routine to save your files and establish a systematic schedule for backing up files.

(1) Handling the Hard Disk Drives

<Precautions>

- The access performance of the HDDs differs depending on the equipment. Also note that the performance of an HDD is lower at high or low temperatures. When you use HDDs, confirm that the access performance of the HDDs at normal temperatures and their degraded performance at high or low temperatures do not cause any problems to the user application.

<Required actions>

- Do not subject HDDs to vibration or shock.
- Take preventive action against static electricity due to human contact, and due to other activities in the work place.
- Hold the bracket or sides of an HDD. Do not touch the printed circuit board and connector.
- When you store an HDD for a long time, put the HDD into an anti-static bag and then store it in a dedicated box.

<Specifications>

- When you modify existing partitions, delete the partitions first and then re-create them.
- The capacity and performance of an HDD may be changed when you replace an HDD as a component.

(2) Backing Up Files

<Required actions>

- Make sure the contents of all HDDs are backed up periodically.
- When you delete a partition, all files in the partition will be deleted. Before you delete a partition, back up important files you need.

5. DVDs

(1) Handling the DVD Drive

<Precautions>

- The DVD drive is subject to damage by dust. Install the equipment in a place with minimum dust and clean up around the equipment regularly.
When you use insecticide sprays or the like, cover the equipment with a protective sheet or covering beforehand.
- Do not subject the equipment to a strong shock while the DVD drive is in use.
- Do not open the tray except when you insert or eject a CD or DVD. Do not put foreign objects into the tray. Doing so might damage or break the DVD drive.
- When you put a CD or DVD on the disc tray, make sure that the disc is properly set on the disc tray. If not, the disc may be forced out of the tray.

<Specifications>

- Depending on the type of CD or DVD used, you may not be able to read or write to the disc. In this case, use another CD or DVD.
- Depending on the condition of a CD or DVD (whether it has scratches, dust, is deformed, has copy protection enabled, and so on), you may not be able to read or write to the CD or DVD properly.

(2) Handling CDs and DVDs

<Precautions>

- Do not apply benzene, thinners, water, record cleaner, anti-static liquids, or use a silicone cloth on a CD or DVD.
- Do not use a dryer when you remove dust or moisture from a CD or DVD.
- Do not store a CD or DVD in a location with high temperature and humidity.
- Do not store a CD or DVD in a location subject to direct sunlight or strong artificial light.
- Do not fold or bend a CD or DVD.
- Do not write on or scratch the recording surface of a CD or DVD.
- Do not insert a stick into a center hole of a CD or DVD and spin the CD or DVD.
- Do not put stickers, labels, or decals on a CD or DVD.

<Required actions>

- If a CD or DVD is dirty, wipe it with a soft dry cloth in the direction from the center to the rim.

6. USB DEVICES

<Precautions>

- When you start using a USB device, test the device before using it. Never use a USB device for mission critical use.
- Do not connect a USB device during the OS startup because the OS may not start normally.
- If you switch screens during OS startup when you use a CPU/USB KVM switch, the OS may not start normally depending on the type of the CPU/USB KVM switch. When you use a CPU/USB KVM switch, make sure you test its operation thoroughly.
- For USB 2.0 and USB 3.0, the length of the cable used must be less than or equal to the length specified in the specifications. Otherwise, the transfer speed may be compromised. Use a USB 2.0 or USB 3.0 cable that matches the device you use. Otherwise, the actual transfer speed of the device may not be as high as it should be, or communication errors may result. For information about the cable specifications, ask the manufacturer of the cable. (For information about the cable length, see “5.9.3 External interface cable length specifications”.)

<Required actions>

- When using a USB port, check the orientation of the USB connector, and then insert the connector slowly in order not to damage the USB port.
- When a USB device is inserted, removed, or accessed, the system load may be increased. If you need to use a USB device during online operation (system operation), you must confirm that using the device does not affect the currently running application software before using the device.
- After you clean a USB keyboard, check the connection between the equipment and the connector of the keyboard. A loose connection may cause the keyboard to be recognized incorrectly or prevent the system from starting normally.

<Specifications>

- It is not guaranteed that all USB devices can be connected.
- Some USB devices do not conform to the USB specifications. If you turn off the main power while a non-compliant USB device is connected, the equipment may not start properly and the clock setting may be corrupted. When you select a USB device, make sure you test its operation thoroughly.

7. EXTENSION BOARDS

<Required actions>

- If an extension board (PCI Express/PCI board) is supplied by a user, the user must take responsibility for confirming that each component on the board meets the operating temperature specification when those parts heat up.
- After you install an extension board, make sure you save the dummy bracket, and store it in a safe place.

8. RACK-MOUNTING METAL FITTINGS

<Precautions>

- When the equipment is mounted on a rack with rack-mounting metal fittings, do not put anything on the equipment. In addition, do not put a load (for example, an object) on the cover of the equipment.
- When you mount the equipment on a rack mount, for safety reasons, we recommend you use a combination of rack-mounting metal fittings, a shelf board for a rack mount, and slide rails. (See “1.6.2 Installation”.)

9. LITHIUM BATTERIES

<Required actions>

- This equipment uses a lithium battery. When you dispose of the battery, observe any applicable laws and regulations.

10. OPTICAL MUSES

<Required actions>

- Due to the nature of the optical sensor, an optical mouse may not work on transparent materials or light-reflecting materials (glass, mirrors, and the like). Avoid using an optical mouse on those materials or purchase an optical mouse pad available on the market.
- If the optical sensor is smeared with condensation or oil mist, the optical mouse may not work properly. If you use an optical mouse in an environment subject to those kinds of smears, take appropriate measures to protect the equipment.

11. BIOS SETTINGS

<Specifications>

- When the main power is OFF while the power from the backup battery is not available or the battery is not connected, the “After AC Power ON” setting is switched to “Auto”. After pressing the power switch and starting the system, you can configure the “After AC Power ON” setting but because the power from the backup battery is not available, the setting is automatically switched back to “Auto” when you disconnect the power cord. (See “5.6 BIOS Setup”.)
- When the setup menu is used, the clock display may sometimes show a delay. After you finish the setup menu, make sure you confirm the clock is correct. (See “5.6 BIOS Setup”.)

12. MAINTENANCE SERVICES

<Specifications>

- Microsoft® Windows®, device drivers, and commercially available application software may not be able to be modified directly as a counter measure for a particular failure. Instead, the Manufacturer may offer a work-around as a counter measure.
- If you add new commercially available hardware to the equipment without notice to the Manufacturer, the equipment as a whole will lose eligibility for warranty.
- Some components used in the equipment (such as LSIs from Intel corporation) can not be disassembled for failure analysis because the Manufacturer does not have the right to do so.
- The price of this equipment does not cover maintenance and support. When you order the equipment, you must clarify the desired maintenance support level in the maintenance contract and make the required payment for the maintenance fee defined by the maintenance support level.

13. WINDOWS® SETTINGS

(1) Applying a Hotfix and Other Updates

<Specification>

- If you need to apply a hotfix, Windows Update, or the latest service pack, do it on your own responsibility. You must thoroughly check the system operation and evaluate how the system is affected by applying the hotfix, Windows Update, or service pack.

(2) Power Options

<Specification>

- In case of Windows® 7, even if you configured the system such that power for the display is not be turned off in the Power Options (Never is specified for “Turn off the display”), the power plan can be temporarily switched to **High performance** when the Windows Experience Index is triggered automatically and the power for the display can be turned off.

To prevent the power for the display from being turned off, go through the following step 1 to 5 to disable automatic execution of the Windows Experience Index.

- Procedure to change the settings of the Windows Experience Index
 1. Open **Control Panel** and click **System and Security**.
 2. Click **Administrative Tools**.
 3. Double-click **Task Scheduler**.
 4. From the tree in the left pane of the Task Scheduler window, select **Task Scheduler Library > Microsoft > Windows > Maintenance**.
 5. Right-click **WinSAT** displayed in the center of the window and select **Disable**.

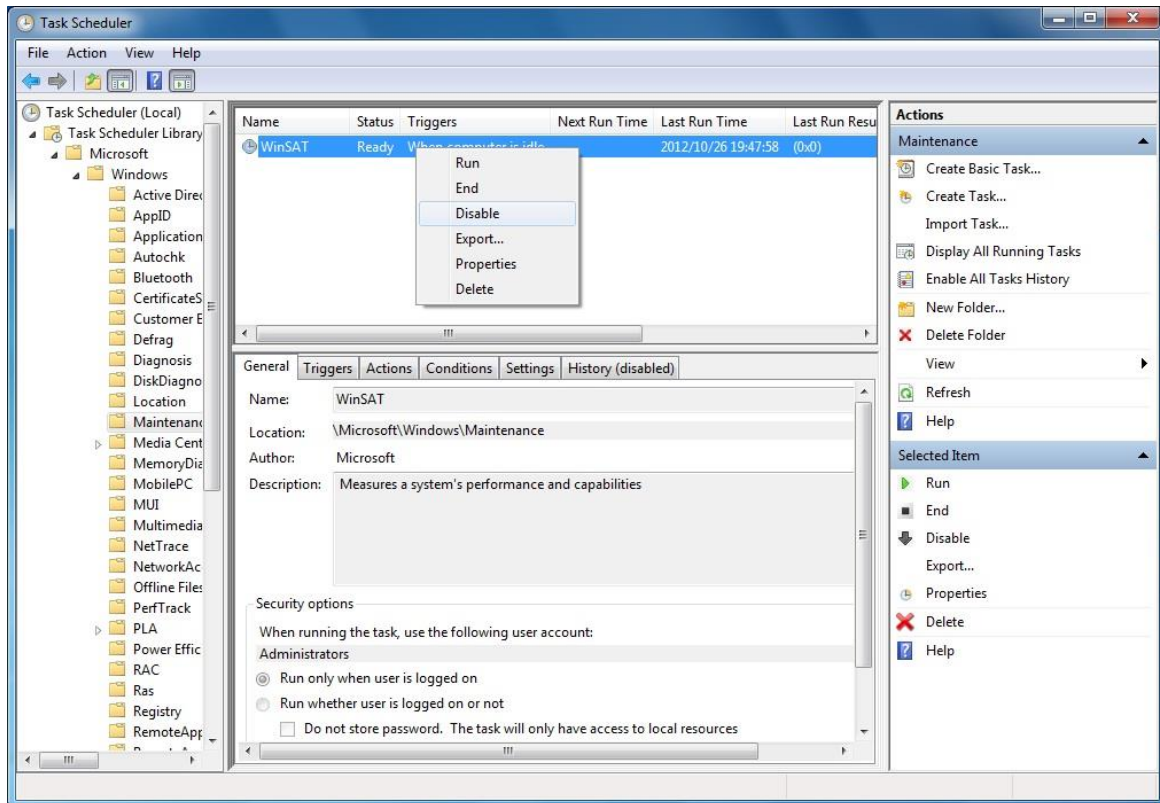

• If you follow the procedure described above to disable automatic execution of the Windows Experience Index, the Windows Experience Index may not be triggered at all or may not be triggered even after a device driver is updated or a hardware configuration is changed. If the Windows Experience Index is not triggered, Windows® may not operate in the optimum manner and the performance can be compromised. Because of this, you may need to trigger the Windows Experience Index manually.

Follow the procedure below to trigger the Windows Experience Index manually:

- Procedure required to trigger the Windows Experience Index manually
 1. Open **Control Panel** and click **System and Security**.
 2. Click **Check the Windows Experience Index**.
 3. Click **Rate this computer**. (For the second time and later, click **Re-run the assessment**.) When you see the **User Account Control** window, click **Yes**.

<Required actions>

- Do not change the factory default setting, "**HF-W Power Settings**", for the power plan. Furthermore, do not change "**Turn off hard disk after**" setting from "**0**". If you want to confirm the current setting for power plan and "**Turn off hard disk after**" setting, follow the procedure below. (The display image assumes Windows® 7 but it is similar under other OS.)
- Confirmation procedure of the current power plan settings
 1. Open **Control Panel** and click **System and Security**.
 2. Click **Power Options**.
 3. **Power Options** window appears.
 - Confirm that **HF-W Power Settings** radio button is selected under **Preferred plans**.

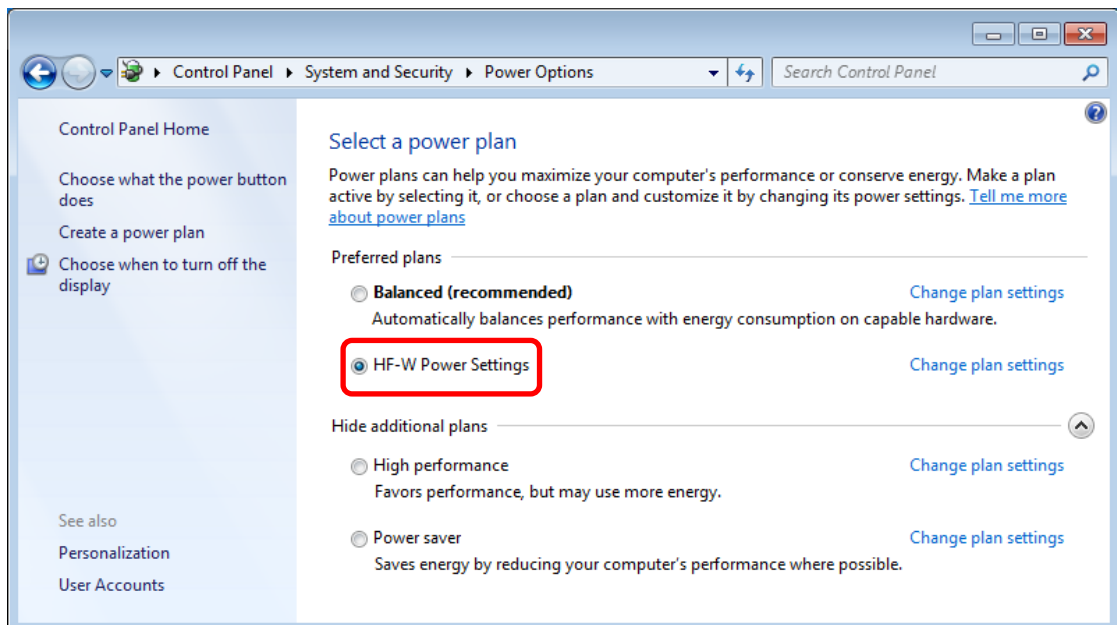

- Confirmation procedure of "**Turn off hard disk after**" setting
 1. Following the confirmation procedure of the current power plan settings, click **Change plan settings** at **HF-W Power Settings**.

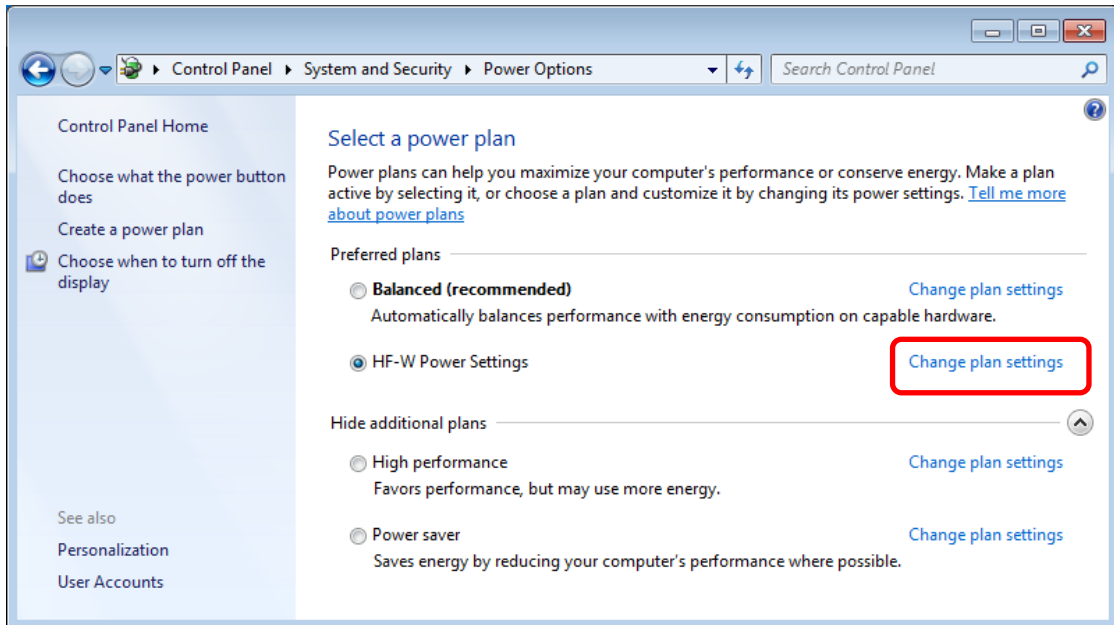

2. **Edit Plan Settings** window appears.

- Click **Change advanced power settings**.

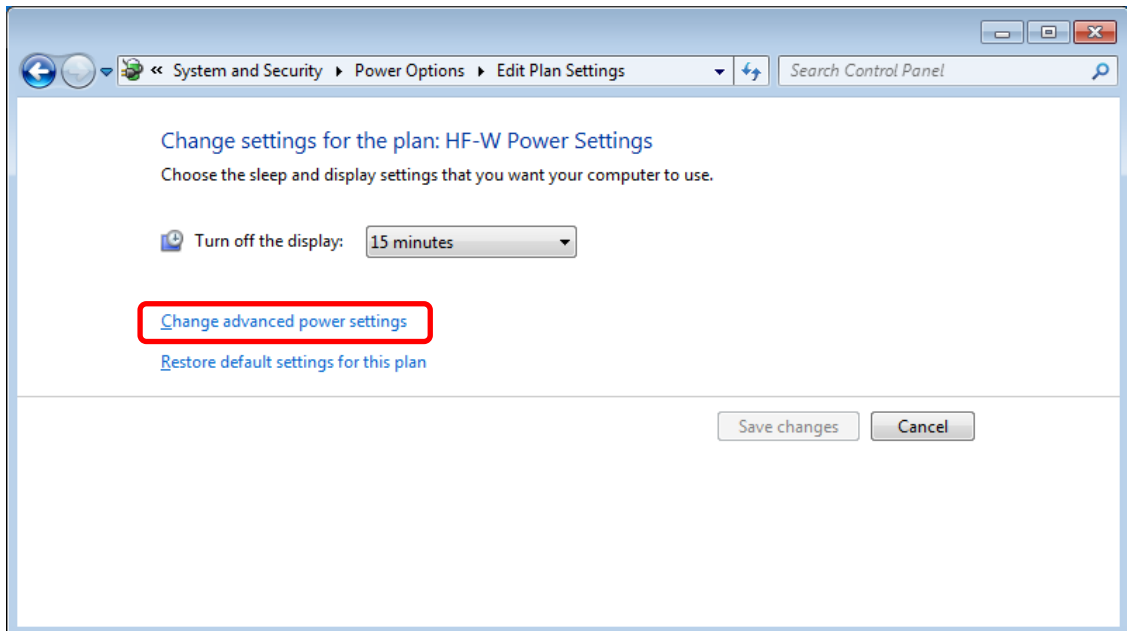

3. **Advanced setting** tab of **Power Options** appears.

- Confirm that **Turn off hard disk after setting** is "0".

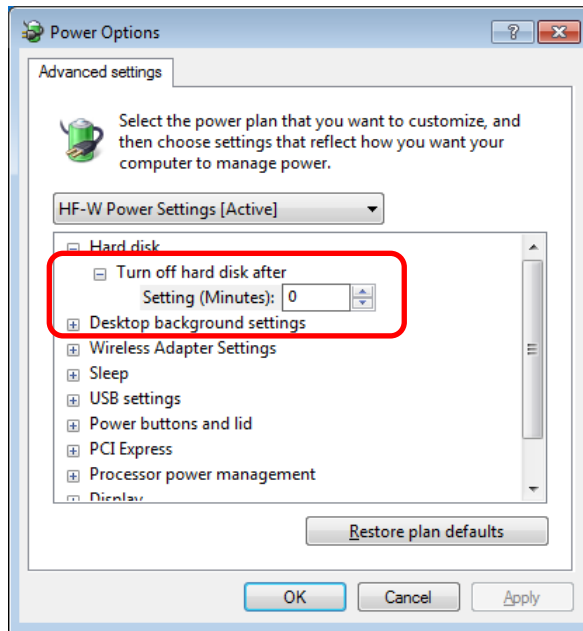

- When you change the settings from factory default setting, restore the factory default setting following the procedure below.

1. Open **Control Panel** and click **System and Security**.

2. Click **Power Options**.

3. **Power Options** window appears.

- Confirm that **HF-W Power Settings** radio button is selected under **Preferred plans**.

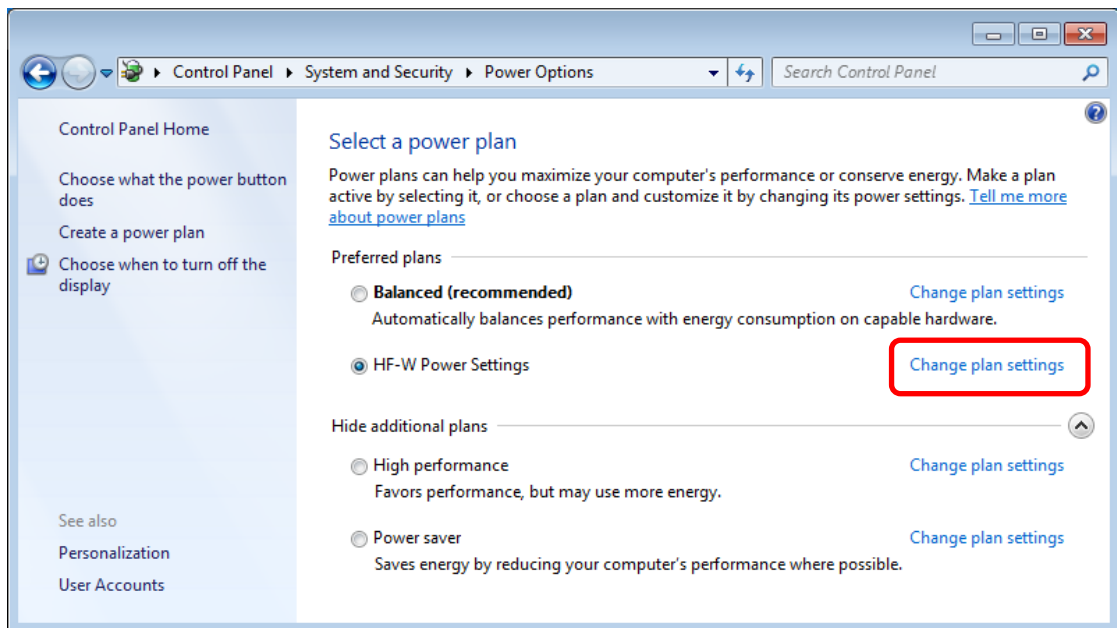

4. **Edit Plan Settings** window appears.

- Click **Restore default settings for this plan**.

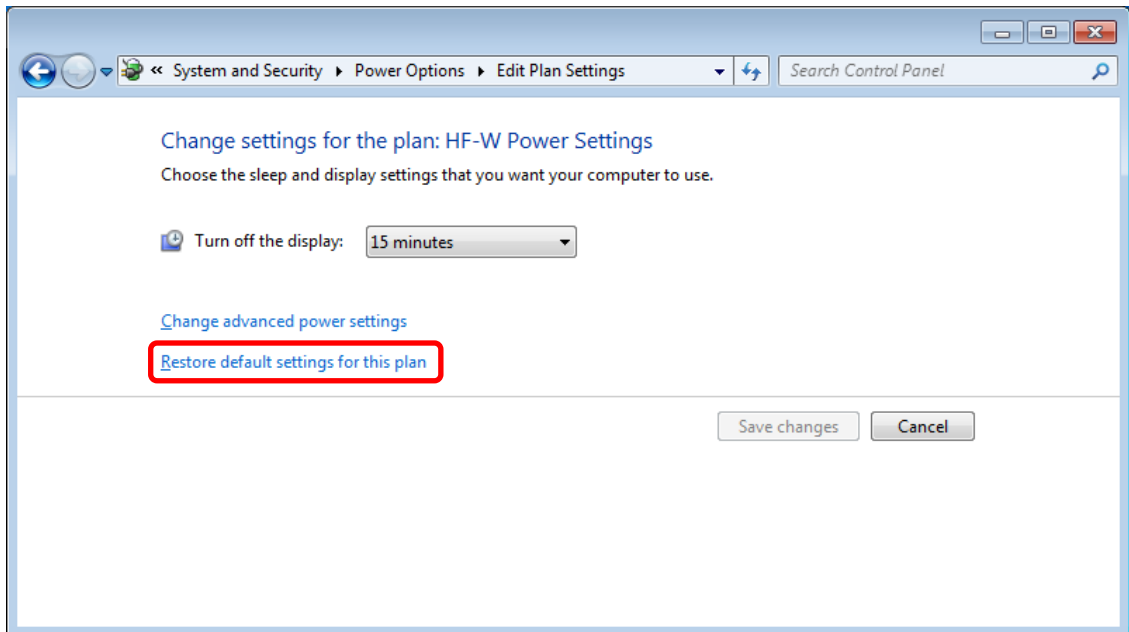

5. **Power Options** window appears.

- Click **Yes**.

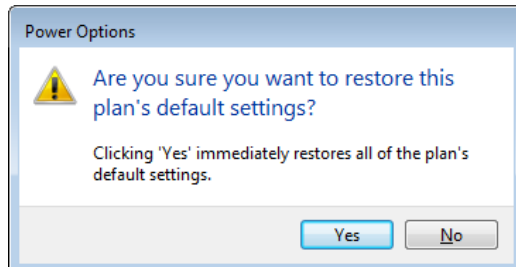

This Page Intentionally Left Blank

CONTENTS

PREFACE	i
IMPORTANT NOTIFICATIONS	iii
 SAFETY INSTRUCTIONS	S-1
PRECAUTIONS	C-1
CHAPTER 1 GETTING STARTED	1-1
1.1 Scope	1-1
1.2 Installing an Extension Board	1-1
1.3 Role of an Operator	1-1
1.4 Work Flow	1-3
1.5 Name and Function of Each Part	1-4
1.6 Installation Environment	1-13
1.6.1 Environment	1-13
1.6.2 Installation	1-14
1.7 Hardware connection	1-19
1.8 Power cord	1-22
CHAPTER 2 OPERATION	2-1
2.1 Before Turning On the Power	2-1
2.2 Starting the Equipment	2-2
2.3 Shutting Down the Equipment	2-3
2.4 Power Shutdown	2-4
2.5 Emergency Shutdown	2-4
2.6 DVD drive	2-5
2.6.1 Inserting a CD or DVD	2-6
2.6.2 Ejecting a CD or DVD	2-6
2.7 Controlling the Power Using the LAN	2-7
2.7.1 Enabling the WOL (Wake ON LAN) function	2-7
2.7.2 Turning on the power using the LAN	2-8
2.8 Setting Up the LAN Interface	2-10
2.9 Setting Up the Screen	2-22
CHAPTER 3 SETUP	3-1
3.1 Setup Procedure When You Turn On the Power for the First Time.....	3-1
3.1.1 Setting up Windows® 10	3-1
3.1.2 Setting up Windows Server® 2016	3-5
3.1.3 Setting up Windows® 7	3-9
3.2 Configuring Basic Settings after OS Setup	3-15
3.2.1 Basic Settings for Windows® 10 and Windows Server® 2016	3-15
3.2.2 Basic Settings for Windows® 7	3-21
3.2.3 Setup Procedure when using Windows XP Mode	3-27

CHAPTER 4 PRECAUTIONS WHILE THE OS IS RUNNING	4-1
4.1 Event Log Entries during Setup	4-1
4.2 Event Log Entries While the OS is Running	4-2
4.3 Scheduled Functions by Default	4-6
4.4 Security Enhancement Function	4-16
4.5 Factory-Shipped Network Settings	4-16
4.6 Product Activation in Windows® 10	4-17
4.7 Startup Repair Function	4-17
4.8 Display of Device Manager	4-17
CHAPTER 5 SPECIFICATIONS	5-1
5.1 Equipment Specifications	5-1
5.2 Memory Space	5-7
5.3 I/O Space	5-8
5.4 Interrupts list	5-9
5.5 Serial Port Settings	5-10
5.6 BIOS Setup	5-11
5.7 Boot Menu	5-17
5.8 Hardware System Clock	5-18
5.9 Interface Specifications	5-19
5.9.1 Connector specifications	5-19
5.9.2 External control specifications	5-24
5.9.3 External interface cable length specifications	5-28
CHAPTER 6 CHECKUP AND MAINTENANCE	6-1
6.1 Daily Checkup	6-1
6.2 Periodic Checkup	6-4
6.3 Installing and Removing Components	6-5
6.3.1 Types and locations of installed components	6-5
6.3.2 Before installing or removing components	6-6
6.3.3 Installing and removing the cover of the equipment	6-7
6.3.4 Installing and removing an extension board	6-8
6.3.5 Installing and removing a main memory	6-12
6.3.6 Installing and removing an HDD	6-15
6.3.7 Installing and removing a DVD drive	6-18
6.3.8 Attaching and removing rack-mounting metal fittings (option)	6-20
6.3.9 Attaching and removing rubber feet	6-22
6.3.10 Replacing a dust filter	6-24
6.4 Installing and removing a lithium battery	6-25
6.5 Enabling the Remote Power On Function	6-27

CHAPTER 7	RESTORING THE FACTORY-SHIPED CONDITION USING A RECOVERY DVD	7-1
7.1	Overview of Restoration Procedure	7-1
7.2	Preparation	7-2
7.3	Restoring the System Drive Back to the Factory-Shipped Condition	7-3
7.3.1	Procedure for restoring the system drive back to the factory-shipped condition	7-3
7.3.2	Errors generated during a restoration process and their corrective actions	7-11
CHAPTER 8	MAINTENANCE OPERATIONS	8-1
8.1	Overview	8-1
8.2	Collecting a Memory Dump	8-6
8.2.1	Memory Dump Confirmation Messages	8-8
8.2.2	Configuring the settings related to a memory dump	8-9
8.3	Startup Suppression on Serious Failure Detection	8-11
8.4	Maintenance Operation Commands	8-12
8.4.1	Log information collection command (logsave)	8-13
8.4.2	Memory dump file copy command (mdump)	8-15
8.4.3	Disk area allocation command for saving a memory dump (createdmp)	8-17
8.4.4	RAS information display command (getrasinfo)	8-19
CHAPTER 9	TROUBLESHOOTING	9-1
9.1	List of Problems	9-1
9.1.1	Problems that occur before the OS startup	9-1
9.1.2	Problems that occur after the OS startup	9-2
9.2	Countermeasures	9-3
9.2.1	Problems that occur before the OS startup	9-3
9.2.2	Problems that occur after the OS startup	9-7
9.3	STOP Error Codes	9-20
9.4	Event Log	9-22
9.5	Checking the System Load by Using Performance Monitor	9-27
9.6	Digital LED for Status indication	9-31
9.6.1	POST messages	9-31
9.6.2	Displaying a hardware status code	9-33

CHAPTER 10	RAID1	10-1
10.1	What is RAID1	10-1
10.2	Setup	10-3
10.2.1	Overview of setup	10-3
10.2.2	Newly setting up RAID1	10-3
10.3	Checking the Status of the RAID1	10-4
10.3.1	Checking by the Status Lamps	10-4
10.3.2	Checking by the Hardware Status Window	10-5
10.4	Recovery from failure	10-6
10.4.1	Detecting a failure	10-6
10.4.2	Recovery from a failure in one HDD	10-7
10.4.3	Recovery from Failure in Both HDDs	10-12
10.5	Preventive Maintenance	10-15
10.5.1	Creating a Backup HDD	10-15
10.5.2	Recovery Using a Backup HDD	10-16
10.5.3	Performing Periodical HDD Replacement	10-17
APPENDIX	HANDLING REPLACEABLE COMPONENTS	A-1

FIGURES

Figure 1-1	Name of Each Part (Front View)	1-5
Figure 1-2	Name of Each Part (Rear View)	1-6
Figure 1-3	Physical Configuration Inside Equipment	1-7
Figure 1-4	Operation and Service Clearance (Top View)	1-15
Figure 1-5	Installation Clearance	1-15
Figure 1-6	Exterior View (Horizontal Installation on the Desktop)	1-16
Figure 1-7	Exterior View (Rack Mount)	1-16
Figure 1-8	Exterior View (Vertical Installation)	1-18
Figure 1-9	Hardware Connection	1-20
Figure 2-1	DVD Drive (Front View)	2-6
Figure 6-1	Types and Locations of Installed Components	6-5
Figure 6-2	Removing the Cover of the Equipment	6-7
Figure 6-3	Installing an extension board	6-11
Figure 6-4	Removing the SATA cables	6-13
Figure 6-5	Installing a main memory	6-14
Figure 6-6	Opening the front cover	6-16
Figure 6-7	Removing an HDD	6-16
Figure 6-8	Removing a DVD cover	6-18
Figure 6-9	Removing the screw fixing the DVD drive	6-19
Figure 6-10	Removing the DVD drive	6-19
Figure 6-11	Attaching Rack-Mounting Metal Fittings	6-21
Figure 6-12	Removing a Rubber Foot	6-22
Figure 6-13	Removing cover screws	6-23
Figure 6-14	Replacing a dust filter	6-24
Figure 6-15	Removing a lithium battery	6-26
Figure 6-16	Removing a Jumper Socket	6-28
Figure 10-1	HDD status lamp	10-4

TABLES

Table 1-1	Function of Each Part	1-8
Table 1-2	Environment	1-13
Table 1-3	Dimension, Service Clearance, and Installation Clearance	1-15
Table 1-4	Power Cord and Plug Identification	1-23
Table 2-1	Specification of the LAN setting	2-10
Table 3-1	List of Culture names (Windows® 10)	3-18
Table 3-2	List of Culture names (Internet Explorer 11)	3-25
Table 4-1	Error / Warning Eventlog (During the OS setup)	4-1
Table 4-2	Error / Warning Eventlog (While Windows® 10 and Windows Server® 2016 are running) (1/2)	4-2
Table 4-3	Error / Warning Eventlog (While Windows® 10 and Windows Server® 2016 are running) (2/2)	4-3
Table 4-4	Error / Warning Eventlog (While Windows® 7 is running)(1/2)	4-4
Table 4-5	Error / Warning Eventlog (While Windows® 7 is running)(2/2)	4-5
Table 5-1	Common specifications list	5-1
Table 5-2	Individual specifications list	5-3
Table 5-3	OS type list	5-4
Table 5-4	Accessories list	5-4
Table 5-5	Option Specifications	5-4
Table 5-6	Supported resolutions list	5-5
Table 5-7	Main memory constitution list	5-5
Table 5-8	Optional LAN adapter specifications list	5-5
Table 5-9	Maximum current specifications	5-6
Table 5-10	Maximum current specifications by function	5-6
Table 5-11	I/O Space list	5-8
Table 5-12	Interrupts list	5-9
Table 5-13	Interrupts list (IRQ assignment when the APIC is disabled)	5-10
Table 5-14	Serial port default settings	5-10
Table 5-15	BIOS Setup menu operation key	5-11
Table 5-16	BIOS Setup menu list	5-12
Table 5-17	Boot menu operation key	5-17
Table 5-18	Boot menu list	5-17
Table 5-19	Hardware System Clock Specification	5-18
Table 5-20	External control I/O port specifications	5-24
Table 5-21	List of external control I/O signals	5-25
Table 5-22	External interface cable length specifications	5-28
Table 6-1	Periodic Checkup	6-4
Table 6-2	Extension boards list	6-9
Table 6-3	Main memory combination list	6-14
Table 6-4	Remote Power On setting	6-27
Table 7-1	List of errors of the recovery operation	7-11
Table 8-1	RAS features overview	8-1
Table 8-2	Error That Trigger a Memory Dump	8-6
Table 8-3	Maintenance Operation Commands	8-12

Table 8-4	Information Saved by logsave	8-13
Table 8-5	Error Messages of the logsave Command	8-14
Table 8-6	Error Messages of the mdump Command	8-16
Table 8-7	Error Messages of the createdmp Command	8-18
Table 8-8	Information Displayed by the getrasinfo Command	8-19
Table 8-9	Error Messages of the getrasinfo Command	8-28
Table 9-1	STOP Error Codes	9-20
Table 9-2	Action list for STOP Error Code 0x80	9-21
Table 9-3	Event Log Entries Unique to the Equipment	9-23
Table 9-4	Performance Counters Related to the Performance of the Equipment	9-29
Table 9-5	POST Codes and Stop Factor/Action	9-31
Table 9-6	Hardware Status Code and Cause/Action	9-33
Table 10-1	Action list of when the RAID detected failure	10-6

CHAPTER 1 GETTING STARTED

1.1 Scope

This manual is intended for operators of the HITACHI INDUSTRIAL COMPUTER HF-W7500 MODEL 50 and contains information about the operation and maintenance of various devices necessary for their routine use.

After you unpack, go through the “delivered items list” to confirm all the items have been delivered and no items are missing or damaged. If there are missing or damaged items, contact our sales representative.

For information about RAS features, refer to the following manuals.

- *HF-W7500 MODEL 50 RAS FEATURES MANUAL* (manual number WIN-63-0096)

1.2 Installing an Extension Board

You can install an extension board supplied by the user in this equipment.

For information about the installation procedure and the limitations of an extension board, see “6.3.4 Installing and removing an extension board”.

1.3 Role of an Operator

In order to use this equipment in good working order for a long period of time, an operator must take care of the following items.

(1) Setting up consumable items

- (a) When you set up a consumable item (such as an HDD, or a dust filter), follow the device operating procedure shown in the respective chapters.

(2) Consideration for the characteristics of the equipment

- (a) See “PRECAUTIONS 1. PRECAUTIONS ABOUT THE EQUIPMENT” and take necessary actions considering the characteristics of the equipment.
- (b) The instructions described in this manual are the basics of the procedures you need to follow when you use the equipment. Make sure you follow these instructions.
- (c) For information about how to use the equipment, how to clean the equipment, and so on, see the respective chapters.

(3) Keep this equipment in good condition

When you use this equipment, an operator must take care of the following items.

(a) Backing up files

See “PRECAUTIONS 4. HARD DISKS DRIVES (HDDs) (2) Backing Up Files”.

(b) Power cord and shutting down the power

See “PRECAUTIONS 1. PRECAUTIONS ABOUT THE EQUIPMENT
(4) POWER SUPPLY”.

(4) Maintenance of this equipment

(a) For information about maintenance, see “6.1 Daily Checkup” and “6.2 Periodic Checkup”.

1.4 Work Flow

The following provides the work flow required until the equipment is turned on.

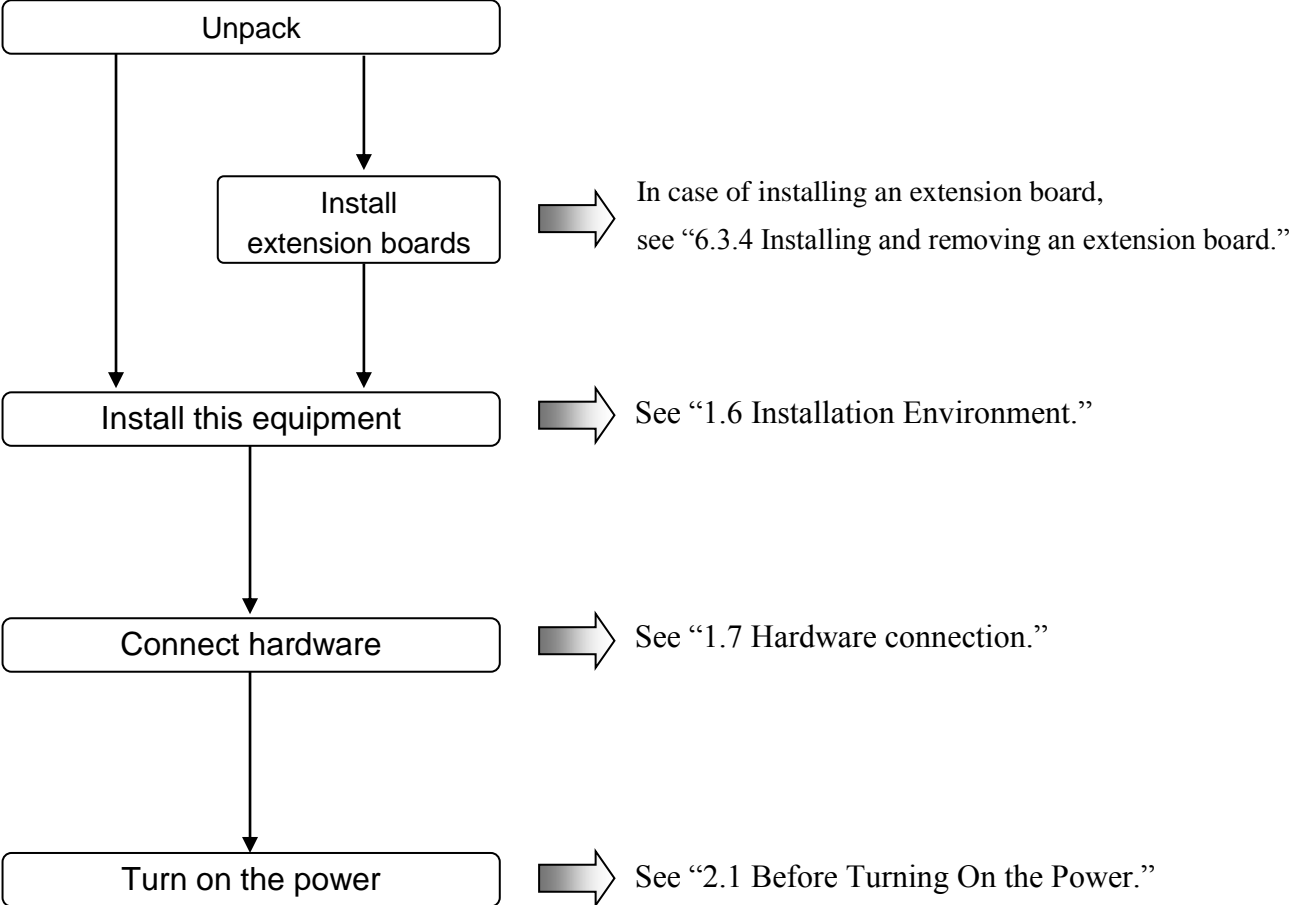

1.5 Name and Function of Each Part



WARNING

Warning about the power supply unit (hazardous voltage)

Do not remove, disassemble, or modify the power supply unit. If you do, serious personal injury or death may result due to an electric shock.



CAUTION

Cautions about the fans (rotating objects)

Only maintenance personnel are allowed to remove a fan. If you remove a fan yourself, your hand or objects may be caught by the rotating part of the operating fan and personal injury may result.

NOTICE

- Never hot-swap HDDs because that may cause failure of the equipment and HDDs. Before you replace an HDD, make sure you shut down the OS, turn off the main power to the equipment, and wait for at least one minute.
- When using a USB port, check the orientation of the USB connector, and then insert the connector slowly. Otherwise, the USB port may be damaged.
- Do not remove or insert a USB device during online operation (system operation) because that may affect currently running applications.
- If you insert or access a CD or DVD, the system load may increase and running applications may be affected. Do not insert or access an optical disc during online operation (system operation).

● Display and User Input Sections

(1) Front view

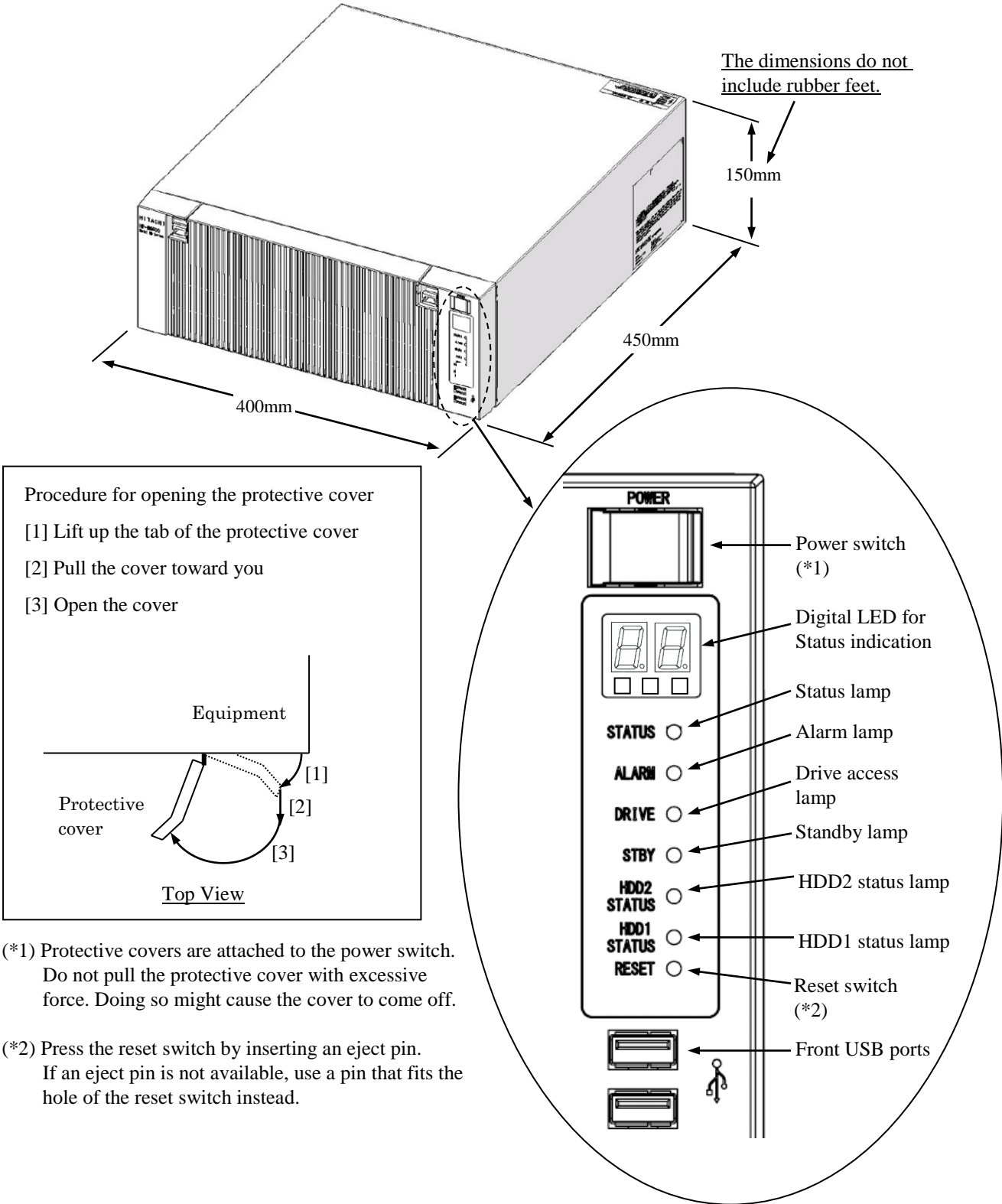

Figure 1-1 Name of Each Part (Front View)

(2) Rear view

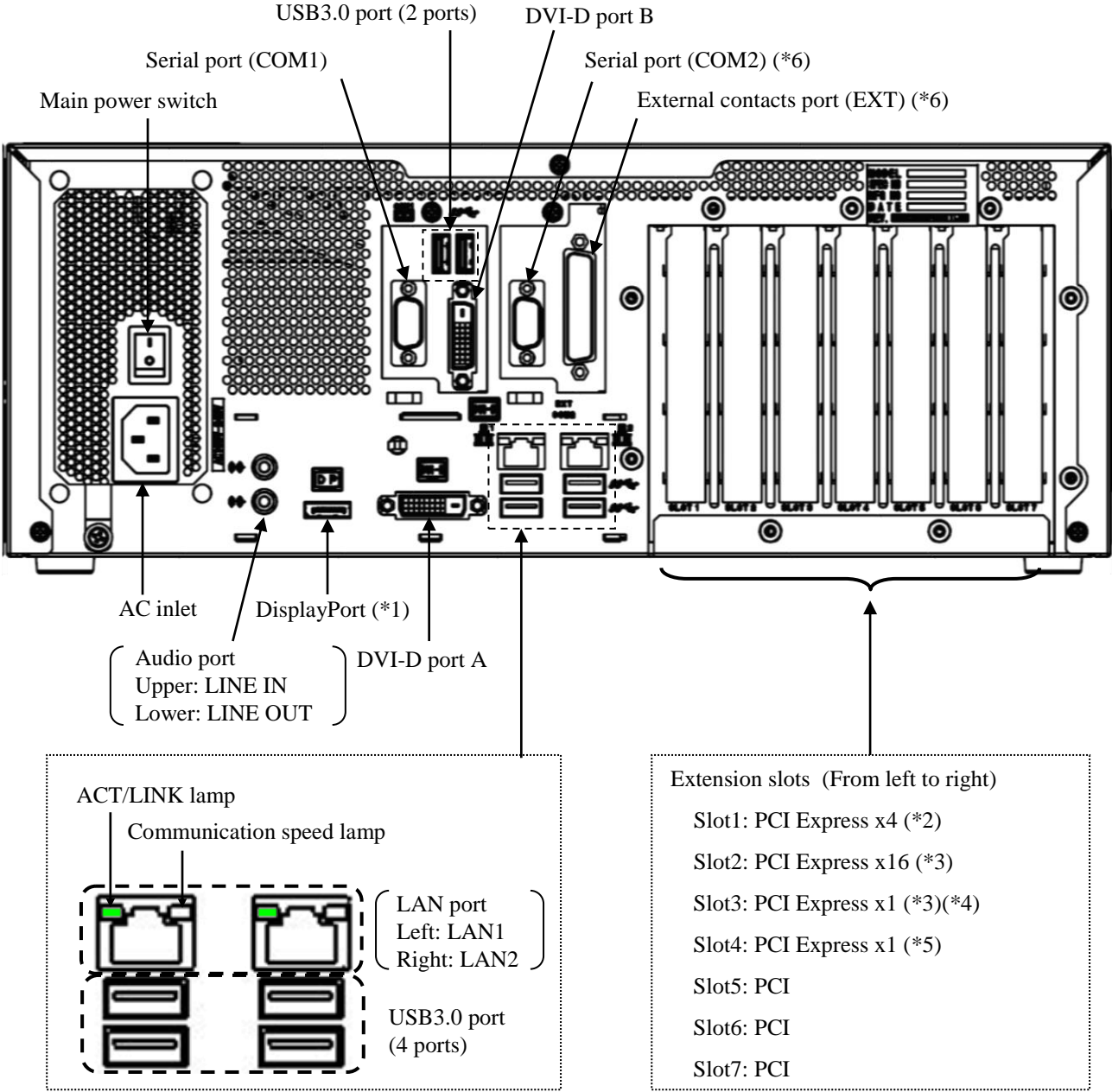

Figure 1-2 Name of Each Part (Rear View)

(*1) If a display unit connected with DisplayPort is turned off, the display cannot be detected.

(*2) This slot can not be used because the RAID board is installed.

(*3) By the BIOS setup, you can change the number of the available lanes as follows.

See "5.6 BIOS setup" if you want to change the BIOS setup.

BIOS settings	Slot2	Slot3
Setting 1 (Default)	PCI Express x16	PCI Express x1
Setting 2	PCI Express x8	PCI Express x8

(*4) PCI Express x16 connectors is used but the internal connection is equivalent to PCI Express x1 or PCI Express x8.

(*5) PCI Express x4 connectors is used but the internal connection is equivalent to PCI Express x1.

(*6) Serial port (COM2) and External contact port (EXT) are optional ports.

(3) Physical configuration inside the equipment

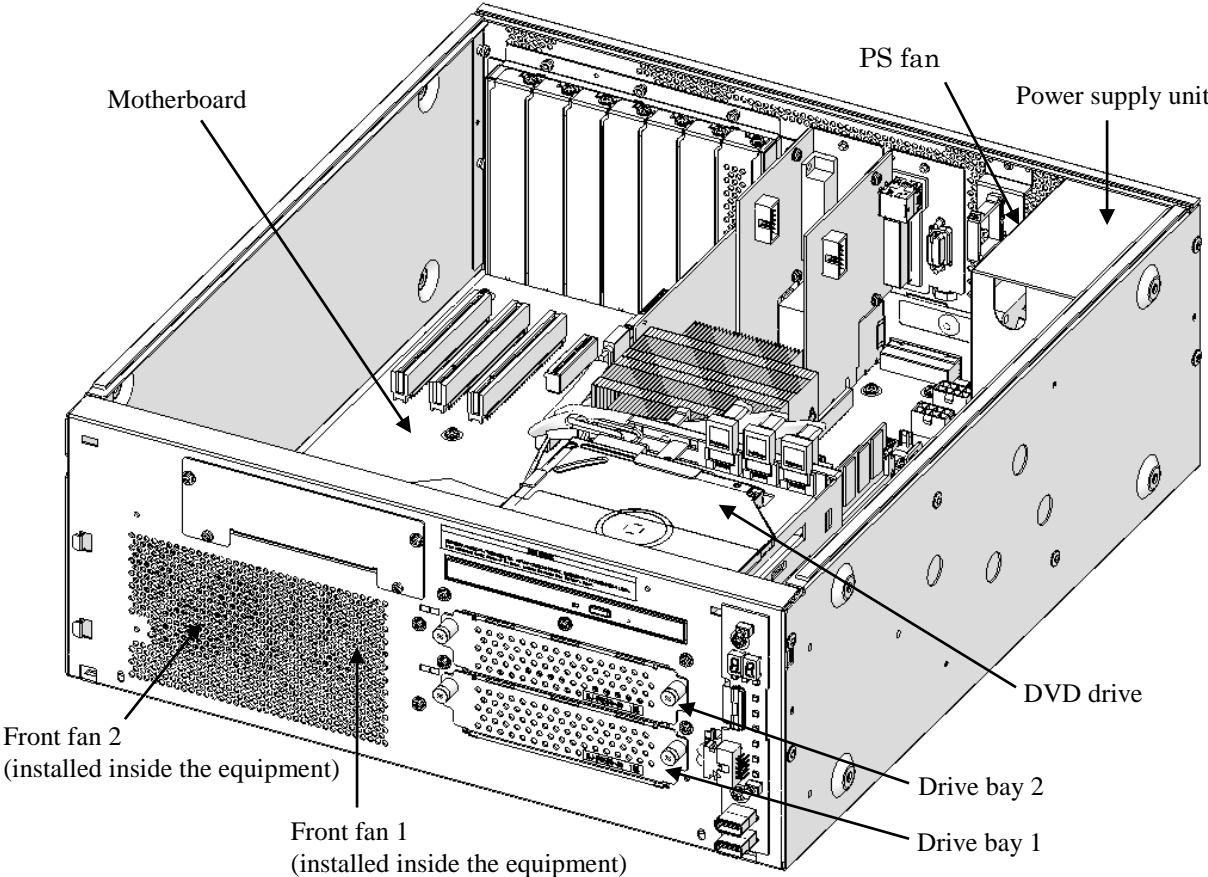

Figure 1-3 Physical Configuration Inside Equipment

Table 1-1 Function of Each Part (1/5)

Name	Function										
Power switch (POWER)	When you press this switch, the power is turned on. When you press the switch for four seconds or more, the power is turned off and the system goes into standby mode (for emergencies only).										
Reset switch (RESET)	Use this switch to perform a hardware reset (restarting the equipment). If you press the switch while the OS is running, a memory dump is performed. If you press the switch again after the memory dump is performed, a hardware reset is carried out.										
Status lamp (STATUS)	<table border="1"> <thead> <tr> <th>Lamp</th> <th>Status</th> </tr> </thead> <tbody> <tr> <td>Lit in green</td> <td>The equipment is in operation (RUN status)</td> </tr> <tr> <td>Lit in red</td> <td>The equipment is not in operation (STOP status) <ul style="list-style-type: none"> • The equipment is in the middle of startup. • After the shutdown starts or during error stop. • The equipment has stopped abnormally due to an error • RAS software is not installed. </td> </tr> <tr> <td>Off</td> <td>The main power is off / The system is in standby mode.</td> </tr> </tbody> </table>	Lamp	Status	Lit in green	The equipment is in operation (RUN status)	Lit in red	The equipment is not in operation (STOP status) <ul style="list-style-type: none"> • The equipment is in the middle of startup. • After the shutdown starts or during error stop. • The equipment has stopped abnormally due to an error • RAS software is not installed. 	Off	The main power is off / The system is in standby mode.		
Lamp	Status										
Lit in green	The equipment is in operation (RUN status)										
Lit in red	The equipment is not in operation (STOP status) <ul style="list-style-type: none"> • The equipment is in the middle of startup. • After the shutdown starts or during error stop. • The equipment has stopped abnormally due to an error • RAS software is not installed. 										
Off	The main power is off / The system is in standby mode.										
Alarm lamp (ALARM)	This lamp is lit in red if one of the following abnormalities is detected. <ul style="list-style-type: none"> • A fan inside the equipment stops. • Abnormal temperature inside the equipment. • Failure in one of the mirrored disks. 										
Drive access lamp (DRIVE)	This lamp is lit in green while an HDD or DVD drive is being accessed.										
Standby lamp (STBY)	<table border="1"> <thead> <tr> <th>Lamp</th> <th>Status</th> </tr> </thead> <tbody> <tr> <td>Lit in orange</td> <td>The equipment is in standby mode. (Only the auxiliary power is on.)</td> </tr> <tr> <td>Off</td> <td>The power is shut down or the equipment is in operation.</td> </tr> </tbody> </table>	Lamp	Status	Lit in orange	The equipment is in standby mode. (Only the auxiliary power is on.)	Off	The power is shut down or the equipment is in operation.				
Lamp	Status										
Lit in orange	The equipment is in standby mode. (Only the auxiliary power is on.)										
Off	The power is shut down or the equipment is in operation.										
HDD status lamp (HDD1 STATUS : For drive bay 1 HDD2 STATUS : For drive bay 2)	<table border="1"> <thead> <tr> <th>Lamp</th> <th>Status</th> </tr> </thead> <tbody> <tr> <td>Off</td> <td>One HDD are working properly.</td> </tr> <tr> <td>Lit in red</td> <td>One HDD has an error. (The power of the HDD with an error is Off.)</td> </tr> <tr> <td>Flashed in red (Either one)</td> <td>Rebuild (copy) is ongoing. Only the lamp of the copy destination HDD flashes.</td> </tr> <tr> <td>Flashed in red (Both)</td> <td>Both HDDs have errors.</td> </tr> </tbody> </table>	Lamp	Status	Off	One HDD are working properly.	Lit in red	One HDD has an error. (The power of the HDD with an error is Off.)	Flashed in red (Either one)	Rebuild (copy) is ongoing. Only the lamp of the copy destination HDD flashes.	Flashed in red (Both)	Both HDDs have errors.
Lamp	Status										
Off	One HDD are working properly.										
Lit in red	One HDD has an error. (The power of the HDD with an error is Off.)										
Flashed in red (Either one)	Rebuild (copy) is ongoing. Only the lamp of the copy destination HDD flashes.										
Flashed in red (Both)	Both HDDs have errors.										

Table 1-1 Function of Each Part (2/5)

Name	Function
AC inlet	Used for connecting a power cord.
Power supply	A power supply module with a wide-range input voltage (100 to 240 VAC).
Main power switch	If you press the switch to the 1 position, the power is supplied. If you press the switch to the 0 position, the power is shut down.
Audio port (LINE IN)	An audio line input.
Audio port (LINE OUT)	An audio line output.
Serial port (COM1) (9 pins: RS-232C)	Connects a device such as a modem that uses a serial interface. (See “5.9.1 Connector specifications”.)
Serial port (COM2) (9 pins: RS-232C) (optional)	Connects a device such as a modem that uses a serial interface. (See “5.9.1 Connector specifications”.)
RAS external contact port (25 pins: EXT) (optional)	A connector for connecting external contacts. (See “5.9.1 Connector specifications”.)
DVI-D port (Port A)	Connects the cable from the digital interface of a display. (See “5.9.1 Connector specifications”.)
DVI-D port (Port B)	Connects the cable from the digital interface of a display. (See “5.9.1 Connector specifications”.)
DisplayPort	Connects the cable from the digital interface of a display. (See “5.9.1 Connector specifications”.)
PCI Express bus slot (Slot 1 - Slot4)	Used as a slot to insert a PCI Express board. But the Slot1 can not be used because the RAID board is installed.
PCI bus slot (Slot 5 - Slot 7)	Used as a slot to insert a PCI board.
USB port (USB 3.0)	Used to connect a device that uses a USB interface.
USB port (USB 2.0)	Used to connect a device that uses a USB interface.

Table 1-1 Function of Each Part (3/5)

Name	Function																				
<p>LAN port (1000BASE-T/100BASE-TX/ 10BASE-T)</p>	<p>You can connect a LAN cable to a LAN port. (See “5.9.1 Connector specification”.)</p> <ul style="list-style-type: none"> ● Onboard LAN <div data-bbox="657 488 1390 730" style="text-align: center;"> <p>The diagram shows a rectangular panel with two small square lamps. An arrow points from the label 'Communication speed lamp' to the lamp on the right. Another arrow points from the label 'ACT/LINK lamp' to the lamp on the left.</p> </div> <table border="1" data-bbox="555 775 1417 1317" style="width: 100%; border-collapse: collapse;"> <thead> <tr> <th colspan="2" style="text-align: center;">ACT/LINK lamp</th> </tr> <tr> <th style="width: 20%;">Lamp</th> <th>Status</th> </tr> </thead> <tbody> <tr> <td>Lit in green</td> <td>A link is established. Both the equipment and the remote device are powered up and the connection over the twisted-pair Ethernet cable is stable.</td> </tr> <tr> <td>Off</td> <td>No link is established. <ul style="list-style-type: none"> • The equipment is not physically connected to the network. • The switching hub is not powered up. • The connection over the twisted-pair Ethernet cable is not stable. • The driver settings have some errors. </td> </tr> <tr> <td>Blinking in green</td> <td>Network data is being transmitted or received. The blink interval changes depending on the traffic on the network.</td> </tr> </tbody> </table> <table border="1" data-bbox="555 1346 1417 1603" style="width: 100%; border-collapse: collapse;"> <thead> <tr> <th colspan="2" style="text-align: center;">Communication speed lamp</th> </tr> <tr> <th style="width: 20%;">Lamp</th> <th>Status</th> </tr> </thead> <tbody> <tr> <td>Lit in orange</td> <td>The link is established at 1000 Mbps.</td> </tr> <tr> <td>Lit in green</td> <td>The link is established at 100 Mbps.</td> </tr> <tr> <td>Off</td> <td>The link is established at 10 Mbps. Or no link is established.</td> </tr> </tbody> </table>	ACT/LINK lamp		Lamp	Status	Lit in green	A link is established. Both the equipment and the remote device are powered up and the connection over the twisted-pair Ethernet cable is stable.	Off	No link is established. <ul style="list-style-type: none"> • The equipment is not physically connected to the network. • The switching hub is not powered up. • The connection over the twisted-pair Ethernet cable is not stable. • The driver settings have some errors. 	Blinking in green	Network data is being transmitted or received. The blink interval changes depending on the traffic on the network.	Communication speed lamp		Lamp	Status	Lit in orange	The link is established at 1000 Mbps.	Lit in green	The link is established at 100 Mbps.	Off	The link is established at 10 Mbps. Or no link is established.
ACT/LINK lamp																					
Lamp	Status																				
Lit in green	A link is established. Both the equipment and the remote device are powered up and the connection over the twisted-pair Ethernet cable is stable.																				
Off	No link is established. <ul style="list-style-type: none"> • The equipment is not physically connected to the network. • The switching hub is not powered up. • The connection over the twisted-pair Ethernet cable is not stable. • The driver settings have some errors. 																				
Blinking in green	Network data is being transmitted or received. The blink interval changes depending on the traffic on the network.																				
Communication speed lamp																					
Lamp	Status																				
Lit in orange	The link is established at 1000 Mbps.																				
Lit in green	The link is established at 100 Mbps.																				
Off	The link is established at 10 Mbps. Or no link is established.																				

Table 1-1 Function of Each Part (4/5)

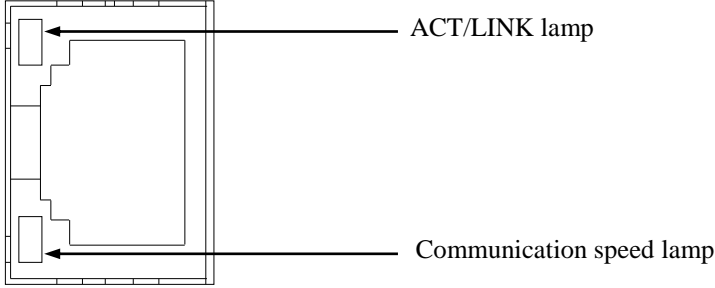
Name	Function																				
LAN port (1000BASE-T/100BASE-TX/ 10BASE-T)	<p data-bbox="544 331 1002 360">● Option LAN adaptor (HJ-F7550-20)</p>  <p data-bbox="1109 409 1294 439">ACT/LINK lamp</p> <p data-bbox="1109 629 1417 658">Communication speed lamp</p> <table border="1" data-bbox="555 725 1417 1267"> <thead> <tr> <th colspan="2" data-bbox="555 725 1417 763">ACT/LINK lamp</th> </tr> <tr> <th data-bbox="555 763 724 801">Lamp</th> <th data-bbox="724 763 1417 801">Status</th> </tr> </thead> <tbody> <tr> <td data-bbox="555 801 724 936">Lit in green</td> <td data-bbox="724 801 1417 936">A link is established. Both the equipment and the remote device are powered up and the connection over the twisted-pair Ethernet cable is stable.</td> </tr> <tr> <td data-bbox="555 936 724 1167">Off</td> <td data-bbox="724 936 1417 1167">No link is established. <ul style="list-style-type: none"> • The equipment is not physically connected to the network. • The switching hub is not powered up. • The connection over the twisted-pair Ethernet cable is not stable. • The driver settings have some errors. </td> </tr> <tr> <td data-bbox="555 1167 724 1267">Blinking in green</td> <td data-bbox="724 1167 1417 1267">Network data is being transmitted or received. The blink interval changes depending on the traffic on the network.</td> </tr> </tbody> </table> <table border="1" data-bbox="555 1301 1417 1554"> <thead> <tr> <th colspan="2" data-bbox="555 1301 1417 1339">Communication speed lamp</th> </tr> <tr> <th data-bbox="555 1339 724 1377">Lamp</th> <th data-bbox="724 1339 1417 1377">Status</th> </tr> </thead> <tbody> <tr> <td data-bbox="555 1377 724 1444">Lit in orange</td> <td data-bbox="724 1377 1417 1444">The link is established at 1000 Mbps.</td> </tr> <tr> <td data-bbox="555 1444 724 1482">Lit in green</td> <td data-bbox="724 1444 1417 1482">The link is established at 100 Mbps.</td> </tr> <tr> <td data-bbox="555 1482 724 1554">Off</td> <td data-bbox="724 1482 1417 1554">The link is established at 10 Mbps. Or no link is established.</td> </tr> </tbody> </table>	ACT/LINK lamp		Lamp	Status	Lit in green	A link is established. Both the equipment and the remote device are powered up and the connection over the twisted-pair Ethernet cable is stable.	Off	No link is established. <ul style="list-style-type: none"> • The equipment is not physically connected to the network. • The switching hub is not powered up. • The connection over the twisted-pair Ethernet cable is not stable. • The driver settings have some errors. 	Blinking in green	Network data is being transmitted or received. The blink interval changes depending on the traffic on the network.	Communication speed lamp		Lamp	Status	Lit in orange	The link is established at 1000 Mbps.	Lit in green	The link is established at 100 Mbps.	Off	The link is established at 10 Mbps. Or no link is established.
ACT/LINK lamp																					
Lamp	Status																				
Lit in green	A link is established. Both the equipment and the remote device are powered up and the connection over the twisted-pair Ethernet cable is stable.																				
Off	No link is established. <ul style="list-style-type: none"> • The equipment is not physically connected to the network. • The switching hub is not powered up. • The connection over the twisted-pair Ethernet cable is not stable. • The driver settings have some errors. 																				
Blinking in green	Network data is being transmitted or received. The blink interval changes depending on the traffic on the network.																				
Communication speed lamp																					
Lamp	Status																				
Lit in orange	The link is established at 1000 Mbps.																				
Lit in green	The link is established at 100 Mbps.																				
Off	The link is established at 10 Mbps. Or no link is established.																				

(Note1) The locations of ACT/LINK lamp and communication speed lamp differ between the optional LAN adaptor and onboard LAN.

(Note2) HJ-F7550-20 has two LAN ports. If you look from back side this equipment on horizontal installation, the A port is upper side and the B port is lower side.

Table 1-1 Function of Each Part (5/5)

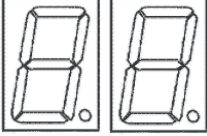
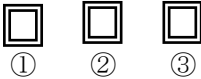
Name	Function
<p data-bbox="156 338 359 398">Digital LED for Status indication</p>   <p data-bbox="204 723 475 748">Status indication LEDs</p>	<p data-bbox="539 338 1422 506">Various states of this equipment are indicated as a two-digit code in hexadecimal and the states of the status indication LEDs. The Digital LED for Status indication and the status indication LEDs may remain lit even after the equipment is shut down or put into standby mode. This condition remains until the power is turned on again.</p> <p data-bbox="539 546 895 680">Status indication LEDs [1] Hardware status (Red) [2] Application status (Green) [3] BIOS status (Orange)</p> <p data-bbox="539 719 1422 808">(For information about how to display arbitrary status data on the Digital LED for Status indication from a user application, refer to the “<i>HF-W7500 Model 50 RAS FEATURES MANUAL</i>”.)</p>

< NOTE >

- For information about the precautions for USB devices, see “PRECAUTIONS 6. USB DEVICES”.

1.6 Installation Environment

1.6.1 Environment



CAUTION

If you keep at high temperature this equipment, do not touch bare hands. Otherwise you may result burns.

When this equipment is used, it must be used in the following environment.

Table 1-2 Environment

Item	Requirement
Ambient temperature (Operation)	5 to 40°C(*1)
Ambient temperature (Storage)	-10 to 60°C
Temperature gradient	±10 K/h or less
Humidity	20 to 80%RH (non-condensing)
Humidity gradient	± 10% RH/h or less
Dust (*2)	No heavy dust (0.3 mg/m ³ or less (JEITA IT-1004A classB))
Corrosive gas	None JEITA IT-1004A class A (Temperature 25°C, Humidity 50% RH)(*3)
Vibration resistance	5.9 m/s ² (10 Hz, 5 s, except the DVD drive)
Shock resistance	Operation: 19.6 m/s ² (while not powered on: 98 m/s ²)
Power voltage	100 to 240 VAC ± 10%
Power frequency	50/60 Hz ± 3 Hz
Power supply noise	2.0 kV (fast transient / burst wave)
Electrostatic noise contact discharge	4 kV (Air: 8 kV)
Insulation resistance	500 VDC, 20 MΩ
Dielectric strength	1.5 kVAC, one minute
Transient power fault	20 ms or less
Altitude	Less than 1000 m

(*1) If you change "Hyper Threading" setting to "Enabled" by the BIOS setup menu, the upper limit of the Ambient temperature (Operation) becomes 35 degrees Celsius.

(*2) This equipment cannot be used in the environment where conductive dust or the like is floating.

(*3) JEITA : Japan Electronics and Information Technology Industries Association

< NOTE >

- For information about the precautions for the environment, see "PRECAUTIONS 1. PRECAUTIONS ABOUT THE EQUIPMENT (5) INSTALLATION ENVIRONMENT".

1.6.2 Installation



WARNING

- The power cord that comes with the equipment is rated at the input voltage of 125 VAC. When using this equipment at over 125 VAC, prepare the power cord fitting input voltage and inspect the safeness of this equipment enough.
- When you connect the plug of the power cord to an outlet, make sure you use an outlet with a ground terminal (ground pole) that is properly grounded. In addition, you must install and use an earth leakage circuit breaker.
If you do not take these measures, that may result in a fire or an electric shock.
- Do not use a two-prong plug without a ground pole because that may result in an electric shock or failure of the equipment.



CAUTION

When you install the equipment vertically, be sure to secure it with a vertical installation bracket. If you do not secure it with the installation bracket, the equipment may fall and personal injury may result.

NOTICE

- Before you move this equipment, make sure you shut down the OS, disconnect the plug of the power cord from the outlet, and wait for at least one minute.
If you do not, the HDDs and other devices may fail.
- When you transport or carry the equipment, pack it in the dedicated container (container and packing materials used when the equipment was delivered). If you use other container or packing materials, that may damage the equipment.
- Do not use damaged or broken dedicated container when you transport or carry the equipment. If you do, that may damage the equipment.

< NOTE >

- For information about the precautions for concerning installation requirements, see “PRECAUTIONS 1. PRECAUTIONS ABOUT THE EQUIPMENT (5) INSTALLATION ENVIRONMENT”.

Table 1-3 Dimension, Service Clearance, and Installation Clearance

Dimension (mm)			Operation and service clearance (mm)				Installation clearance (mm)			
Height	Width	Depth	Front	Rear	Left	Right	Front	Rear	Left	Right
150	400	450	500	600	200	200	50	100	10	10

- When you operate the equipment or do maintenance work, provide sufficient clearance as shown in Figure 1-4.
- The equipment is air-cooled by fans. The intake holes are on the front and the exhaust holes are on the rear. Make sure the air flow is not blocked. Especially, leave sufficient clearance in the front (50 mm) and in the rear (100mm). (This includes clearance required for routing cable connectors for the rear side.)

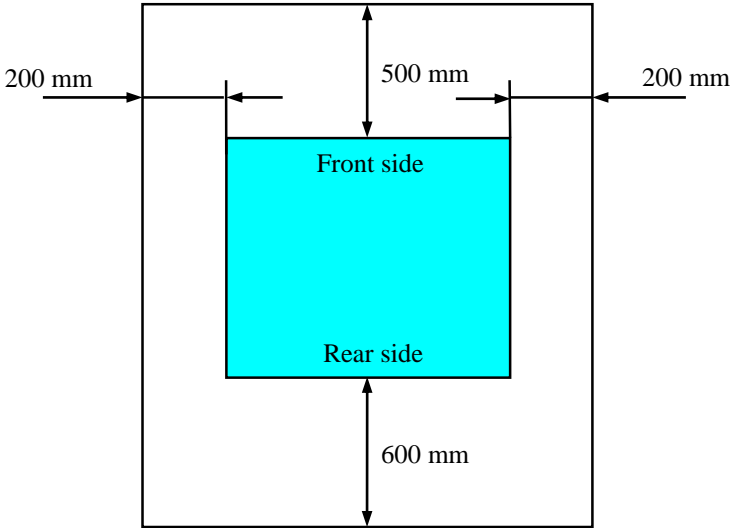
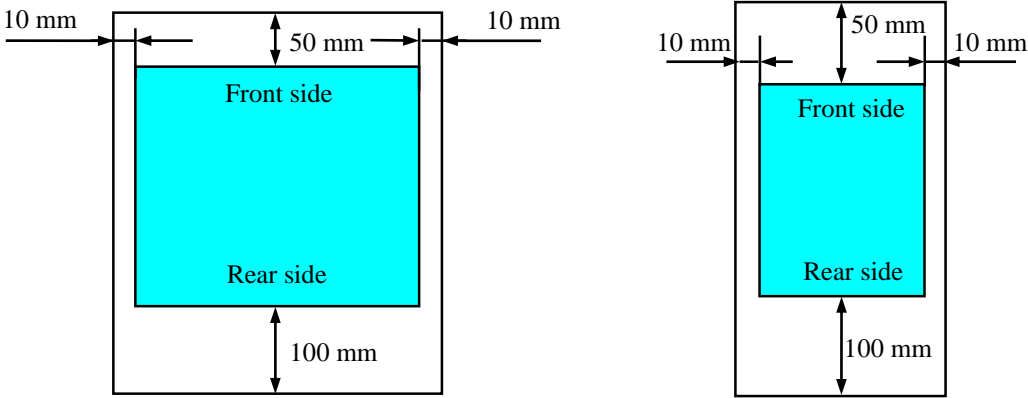

Figure 1-4 Operation and Service Clearance (Top View)



Horizontal Installation (Top View)

Vertical Installation (Top View)

Figure 1-5 Installation Clearance

(a) Horizontal Installation

Place a non-slip mat between the equipment and the desktop to secure the equipment.

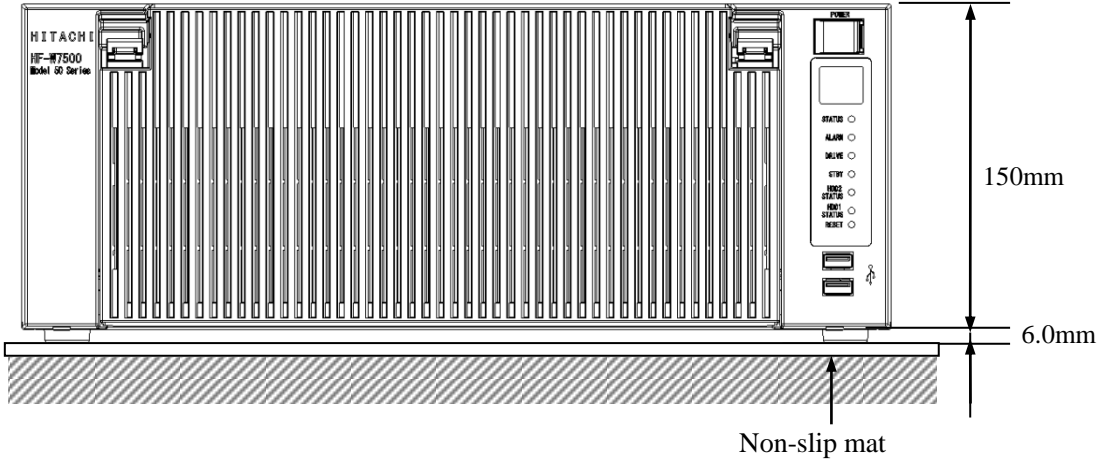
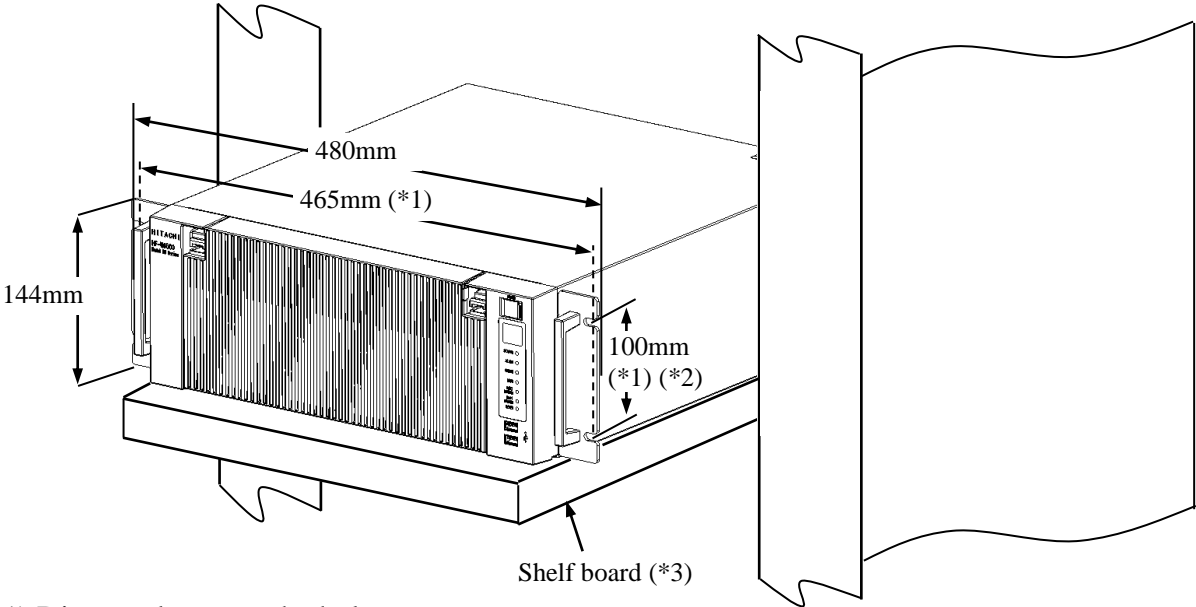

Figure 1-6 Exterior View (Horizontal Installation on the Desktop)

(b) Rack mount

- For information about how to attach and remove rack-mounting metal fittings, see “6.3.8 Attaching and removing rack-mounting metal fittings (option)”.
- For information about how to remove rubber feet, see “6.3.9 Attaching and removing rubber feet”.



- (*1) Distance between the hole centers.
- (*2) This size is based on JIS of the rack-mounting metal fitting. For EIA, the size is 101.6mm.
- (*3) When you mount the equipment on a rack mount, we recommend that you use a combination of rack-mounting metal fittings, a shelf board for a rack mount, and slide rails for safety reasons.

Figure 1-7 Exterior View (Rack Mount)

- When mounting the equipment inside a rack, fully address the concerns below. For the rack mounting metal fittings, see Subsection 1.6.2 Installation (b), “Rack mount.”
- Elevated Operating Ambient: If installed in a closed or multi-unit rack assembly, the operating ambient temperature of the rack environment may be greater than room ambient. Therefore, consideration must be given to installing the equipment in an environment compatible with the maximum ambient temperature specified in Subsection 1.6.1 Environment.
- Reduced Air Flow: Installation of the equipment in a rack must be such that the amount of air flow required for safe operation of the equipment is not compromised.
- Mechanical Loading: Mounting of the equipment in the rack must be such that a hazardous condition is not achieved due to uneven mechanical loading.
- Circuit Overloading: Consideration must be given to the connection of the equipment to the supply circuit and the effect that overloading of the circuits might have on overcurrent protection and supply wiring. Appropriate consideration of equipment nameplate ratings must be used when addressing this concern.
- Reliable Earthing: Reliable earthing of rack-mounted equipment must be maintained. Particular attention must be given to supply connections other than direct connections to the branch circuit (e.g., use of power strips).

(c) Vertical Installation

- When you install the equipment vertically, the status display lamps must come at the upper side and make sure the equipment is placed so it does not fall.
- When you mount the equipment vertically, prepare a mounting metal fitting as shown in the figure below and use it to secure the equipment.
- The mounting metal fitting for vertical installation must be secured to a mounting chassis or rack with casters using set screws at both the upper and lower positions.
- For information about how to remove rubber feet, see “6.3.9 Attaching and removing rubber feet”.

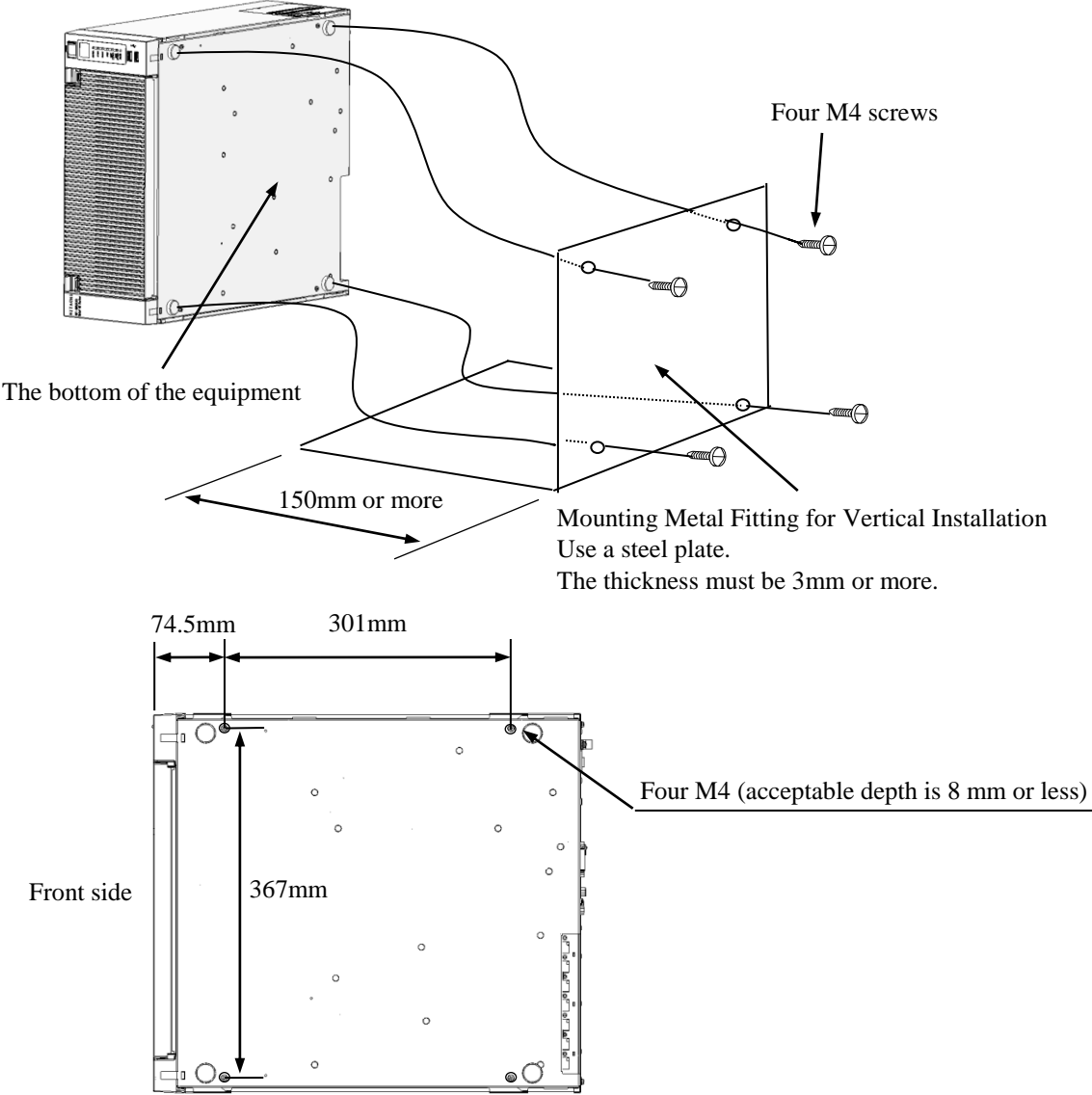



Figure 1-8 Exterior View (Vertical Installation)

 CAUTION
When you install the equipment on the vertical installation bracket, do not use the cover screws to secure the equipment. If you use the cover screws, the equipment may fall and personal injury may result.

1.7 Hardware connection

NOTICE

- Do not route the interface cables, etc. (including cables for other devices such as a PC) near the power cord. If you do, a failure or malfunction of the equipment may result.
- Do not connect or disconnect an interface cable while the power for this equipment or for the remote device is on. If you do, failure of the equipment may result due to a short circuit between the power supply and the ground. When an interface cable comes off while the power for the equipment is on, shut down the OS and disconnect the power cord from the outlet. Disconnecting the power cord from the outlet without shutting down the OS might destroy the internal files.
- When you connect a cable for external contacts, make sure you connect the cable to a connector for the external contacts (EXT). It is possible that a voltage as high as 40 VDC can be applied to the cable through a relay load. If you connect the cable to the wrong connector, that may cause failure of the equipment.

Before you connect hardware, carefully read SAFETY INSTRUCTIONS in this document and fully understand the contents.

Connect hardware based on the connection example shown in the figure below.

Connect the display, keyboard, and mouse to this equipment and then insert the plug of the power cord into an outlet.

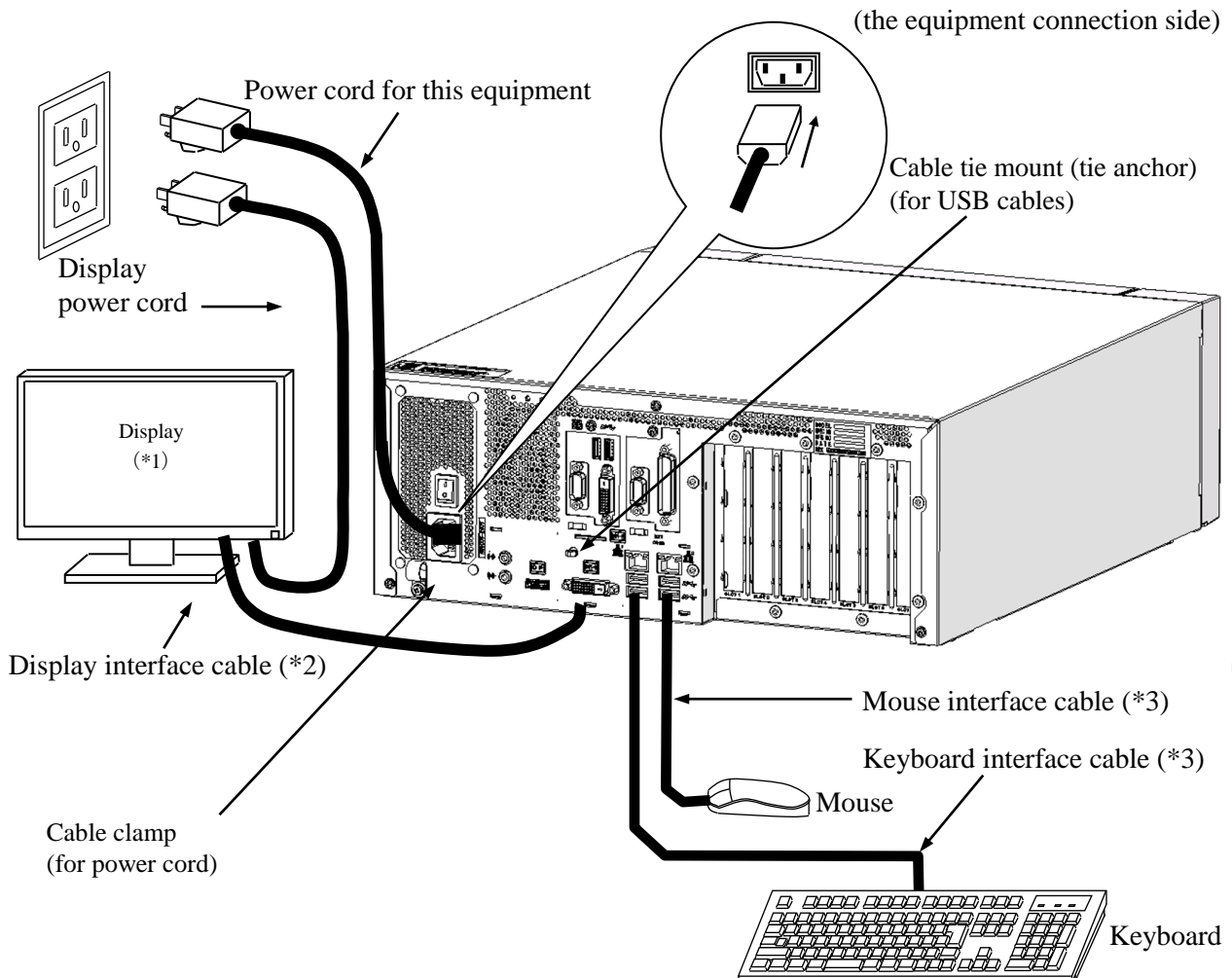

Figure 1-9 Hardware Connection

(*1) For information about the naming of the user input module and how to operate and adjust the device, refer to the user's manual that comes with the device.

(*2) For information about the length of each connection cable, see "5.8.3 External interface cable length". The mouse and keyboard connection cables must be directly connected to this equipment. Do not use extension cables for them. If you use extension cables, the mouse or keyboard may not work properly.

(*3) When you connect USB devices to the USB connectors, pay attention to the orientation of the connector. In addition, in the USB port, a USB cable may fall out from the connector by the unexpected contact because there is not the locking mechanism of the connector in a standard. When you install this equipment, fix USB cables if it is necessary.

(Note) In order to conformity the EMC standards (VCCI, FCC, CE), use shielded cables for the interface cables (display interface cable, keyboard interface cable, and mouse interface cable) connected to the equipment.

- Connecting to an outlet

Fully and securely insert the plug of the power cord of this equipment into an outlet with a grounding pole that is properly grounded. (*1)

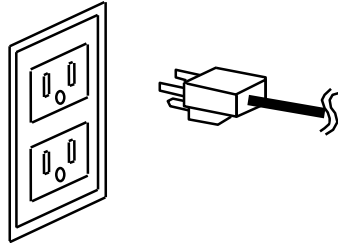

Make sure you use a power cord with a 2-pole plug with a grounding pole.

(*1) If you have no other choice than to use an outlet without a grounding pole that is properly grounded, use 3-pole to 2-pole conversion adapter and connect the green ground line from the adapter to the ground of the outlet. A user must verify the proper functionality of the 3-pole to 2-pole conversion adapter before using it.

< NOTE >

- The power cord that comes with the equipment is rated at the input voltage of 125 VAC. When using this equipment at over 125 VAC, prepare the power cord fitting input voltage.
- If you use a power cord clamp for preventing accidental disconnection, add an extra length to the power cord around the connector when you secure the cord, in order to allow the cord to be disconnected in an emergency. Alternatively, install an emergency circuit breaker at the outlet side.

1.8 Power cord





CAUTION

When procuring an AC power cord, make sure that the cord has proper rating and meets local safety requirements whatever applicable. Otherwise, an electric shock or machine failure may result.

The power cord that comes with the equipment is rated at the input voltage of 125VAC. When using this equipment at over 125VAC, prepare the power cord fitting input voltage and inspect the safeness of this equipment enough. Common power cords are shown in Table 1-3.

- 1 ANSI: American National Standards Institute
- 2 NEMA: National Electrical Manufacture's Association
- 3 IEC: International Electrotechnical Commission
- 4 CEE: International Commission on Rules for the Approval of Electrical Equipment
- 5 BS: British Standard Institution
- 6 AS: Standards Association of Australia
- 7 GB: 国家标准(Guójiā Biāozhǔn)

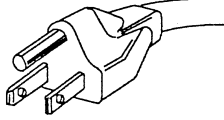
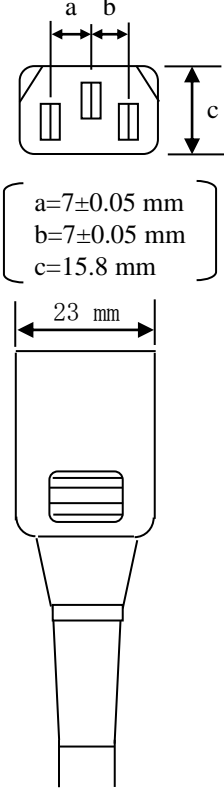
Table 1-4 Power Cord and Plug Identification

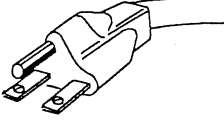
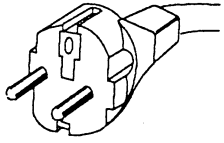
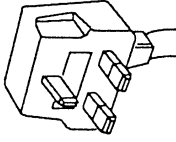
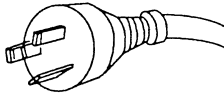
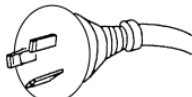
Input rating	Plug configuration	Reference standards	Cord and connector
100V - 120V	 North America	1 ANSI C73.11 2 NEMA 5-15P 3 IEC 83	 <p>Three-wire power cord with a two-pole three-terminal grounding-type connector.</p> <p>电源线请务必使用带接地相的3相插头。</p>
125V	 North America	1 ANSI C73.11 2 NEMA 5-15P 3 IEC C13	
200V - 240V	 North America	1 ANSI C73.11 2 NEMA 6-15P 3 IEC 83	
	 Universal Euro	4 CEE (7) II, IV, VII 3 IEC 83	
	 UK	5 BS 1365 3 IEC 83	
	 Australia	6 AS C112	
220V - 250V	 中华人民共和国	7 GB/T 5023.5 GB 1002, GB 2099.1 GB 17465.1 GB 15934	

< NOTE >

- As an option, this equipment offers a cable clamp to be used for attaching the power cord to the equipment. Use that cable clamp as required.
- If you use a power cord clamp for preventing accidental disconnection, add an extra length to the power cord around the connector when you secure the cord, in order to allow the cord to be disconnected in an emergency. Alternatively, install an emergency circuit breaker at the outlet side.

This Page Intentionally Left Blank

CHAPTER 2 OPERATION

2.1 Before Turning On the Power



WARNING

If any of the air intake and exhaust holes of the equipment is blocked, the temperature inside the equipment may rise and that may cause a fire or failure of the equipment. Make sure sufficient clearance is provided around the equipment when you install. (See “1.6.2 Installation”.)

< NOTE >

When you turn on the power, see the following:

- “PRECAUTIONS 1. PRECAUTIONS ABOUT THE EQUIPMENT
(2) INTERFACE CABLES
- “PRECAUTIONS 1. PRECAUTIONS ABOUT THE EQUIPMENT
(4) POWER SUPPLY”
- “PRECAUTIONS 1. PRECAUTIONS ABOUT THE EQUIPMENT
(5) INSTALLATION ENVIRONMENT”

2.2 Starting the Equipment

Follow the procedure below to start the equipment:

1. Connect the plug of the power cord to the outlet.
2. Turn on the power to the display.
3. Turn on the main power switch on the rear of the equipment. The standby lamp (STBY) will be turned on.
4. Open the protective cover on the right upper part of the front panel and press the power switch. (See “1.5 Name and Function of Each Part”.)
5. When the power is turned on, the standby lamp (STBY) is turned off and the status lamp (STATUS) will light. The status lamp turns “red” when the power is turned on and turns “green” when the OS starts and the equipment is in operation.
6. If you turn on the power for the first time, set up the equipment according to “3.1 Setup Procedure When You Turn On the Power for the First Time”. (You need to follow this procedure only once for the first time when you start the equipment after you purchase the equipment.)

< NOTE >

- When the RAS software is not installed or during the recovery process, the status lamp does not turn green and stays red.

After the above steps are complete, the equipment automatically goes through the startup process until the sign in screen appears.

For information about how to control the power using the LAN, see “2.7 Controlling the Power Using the LAN”.

2.3 Shutting Down the Equipment

When you shut down the equipment, first confirm that no other users are using the equipment and no background programs are running. Then follow the procedure below:

- Stop application programs.
- Shut down the OS.

The specific procedure for stopping an application program differs depending on each application. For more information, see the manual of each application.

<If the OS is Windows® 10 or Windows Server® 2016>

To shut down the OS, click the **Start** button at the left bottom corner of the screen and open the start menu. Then click **Power** and click **Shut down**. After the OS is shut down, the power is automatically turned off and only the auxiliary power supply is on (standby mode). (In this mode, the status lamp (STATUS) is off and the standby lamp (STBY) is on.)

<If the OS is Windows® 7>

To shut down the OS, click the **Start** button at the left bottom corner of the screen and click **Shut down**. After the OS is shut down, the power is automatically turned off and only the auxiliary power supply is on (standby mode). (In this mode, the status lamp (STATUS) is off and the standby lamp (STBY) is on.)

If the normal shutdown process cannot be executed (for example, a shutdown request cannot be accepted due to system deadlock), open the protective cover on the right upper part of the front panel and press the power switch for at least four seconds. The power is turned off and the equipment goes into the standby mode. If you turn off the power by pressing the power switch for at least four seconds, you cannot turn on the power by way of the LAN next time. Do not turn off the power this way except for emergencies. (See “2.7 Controlling the Power Using the LAN”.) For information about how to collect a memory dump, see “8.2 Collecting a Memory Dump”.

2. OPERATION

2.4 Power Shutdown

1. Confirm that the equipment is shut down. (See “2.3 Shutting Down the Equipment”.)
2. Turn off the main power switch.
3. When the main power is turned off, the standby lamp (STBY) is turned off.

2.5 Emergency Shutdown



WARNING

In case of smoke, a burning smell, or the like, unplug the power cord from the outlet, and contact your dealer or maintenance personnel. Using faulty equipment without repair may result in a fire or an electric shock.

NOTICE

- Performing emergency shutdown (that is, unplugging the power cord from the outlet or shutting off the breaker without proper shutdown of the OS) may cause the OS or applications not to work properly or may cause saved data to be corrupted. Do not perform emergency shutdown unless you must stop the system immediately due to some kind of error.
- If you turn off the power at the source of AC the power, the system may not be able to recover automatically.

In the following cases, turn off the power at the source of the AC power.

- When the equipment shows an error condition and you have to shut down the power immediately (for example, when a burning smell is detected).
- When you cannot shut down the equipment due to some error.
- When the power is turned off repeatedly or only the auxiliary power supply is on due to excess current or overheating.

In the following cases, remove the plug of power cord of this equipment from the outlet or turn off the power at the source of the AC power.

- If the fan is stopped and the temperature gets too high or too low and consequently the power is automatically turned off to protect the equipment and only the auxiliary power supply is on.

Before the OS starts, the BIOS can detect a stopped fan during BIOS start up and if detected, the power is automatically turned off.

After the OS starts, when a stopped fan is detected, the OS is automatically shut down and then the power is turned off (When already RAS was installed).

2.6 DVD drive

NOTICE

- If you insert or access a CD or DVD, the system load may increase and running applications may be affected. Do not insert or access an optical disc during online operation (system operation).
- When you finish accessing a CD or DVD, eject the disc from the DVD drive. If you leave the disc in the DVD drive, failure may result.
- If you keep the disc tray open, failure may result. When you do not intend to use the DVD drive, keep the disc tray inside the DVD drive.
- Do not use an unbalanced CD or DVD due to attached labels and so on; a disc with cracks, scratches, or vertical deviation; or a disc with a non-standard shape. If you do, an abnormal sound or vibration may be generated and failure of the equipment may result.

< NOTE >

- For information about the precautions for the DVD drive, see “PRECAUTIONS 5. DVDs”.

2. OPERATION

2.6.1 Inserting a CD or DVD

1. Press the eject button gently to open the disc tray.
2. Set the CD or DVD on the disc tray with the label side facing up.
3. Push the disc tray to load the disc into the DVD drive.

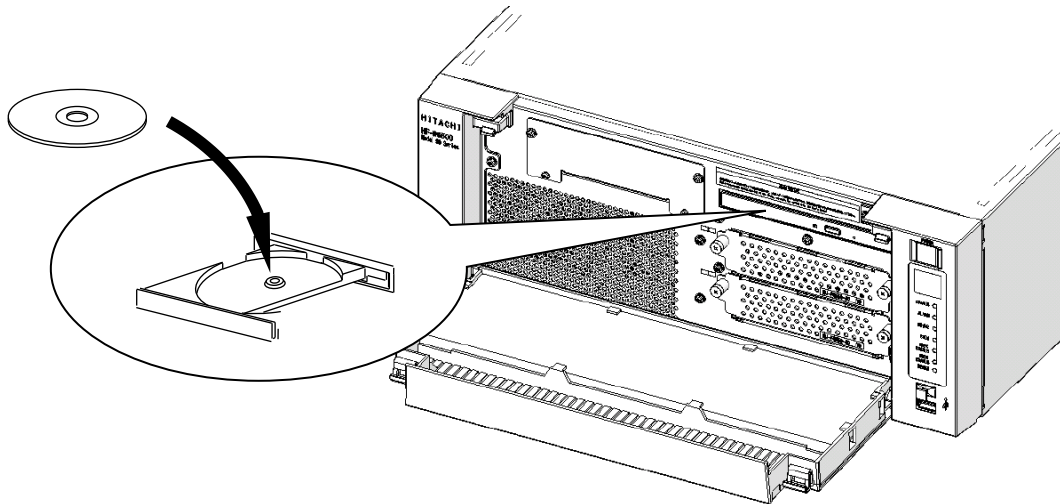

Front View When the Disc Tray Is Open

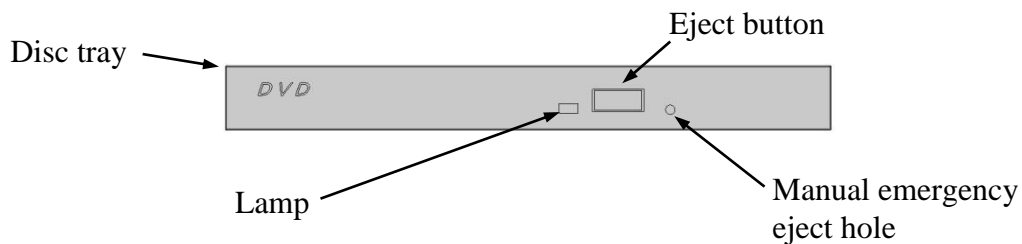

Front View of the DVD Drive

Figure 2-1 DVD Drive (Front View)

2.6.2 Ejecting a CD or DVD

1. Confirm that the lamp is neither on nor flashing (the drive is operating).
2. Press the eject button gently to open the disc tray.
3. Pick up the CD or DVD.

< NOTE >

- When you are writing to a CD or DVD, use the OS to eject the disc. If you press the eject button, writing to the disc may fail.

2.7 Controlling the Power Using the LAN

The power for this equipment can be turned on from a remote device by way of the LAN.

This section explains WOL (Wake ON LAN), which is used for turning on the power for the equipment through the LAN. When the power is turned on by using WOL, the equipment is started by sending a Magic Packet™ frame to the LAN interface when the standby lamp (STBY) is on.

In the initial factory settings, this function is disabled. If you want to use this function, follow steps 1 through 3 described in “2.7.1 Enabling the WOL (Wake ON LAN) function” to enable the WOL function and then follow the steps below.

< NOTE >

- For information about the precautions for the network, see “PRECAUTIONS 2. NETWORK”.

2.7.1 Enabling the WOL (Wake ON LAN) function

By following the procedure below, you can set up whether to start WOL when a Magic Packet™ frame is received. In the initial factory settings, the WOL function is disabled.

(The display image assumes Windows® 10 but it is similar under other OS.)

1. Execute steps 1 though 5 in “● Setting up the network transfer speed” in “2.8 Setting Up the LAN Interface”.
2. Click the **Power Management** tab. If you want to enable WOL, select the **Wake on Magic Packet from power off state** check box under **Wake on LAN** :
3. Click **OK** and restart the system.

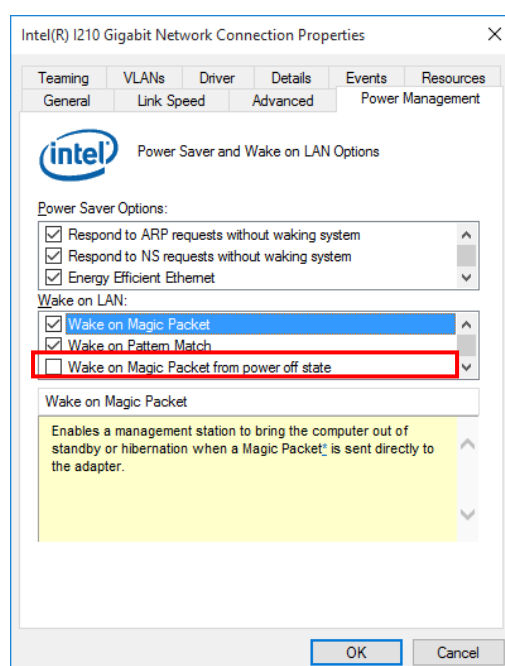

2.7.2 Turning on the power using the LAN

1. Insert the plug of the power cord into an outlet and turn on the main power. The standby lamp (STBY) will be lit.
2. Send a Magic Packet™ frame to the built-in LAN adapter in the equipment. When the built-in LAN adapter receives a Magic Packet™ frame, the power for the equipment is turned on.

You must turn on the standby lamp (STBY) in order to start the equipment through the LAN (using WOL). If you start the equipment and you want to continue to use WOL at the next startup, go through the shutdown process when you turn off the power.

The built-in LAN adapter in the equipment is compliant with WfM 2.0 (*1) to support the Magic Packet™ technology. Because of this, the power for the equipment can be turned on when a special data packet called a “Magic Packet™ frame” (*2) is received at the built-in LAN adapter.

A program for transmitting a Magic Packet™ frame does not come with the equipment. Use a commercially available program for to transmit the Magic Packet™ frame.

(*1) Wired for Management (WfM) is a guideline regarding the hardware specifications proposed by Intel Corporation for managing PCs on a network.

(*2) The Magic Packet™ technology has been proposed by AMD Japan, Ltd. and can be starting a PC on a network from a remote device.

< NOTE >

- When you send a Magic Packet™ frame to the equipment, make sure you send it to the built-in LAN adapter in the equipment. (For information about the location of the connector, see “1.5 Name and Function of Each Part”.) You cannot use WOL if you send a Magic Packet™ frame to an optional LAN adapter.
- If you turn off the power by pressing the power switch for at least four seconds, you cannot use WOL the next time. When you turn off the power by pressing the power switch for at least four seconds, turn on the equipment by pressing the power switch and go through the shutdown process to turn off the power.

< About the Magic Packet™ frame >

In a Magic Packet™ frame, the SOURCE ADDRESS, DESTINATION ADDRESS (the MAC address of the receiver or the MULTICAST ADDRESS including the BROADCAST ADDRESS), CRC, and the like must meet the basic requirements of the LAN in use. The data in a Magic Packet™ frame consists of a sequence of 16 repetitions of the MAC address of the node. This sequence can be anywhere in the packet but it must follow a synchronization stream. The synchronization stream is defined as 6 bytes of 0xFF. As long as the MAC address that repeats itself 16 times targets the address of the equipment to be started, the device can receive a BROADCAST frame.

A Magic Packet™ frame is shown in the following figure.

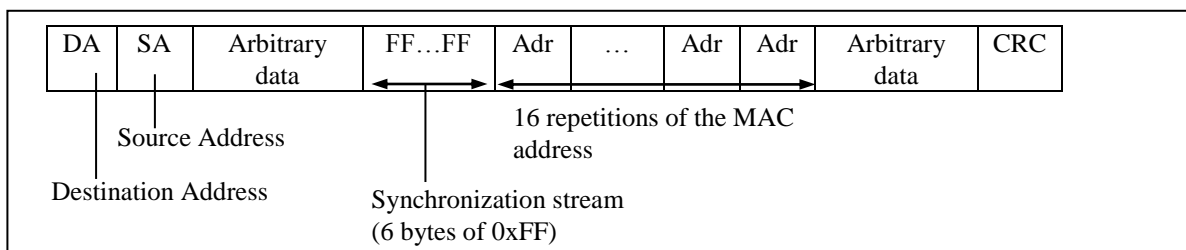

2.8 Setting Up the LAN Interface

This equipment has two built-in 1000BASE-T/100BASE-TX/10BASE-T LAN ports. For information about the location of the LAN port connector (1000BASE-T/100BASE-TX/10BASE-T), see “1.5 Name and Function of Each Part”.

< NOTE >

- For information about the precautions for the network, see “PRECAUTIONS 2. NETWORK”.

- Automatic recognition of the network transfer speed or transfer mode

The LAN port has an auto-negotiation function to automatically recognize the network transfer speed or transfer mode. For normal use, enable the auto-negotiation function. (Especially when you use the WOL function. If the speed is fixed to 1000Mbps (auto-negotiation), the WOL function cannot be used.)

If there is a compatibility issue with the connected hub, the auto-negotiation function may not work properly and that may affect the communication with other terminals.

If the auto-negotiation function does not work properly, configure the LAN interface as follows.

Table 2-1 Specification of the LAN setting

Specification of the hub	Specification of the LAN setting (*)	
	Speed	Duplex
10 Mbps / Half-duplex	10 Mbps	Half Duplex
10 Mbps / Full-duplex	10 Mbps	Full Duplex
100 Mbps / Half-duplex	100 Mbps	Half Duplex
100 Mbps / Full-duplex	100 Mbps	Full Duplex
1.0 Gbps	1.0 Gbps (1000 Mbps)	Auto Negotiation or Full Duplex

(*) How the setting is displayed is different depending on the OS and the LAN port (including the optional LAN adapter) in use.

- Setting the network transfer speed

(The display image assumes Windows® 10 but it is similar under other OS.)

1. Log on to the computer using an administrator's account.
2. Right-click **Start**. Then click **Device Manager**. The Device Manager window appears. (In Windows® 7, click **Start** > **Control Panel** > **System and Security** > **System** > **Device Manager**. Then go to step 3.)

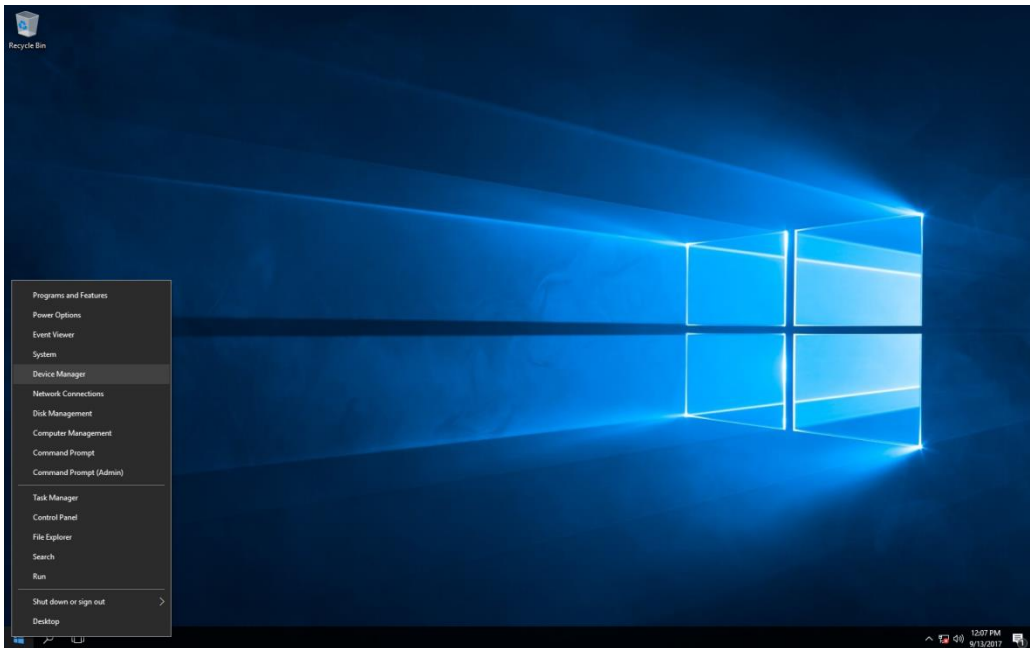

3. Click the **View** menu and select **Devices by connection**.

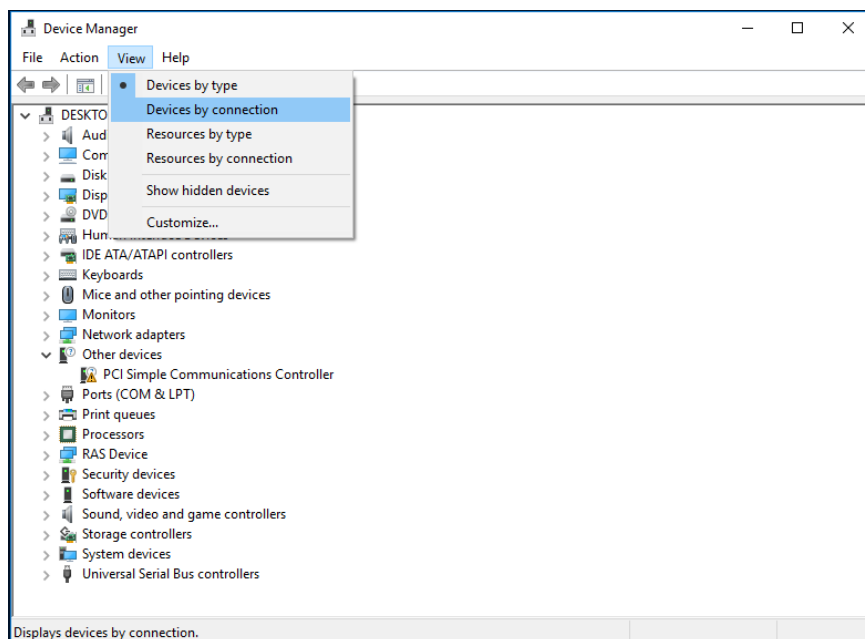

2. OPERATION

4. Click **ACPI x64-based PC > Microsoft ACPI-Compliant System > PCI Express Root Complex**.

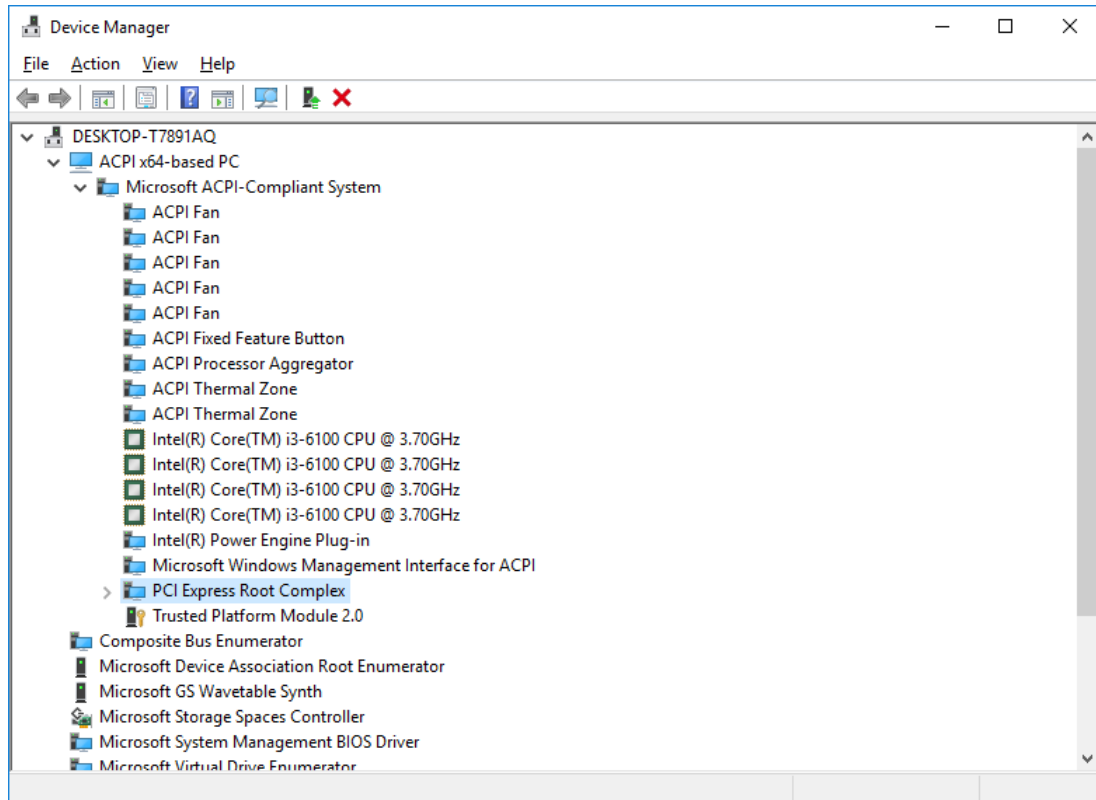

5. See the following and double-click the network adapter you want to configure and open **Network Connection Properties** window.

[When you configure the built-in LAN (LAN1)]

Click **Intel(R) 100 Series/C230 Series Chipset Family PCI Root Port #17 – A167**.

Then double-click the network adapter under it (in the example in the figure below, **Intel(R) I210 Gigabit Network Connection**).

[When you configure the built-in LAN (LAN2)]

Click **Intel(R) 100 Series/C230 Series Chipset Family PCI Root Port #18 – A168**.

Then double-click the network adapter under it (in the example in the figure below, **Intel(R) I210 Gigabit Network Connection#2**).

Follow a similar procedure when you update the setting for the network adapter mounted on an extension slot.

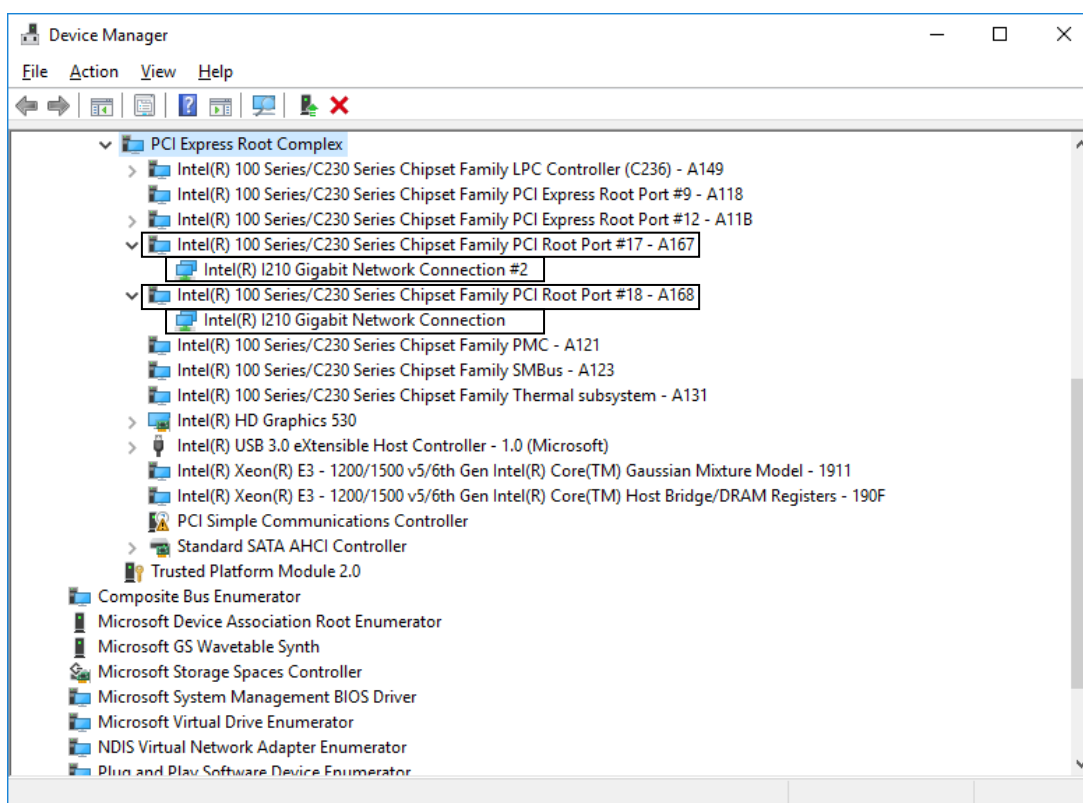

2. OPERATION

6. Click the **Link Speed** tab.

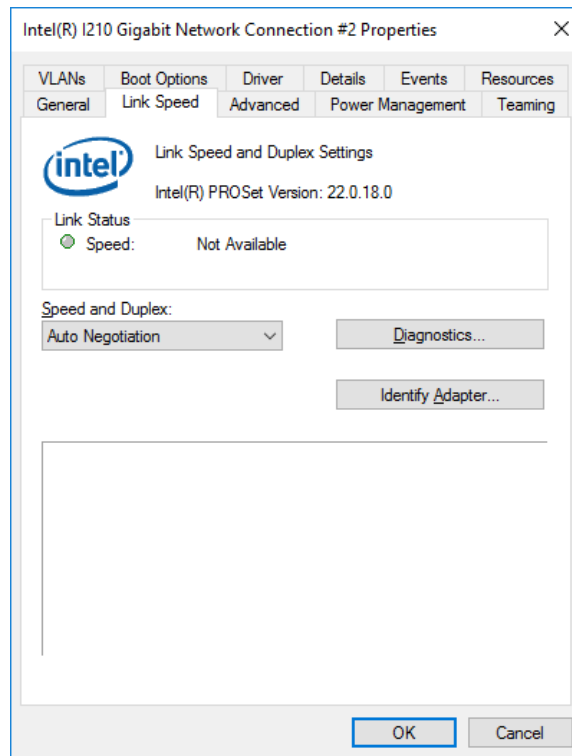

7. Select the transfer speed and the transfer mode you want to choose from the **Speed and Duplex** list.

- Auto Negotiation: auto-negotiation setting
- 10 Mbps Half Duplex: 10 Mbps/Half-duplex setting
- 10 Mbps Full Duplex: 10 Mbps/Full-duplex setting
- 100 Mbps Half Duplex: 100 Mbps/Half-duplex setting
- 100 Mbps Full Duplex: 100 Mbps/Full-duplex setting
- 1.0 Gbps Full Duplex: 1.0 Gbps/Full-duplex setting

If you do not have to configure the transfer speed and the transfer mode, select **Auto Negotiation** at the top of the list to choose the auto-negotiation setting.

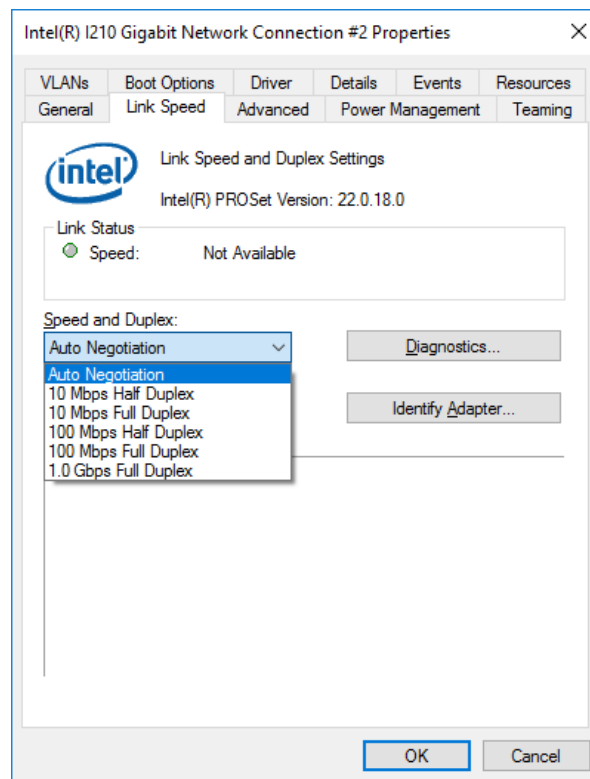

8. Click **OK**.

9. Close the **Device Manager** window.

< NOTE >

- For information about the precautions for the network, see "PRECAUTIONS 2. NETWORK".

2. OPERATION

- Action to take if the link is unstable at 1.0 Gbps

Depending on the type of the connected hub, the link may not be stable at 1.0 Gbps. If you want to use the network at 1.0 Gbps, verify the connection with the hub in advance.

If the link is unstable at 1.0 Gbps, it is made stable by taking the following action.

- Use a cable which is 20 to 100 meters long (UTP Category 5e or better).
- Fix the master/slave mode setting to Master (valid only in the 1.0 Gbps setting).

Follow the procedure below to fix the mater/slave mode to Master. The link may not function depending on the type of the hub. In this case, re-set the setting to **Auto Detect**.

1. Execute steps 1 though 5 in “● Setting the network transfer speed” in “2.8 Setting Up the LAN Interface”.
2. Click the **Advanced** tab. Select **Gigabit Master/Slave Mode** from the **Settings** list.
3. From the **Value** pull-down menu, select **Force Master Mode**.
4. Click **OK** and restart the equipment.

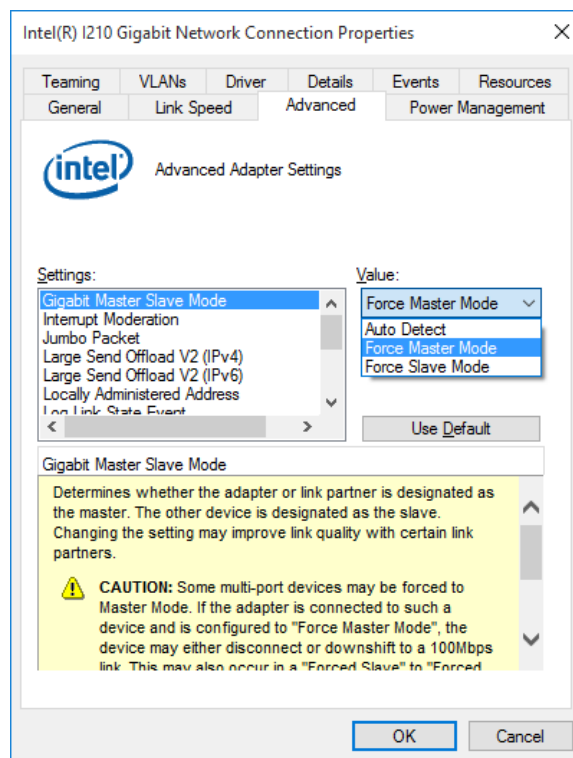

- Precautions for mounting and using multiple LAN adapters

If multiple LAN adapters are mounted and there are frequent interrupt requests from either of the adapters or the amount of processed data is too large, the performance of the adapters may not be as high as expected. (This is because an interrupt request from a LAN adapter requires a higher CPU load compared to the amount of processed data and if multiple LAN adapters are mounted and used, it takes a very long time for the CPU to process all interrupt requests from the LAN adapters.)

If you mount and use multiple LAN adapters, confirm that each built-in LAN adapter and optional adapter can perform as expected. If they do not, adjust the network load or change the LAN adapter settings by following the procedure below. For details about each configuration item, see the description at the bottom of the corresponding setup window.

(The display image assumes Windows® 10 but it is similar under other OS.)

1. Execute steps 1 through 5 in “● Setting the network transfer speed” in “2.8 Setting Up the LAN Interface”.
2. Click the **Advanced** tab. Select **Performance Options** and click **Properties**.
The **Performance Options** dialog box is displayed.

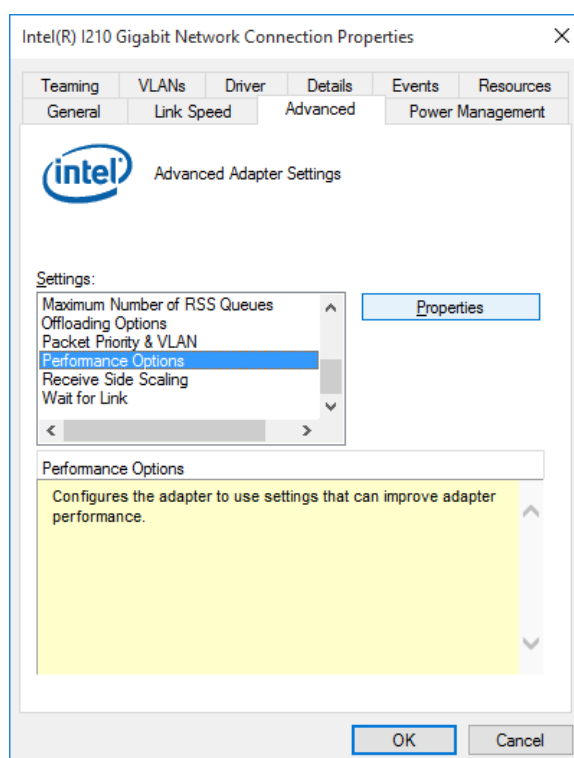

2. OPERATION

- DMA Coalescing

Sets an upper limit on the maximum amount of latency applied to any network packet due to direct Memory Access(DMA) Coalescing.

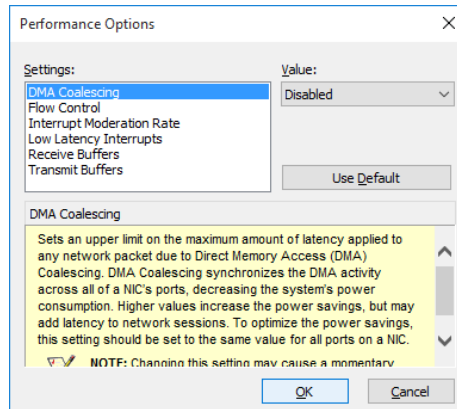

- Flow Control

This enables adapters to generate or respond to flow control frames, which help regulate network traffic. The default setting of the flow control is different depending on the OS and the type of LAN adapter in use. You must configure the flow control setting according to the network you are using.

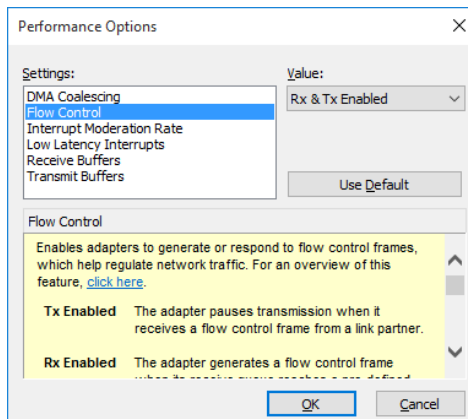

< NOTE >

- If the LAN driver stops due to a system failure such as an OS deadlock, broadcast frames from other devices may not be able to be processed and the receive queue may get full.
If **Rx Enabled** or **Rx & Tx Enabled** is specified for **Flow Control**, flow control frames are continuously sent from this equipment under such a condition. If this happens, that may affect the whole network connected to the equipment. Specify **Disabled** for **Flow Control** at this equipment or at the connected hub as required.
- If **Disabled** is specified for **Flow Control** and if the device receives frames quicker than it can process, the device gets overloaded, and the frames receive will be discarded until the device recovers from the overload condition. You have to design the network appropriately to avoid such an overload condition.

- **Interrupt Moderation Rate**

This sets the rate at which the controller moderates or delays the generation of interrupts.

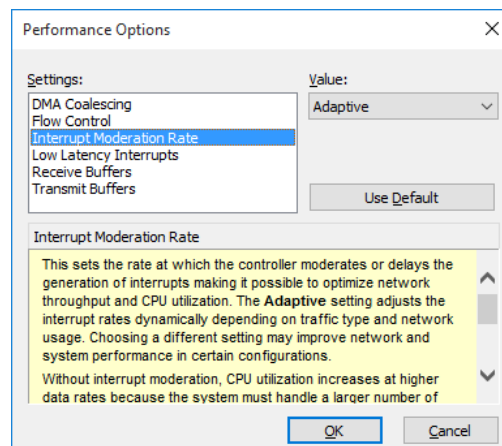

- **Receive Buffers**

This sets the number of Receive Buffers used by the driver when copying data to protocol memory.

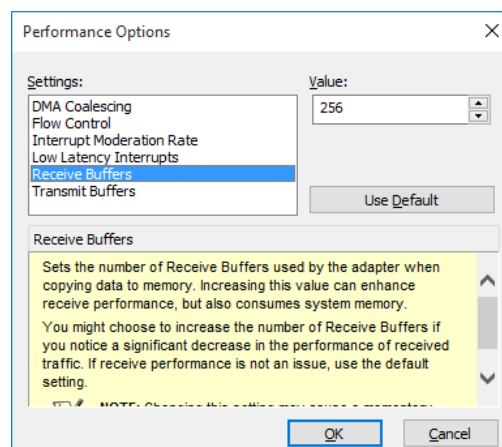

- **Transmit Buffers**

This sets the number of Transmit Buffers, data segments used by the adapter when recording transmission packets in system memory.

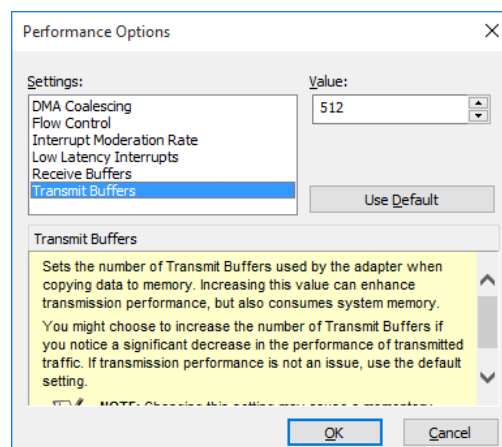

2. OPERATION

- Low Latency Interrupt

Enables adapters to bypass interrupt moderation and immediately generate an interrupt when certain TCP packets arrive, allowing the system to handle the packet more quickly.

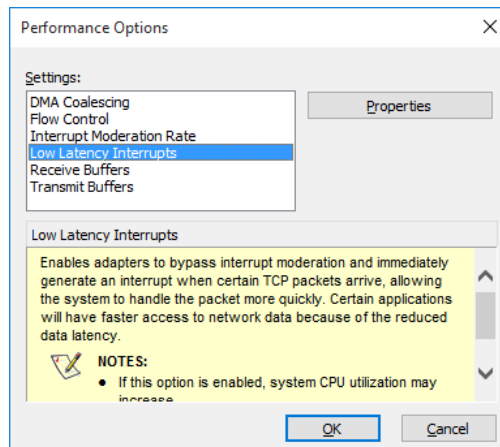

- Notes about the case when link down is recorded in the log during OS startup.

While Windows® is starting, the following warnings may be displayed in the event log.

These warnings are recorded by the initialization process of the LAN driver at the startup of Windows® and will not cause any problems in the system operation.

Event ID	Source	Type	Category	Description(*1)
27	e1repress	Warning	None	Intel(R) I210 Gigabit Network Connection(*1) Network link is disconnected.(*2)

(*1) How the name is displayed differs depending on the LAN adapter

(*2) How the contents are displayed differs depending on the OS.

You can keep these warnings from being displayed in the event log by changing the LAN adapter settings as follows.

Note that if you change the settings shown below, log entries such as LAN connection and disconnection during system operation are also not recorded and that may make failure analysis difficult when a problem occurs.

(The display image assumes Windows® 10 but it is similar under other OS.)

1. Execute steps 1 through 5 in “● Setting the network transfer speed” in “2.8 Setting Up the LAN Interface”.
2. Click the **Advanced** tab. Select **Log Link State Event**. Select **Disabled** from the **Value** list.

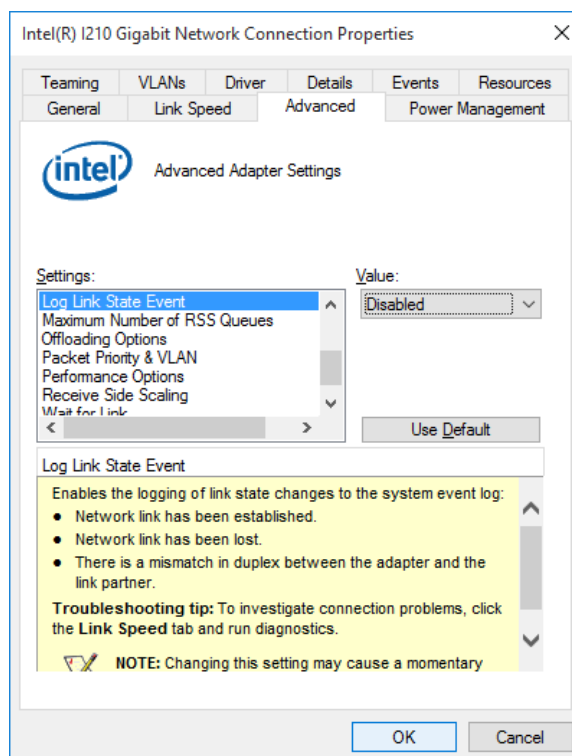

2.9 Setting Up the Screen

For screen settings, you can configure resolution (the number of dots that constitutes the screen), refresh rate (the number of screen refreshes per second), and the single- display and multiple-display settings.

(The display image assumes Windows® 10 but it is similar under other OS.)

< NOTE >

- For information about the precautions for the screen, see “PRECAUTIONS 3. DISPLAY SCREEN”.
- When you want to change screen settings, use "Intel® HD Graphics Control Panel" and change the screen settings.

(1) Configuring screen settings for a single display

When one display is connected, follow the procedure below to configure the screen settings.

1. Right-click on the desktop to display a menu. From the menu, click **Intel® Graphics Setting** to start **HD Graphics Control Panel**.

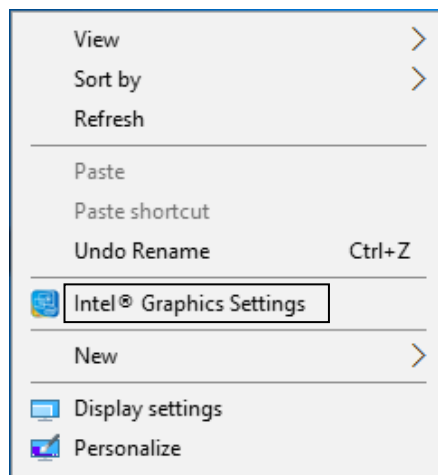

2. In the **HD Graphics Control Panel** window, click **Display**.

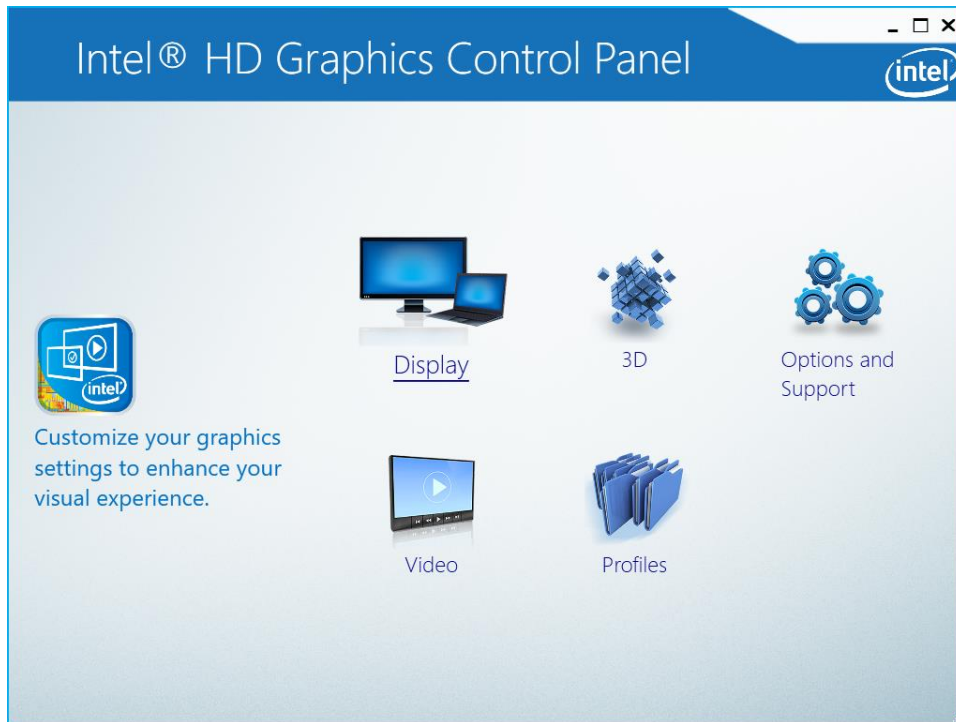

3. Configure the screen setting items displayed on the middle of the window.

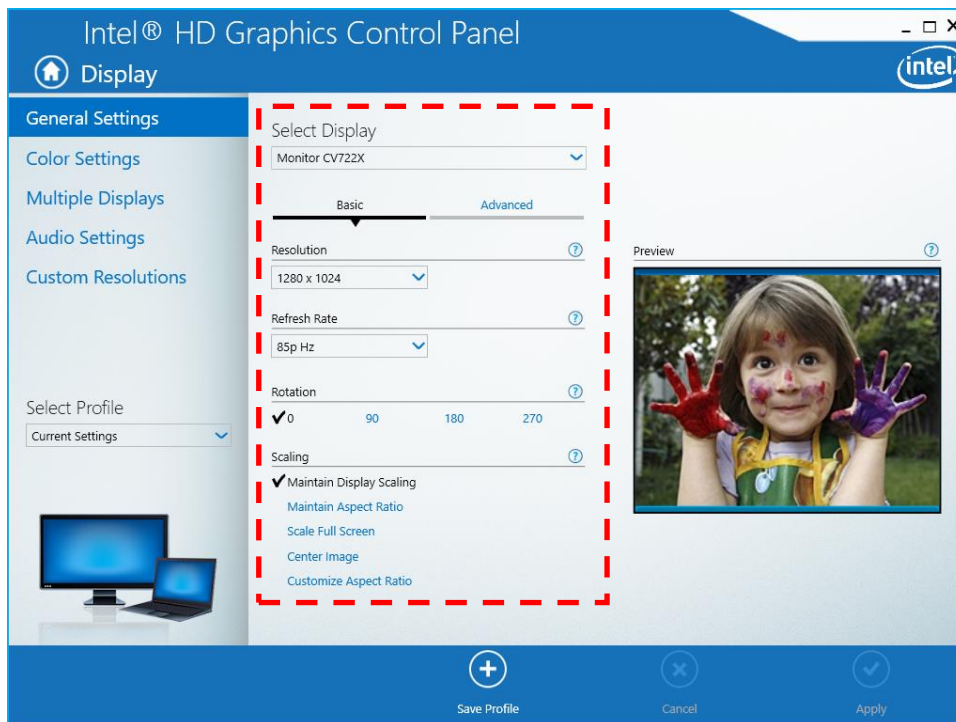

Setting Item	Description
Resolution	This allows you to select the resolution.
Refresh Rate	This allows you to select the refresh rate.

2. OPERATION

< NOTE >

- Do not change the Rotation and Scaling settings.
- When you configure the resolution, color depth, and refresh rate, you must choose from the options described in “5.1 Equipment Specifications (6) Supported resolutions”.

4. When you finish configuring the setting items, click **Apply**. If you change the resolution or refresh rate, the following confirmation screen for the configuration change will be displayed. Click **Yes**.

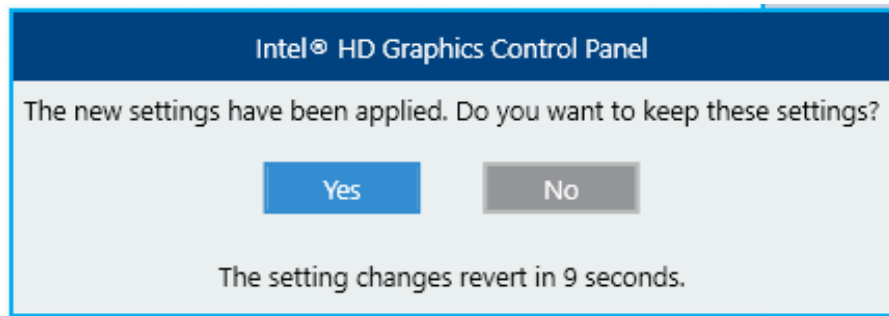

< NOTE >

- The resolution options may include resolutions larger than the resolutions supported by the connected display.
- If you select a resolution larger than the maximum resolution supported by the display, the display will black out.
- After the driver is installed, the resolution is automatically set to the maximum resolution supported by the connected display. When you change the resolution, select a resolution smaller than that.

(2) Configuring screen settings for two (multiple) displays

This equipment supports multiple display output. If you connect two displays, the two displays can be used simultaneously. The following shows how to set up the multiple display output.

1. As described in "(1) Configuring screen settings for a single display", start **Intel® HD Graphics Control Panel > Display**.
2. Click **Display** at the upper left corner in the window, and then click **Multiple Displays**. Then configure the settings for multiple displays.

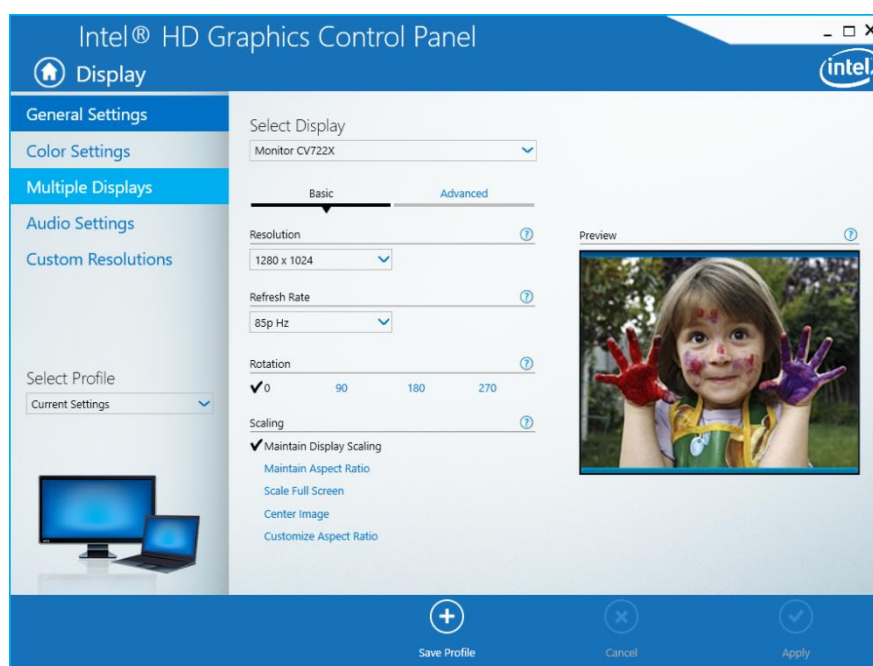

The following shows how to set up “Clone”, “Extended” and “Collage”.

< NOTE >

- The multi-stream function (daisy chain) of DisplayPort is not supported.

2. OPERATION

(a) Clone

If you select this mode, both displays show the same screen and have the same resolution, color depth, and refresh rate. Before connecting displays, check the capabilities of the displays (maximum resolution, highest refresh rate, and so on).

1. Select **HD Graphics Control Panel > Display > Multiple Displays**.
2. Select **Select Display Mode > Clone**.

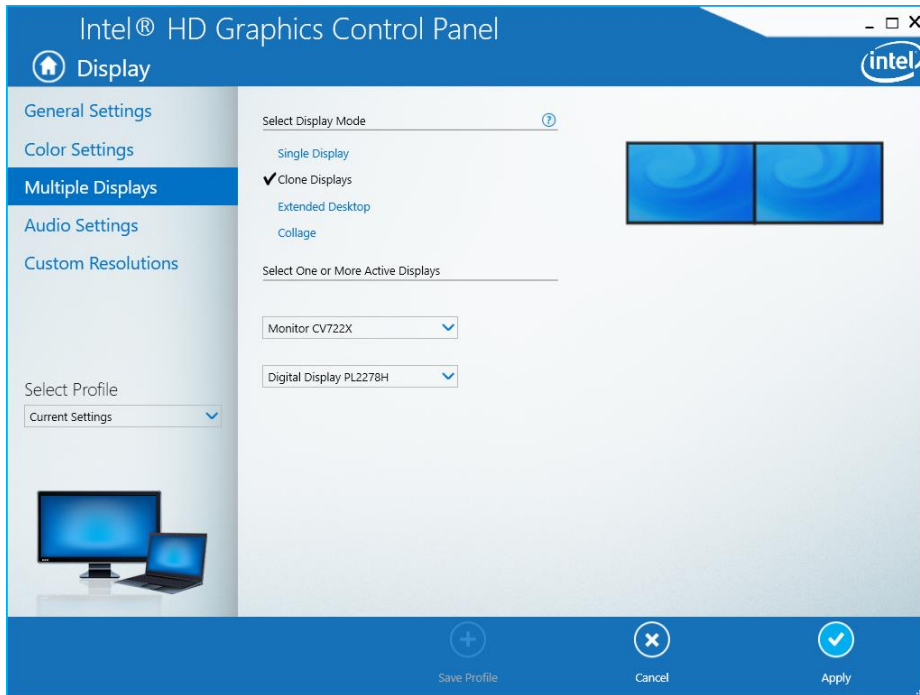

3. When you finish configuring the settings, click **Apply**. If you change the resolution or refresh rate, the following confirmation screen for the setting change will be displayed. Click **Yes**.

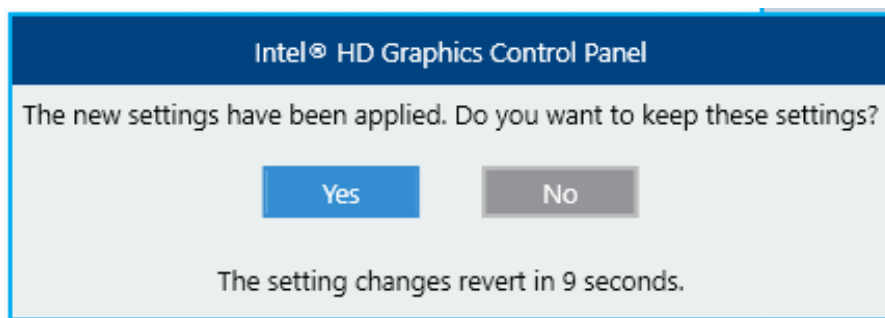

(b) Extended

If you select this mode, one screen is divided into two and displayed on two displays. The resolution, color depth, and refresh rate can be configured independently. The task bar is not displayed in display 2. Which resolution, color depth, and refresh rate can be selected depends on the capabilities of the display connected.

1. Select **HD Graphics Control Panel > Display > Multiple Displays**.
2. Select **Select Display Mode > Extended**.

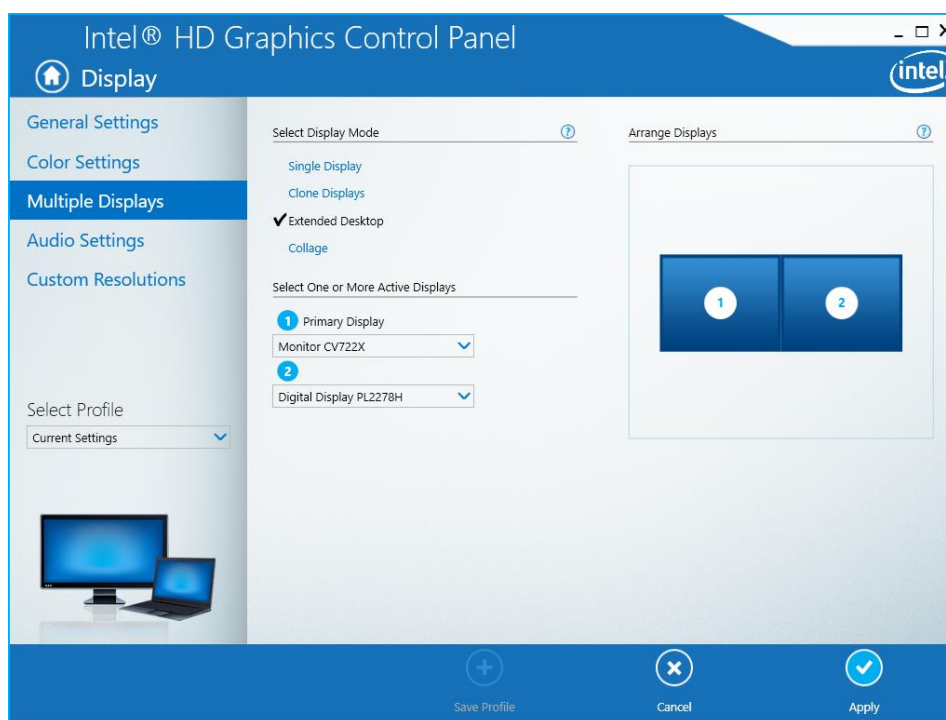

3. When you finish configuring the settings, click **Apply**. If you change the resolution or refresh rate, the following confirmation screen for the setting change will be displayed. Click **Yes**.

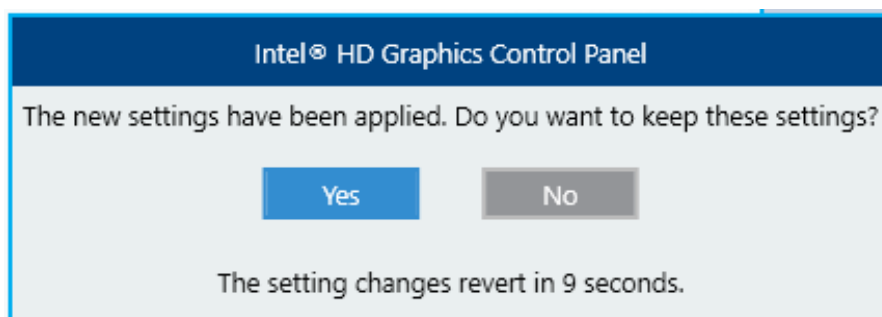

2. OPERATION

(c) Collage

This feature allows one screen to be divided and displayed on multiple displays. The screen resolution is the sum of the resolutions of all displays. For example, if you enable Collage with two displays placed side by side, the horizontal resolution becomes the sum of the horizontal resolutions of the two displays. The resolution, color depth, and refresh rate settings are the same for all displays. The task bar is displayed only in the main display. Which resolution, color depth, and refresh rate can be selected depends on the capabilities of the connected displays.

1. Start **HD Graphics Control Panel > Display > Multiple Displays**.
2. Under **Select Display Mode**, select **Collage**.



3. Under **Enable**, select **On**.

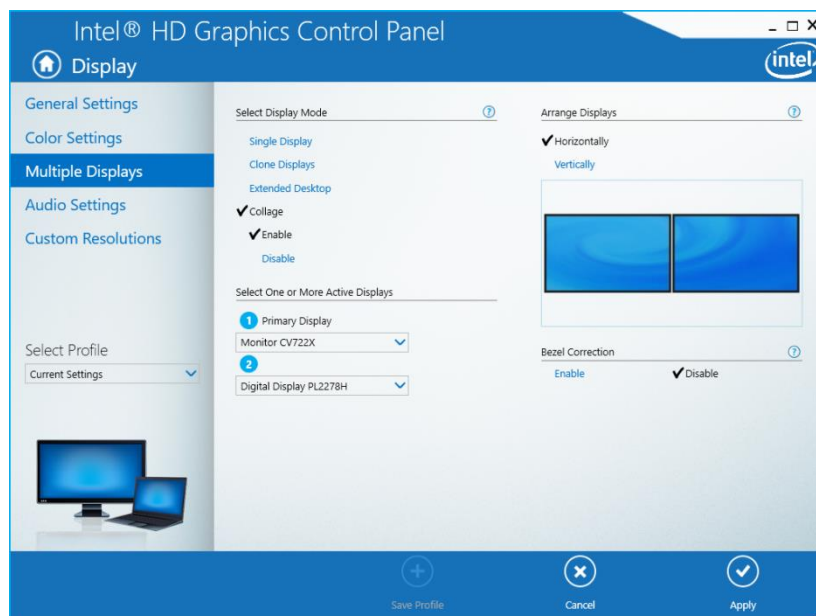

4. When you finish configuring the settings, click **Apply**. If you change the resolution or refresh rate, the following confirmation screen for the setting change will be displayed. Click **Yes**.

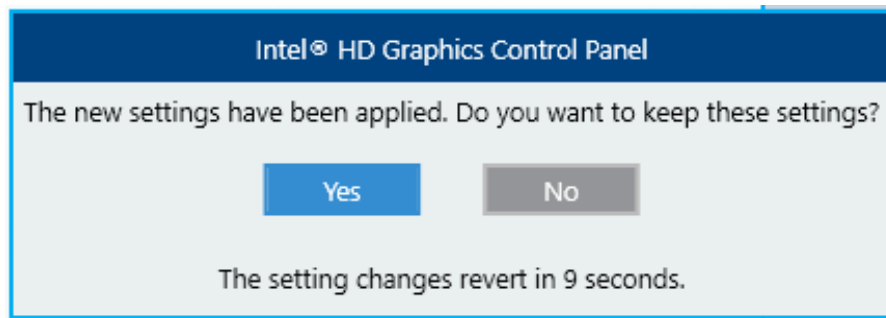

This Page Intentionally Left Blank

CHAPTER 3 SETUP

3.1 Setup Procedure When You Turn On the Power for the First Time

3.1.1 Setting up Windows® 10

This section describes the procedure for setting up the preinstalled Windows® 10.

- Set basic items of Windows® 10.
- The RAS function is automatically set up.
- This setup procedure takes about 20 minutes.

- Preparation for setup

The following items are required during the setup procedure. Prepare (check) them in advance before starting the setup procedure.

Item	Description
License certificate	Confirm that the license certificate is attached to the body of this computer.
User name	The user name of an administrator account of the computer. You can later change it in Control Panel.
Administrator's password	Password of the administrator This password can be changed later on the control panel.

3. SETUP

- Windows® 10 setup procedure

Perform the following procedure to set up Windows® 10.

1. Turn on this equipment.

Windows starts running and setup is prepared.

Then, the message “Setup is installing devices. Please wait...” appears, indicating that installation of the device driver is in progress.

- This processing may take several minutes. Please wait until it is completed.
- After the OS reboots, Setup goes on.

2. The **Here's the legal stuff** window opens.

- Check the contents, and then click the **Accept** button.

3. The **Get going fast** window opens.

- Click **Customize**.
- Select ON or OFF for settings as needed, and then click the **Next** button.

4. The **Create an account for this PC** window opens.

- Type a user name in **Who's going to use this PC?**
- Type a password in **Enter password** in **Make it secure**.
- Retype the password in **Re-enter password**.
- Type a hint of password in **Password hint**.
- Click the **Next** button.

< NOTE >

Rarely you can not type Japanese when typing a password hint.

In this case, type Japanese by the following method.

- Move the input point to **Who's going to use this PC?** and check whether you can type Japanese. If you can type Japanese, move the input point to **Password hint** and check if you can type Japanese.
- If you can not enter Japanese even if the above correspondence is done, reset password after setup and enter hint of password.

5. After the setup has been completed, the sign in operation is performed automatically.

6. The **Partition Size Setting** window opens.

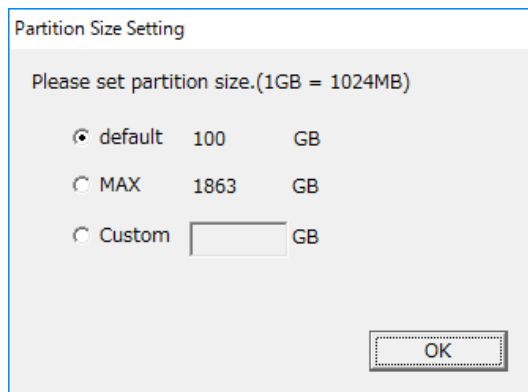

- The capacity of the factory default setting (**default**) and the maximum value (**MAX**) of the range that can be created is displayed, so select the capacity you want to create and click the **OK** button. The minimum value of the range that can be created is the capacity of the factory default setting (**default**).
- When you directly type the capacity, select the custom (**Custom**), type the partition capacity in GB units (1 GB = 1,073,741,824 bytes), and click the **OK** button.

In case of selecting the custom (**Custom**) and clicking the **OK** button, if the value outside the allowable range is typed, the following message will be displayed. Click the **OK** button and re-type the partition capacity.

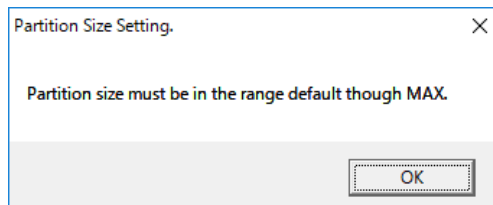

7. The confirmation window for partition capacity setting displayed.
Click the **OK** button if the displayed partition capacity is OK.

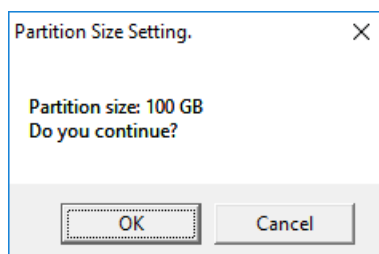

3. SETUP

8. When the partition capacity setting is successful, the following message is displayed.
Click the [OK] button. Exit the dialog.

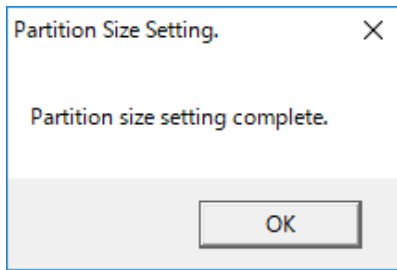

This completes Windows® 10 setup. From this point on, follow the instruction in “3.2 Configuring Basic Settings after OS Setup” to configure the basic settings of the OS.

3.1.2 Setting up Windows Server® 2016

This section describes the procedure for setting up the preinstalled Windows Server® 2016.

- Set basic items of Windows Server® 2016.
- The RAS function is automatically set up.
- This setup procedure takes about 30 minutes.

- Preparation for setup

The following items are required during the setup procedure. Prepare (check) them in advance before starting the setup procedure.

Item	Description
License certificate	Confirm that the license certificate is attached to the body of this computer.
User name	The user name of an administrator account of the computer. You can later change it in Control Panel.
Administrator's password	Password of the administrator This password can be changed later on the control panel.

3. SETUP

- Windows Server® 2016 setup procedure

Perform the following procedure to set up Windows Server® 2016.

1. Turn on this equipment.

Windows starts running and setup is prepared.

Then, the message “Setup is installing devices. Please wait...” appears, indicating that installation of the device driver is in progress.

- This processing may take several minutes. Please wait until it is completed.
- After the OS reboots, Setup goes on.

2. The **Here's the legal stuff** window opens.

- Check the contents, and then click the **Accept** button.

3. The **Get going fast** window opens.

- Click **Customize**.
- Select ON or OFF for settings as needed, and then click the **Next** button.

4. The **Create an account for this PC** window opens.

- Type a user name in **Who's going to use this PC?**
- Type a password in **Enter password** in **Make it secure**.
- Retype the password in **Re-enter password**.
- Type a hint of password in **Password hint**.
- Click the **Next** button.

< NOTE >

Rarely you can not type Japanese when typing a password hint.

In this case, type Japanese by the following method.

- Move the input point to **Who's going to use this PC?** and check whether you can type Japanese. If you can type Japanese, move the input point to **Password hint** and check if you can type Japanese.
- If you can not enter Japanese even if the above correspondence is done, reset password after setup and enter hint of password.

5. After the setup has been completed, the sign in operation is performed automatically.

6. The **Partition Size Setting** window opens.

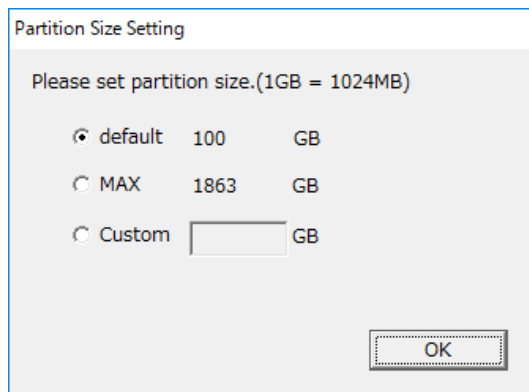

- The capacity of the factory default setting (**default**) and the maximum value (**MAX**) of the range that can be created is displayed, so select the capacity you want to create and click the **OK** button. The minimum value of the range that can be created is the capacity of the factory default setting (**default**).
- When you directly type the capacity, select the custom (**Custom**), type the partition capacity in GB units (1 GB = 1,073,741,824 bytes), and click the **OK** button.

In case of selecting the custom (**Custom**) and clicking the **OK** button, if the value outside the allowable range is typed, the following message will be displayed. Click the **OK** button and re-type the partition capacity.

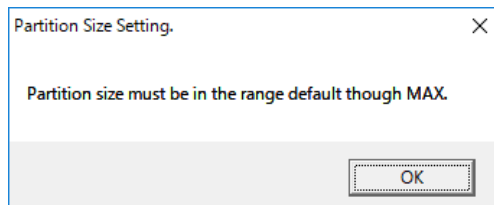

7. The confirmation window for partition capacity setting displayed.
Click the **OK** button if the displayed partition capacity is OK.

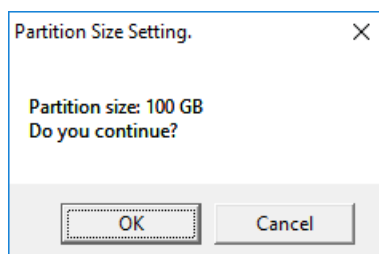

3. SETUP

8. When the partition capacity setting is successful, the following message is displayed.
Click the [OK] button. Exit the dialog.

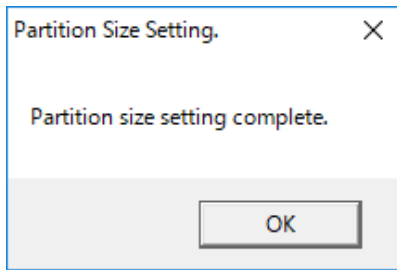

This completes Windows Server® 2016 setup. From this point on, follow the instruction in “3.2 Configuring Basic Settings after OS Setup” to configure the basic settings of the OS.

3.1.3 Setting up Windows® 7

This section describes the setup procedure of the pre-installed Windows® 7.

- Basic settings of Windows® 7 are configured.
- The setup of the RAS feature is automatically done.
- The procedure takes about 30 minutes.

- Preparing the setup

The following items are necessary for the setup work. Before you start the setup work, decide or check those items beforehand.

Item	Description
License certificate	Make sure that the license certificate is attached to the body of the product.
Display language	<p>Display language of Windows® 7 Professional</p> <p>This equipment offers a Windows® Multilingual User Interface (MUI), and you can set the display language of Windows® itself to one of the following languages:</p> <ul style="list-style-type: none"> • English • Portuguese • Thai • Korean • Chinese (Traditional) • Chinese (Traditional (ROC)) • Chinese (Simplified) • Japanese <p>You cannot change the settings later. In order to change the display language after setup is complete, use a recovery DVD to restore the contents of the system drive back to the factory-shipped condition, and then restart OS setup.</p> <p>For information about how to use a recovery DVD to restore the contents of the system drive back to the factory-shipped condition, see “CHAPTER 3 RESTORING THE FACTORY-SHIPED CONDITION USING A RECOVERY DVD”.</p>
Country or region	Country or region of your location You can later change it in Control Panel.
Time and currency format	The format used for displaying time and currency. You can later change it in Control Panel.
Keyboard or input method	The layout of the keyboard You can later change it in Control Panel.
User name	The user name of an administrator account of the computer. You can later change it in Control Panel.
Password	The password for the user name. You can later change it in Control Panel.
Computer name	<p>The name used for identifying the computer on the network.</p> <ul style="list-style-type: none"> • This name is used for identify the computer on the network. Select a unique name on the network. <p>You can later change it in Control Panel.</p>

3. SETUP

●Windows® 7 setup procedure

Perform the following procedure to set up Windows® 7.

1. Turn on this equipment.

Windows starts and prepares for the setup.

Then, a message "Setup is installing devices. Please wait..." is displayed to indicate that device drivers are being installed.

- This process may take a couple of minutes. Just wait until this process is complete.

After a while after rebooting, Windows ® 7 setup window opens.

2. A window is displayed to select a display language.

Select a display language and then click **Next**. For example, if you want to select the English language, select **My language is English** from the list.

(It should be noted that the language used in the window is changed to the specified display language immediately after you select the language.)

The correspondence between the display language and the notation in the list is as in the table below. (In the same order as in the list)

Display language	Notation in the list
English	My language is English
Portuguese	O meu idioma é português (Portugal)
Thai	ภาษาของฉันคือไทย
Korean	내 언어: 한국어
Chinese (Traditional)	我的語言是中文 (繁體)
Chinese (Traditional (ROC))	我的語言是中文 (繁體) (中華民國)
Chinese (Simplified)	我的语言是中文 (简体)
Japanese	私の言語: 日本語

< NOTE >

- After this point, Windows® 7 uses the language specified here as the language used on the screen. In this manual and other manuals of this product, explanations are based on the assumption that English is used on the screen. If you use a language other than English as the display language, translate expressions in the explanations to the display language as required.
- In Windows® 7, you cannot change the display language after OS setup is complete. In order to change the display language after setup is complete, use a recovery DVD to restore the contents of the system drive back to the factory-shipped condition and then restart OS setup. For information about how to use the recovery DVD to restore the contents of the system drive back to the factory-shipped condition, see "CHAPTER 7 RESTORING THE FACTORY-SHIPPED CONDITION USING A RECOVERY DVD".

3. A setup screen for the country or region, the time and currency format, and the keyboard or input method settings appears.

- If the English language was selected at step 2, just leave the settings as they are and click **Next**.
- If you selected a language other than English, configure the country or region, the time and currency format, and the keyboard or input method settings as required and click **Next**.

The time and currency format setting must be configured based on the display language you selected at step 2 as the following table shows.

Display language	Time and currency format
English	English (United States)
Portuguese	Português (Portugal)
Thai	ไทย (ประเทศไทย)
Korean	한국어(대한민국)
Chinese (Traditional)	中文 (繁體, 香港特別行政區)
Chinese (Traditional (ROC))	中文 (繁體, 台灣)
Chinese (Simplified)	中文 (简体, 中国)
Japanese (Japan)	日本語 (日本)

< NOTE >

The time and currency format setting can be changed after OS setup is complete. Select **Control Panel > Clock, Language, and Region** and then click **Region and Language**. The **Regional and Language Option** window opens. Configure the time and currency format setting on the **Formats** tab.

4. The user name input window is displayed.

- Enter the user name and the computer name and click **Next**.

< NOTE >

The computer name is automatically generated by appending “-PC” to the end of the user name. Note that if you select the Thai language at step 2, this automatically generated computer name cannot be used as is. Delete the characters that have been automatically added to the end of the user name, and then edit the computer name. You can use the following characters in the computer name: alphabetic characters (“a” through “z” and “A” through “Z”), numeric characters (0 through 9), and the hyphen-minus (“-”).

3. SETUP

5. The password input window is displayed.
 - Enter a password in the **Type a password** box and in the **Retype your password** box.
 - Enter a password hint in the **Type a password hint** box.
 - Click **Next**.
6. The **Please read the license terms** window is displayed.
 - Check the displayed contents and select the **I accept the license terms** check box.
 - Click **Next**.
7. The **Help protect your computer and improve Windows automatically** window is displayed.
 - Click **Ask me later**.
8. The **Review your time and date settings** window is displayed.
 - Configure the time zone, the date and the time.

< NOTE >

Regardless of the display language selected at step 2, "(UTC)Coordinated Universal Time" is selected as the time zone by default. Set the time zone according to the actual location where this equipment is used.

- Click **Next**.
9. After the setup has been completed, this equipment is automatically logged on the Windows and then the message "Please wait. The system will restart automatically" is displayed in the command prompt. Wait to restart automatically.
 10. After the log-on window is displayed, enter the password and log on to the Windows.

11. The **Partition Size Setting** window opens.

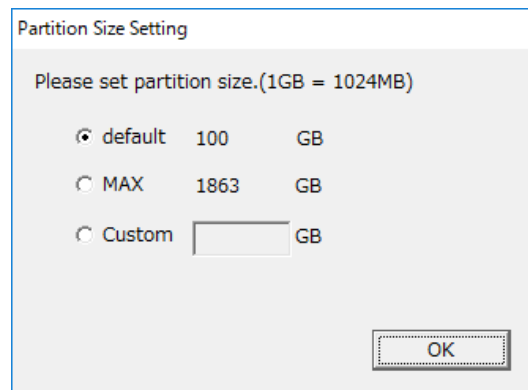

- The capacity of the factory default setting (**default**) and the maximum value (**MAX**) of the range that can be created is displayed, so select the capacity you want to create and click the **OK** button. The minimum value of the range that can be created is the capacity of the factory default setting (**default**).
- When you directly type the capacity, select the custom (**Custom**), type the partition capacity in GB units (1 GB = 1,073,741,824 bytes), and click the **OK** button.

In case of selecting the custom (**Custom**) and clicking the **OK** button, if the value outside the allowable range is typed, the following message will be displayed. Click the **OK** button and re-type the partition capacity.

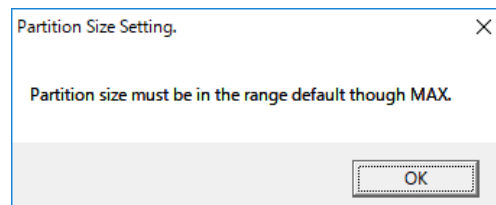

12. The confirmation window for partition capacity setting displayed.

Click the **OK** button if the displayed partition capacity is OK.

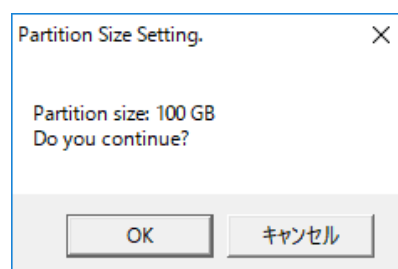

3. SETUP

13. When the partition capacity setting is successful, the following message is displayed.
Click the [OK] button. Exit the dialog.

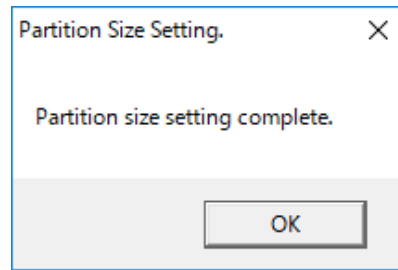

This completes Windows® 7 Professional setup. From this point on, follow the instruction in “3.2 Configuring Basic Settings after OS Setup” to configure the basic settings of the OS.

< NOTE >

A message “Configuring Windows features **% complete Do not turn off your computer.” may be displayed when the OS shuts down (or reboots) shortly after you complete the setup. This message is displayed when the display language resources that you did not choose during the setup are deleted. This process may take a couple of minutes. Just wait until this process is complete. When the process is complete, the power will be turned off (or the OS will restart) automatically.

3.2 Configuring Basic Settings after OS Setup

3.2.1 Basic Settings for Windows® 10 and Windows Server® 2016

This section describes the basic settings procedure of the preinstalled Windows® 10 and Windows Server® 2016.

Perform this procedure as needed after the setup of OS according to “3.1 Setup Procedure Required after the First Power-on”.

3.2.1.1 Outline of basic settings procedure

Setting up the network environment	➔	See “2.8 Setting Up the LAN Interface”.
Setting up the screen	➔	See “2.9 Setting Up the Screen”.
Setting up auto-update	➔	See “3.2.1.2 Setting Up Auto-update”. • The procedure takes about 5 minutes.
Only MUI version Setting up display language	➔	See “3.2.1.3 Setting Up display language”. • The procedure takes about an hour.

3. SETUP

3.2.1.2 Setting Up Auto-update

Windows® 10 and Windows Server® 2016 settings allow update programs delivered from Windows Update to be applied automatically. The system and application update programs are regularly checked and are automatically downloaded and installed.

The following two options are selectable for the auto-update setting of Windows® 10 and Windows Server® 2016.

(1) Automatic (recommended)

Update programs are automatically downloaded and installed and the OS restarts. (“Automatic” is selected by default.)

(2) Notify to schedule restart

Update programs are automatically downloaded and installed and a notice to specify the restarting date/time is given.

Perform the following procedure to set auto-update.

1. Click the **Start** button, and then click **Settings** from the displayed menu.
2. Click **Update & security**. The Windows Update window opens.
3. Click **Advanced options**, specify **Automatic** or **Notify to schedule restart** in **Choose how updates are installed**, and then click the × button.

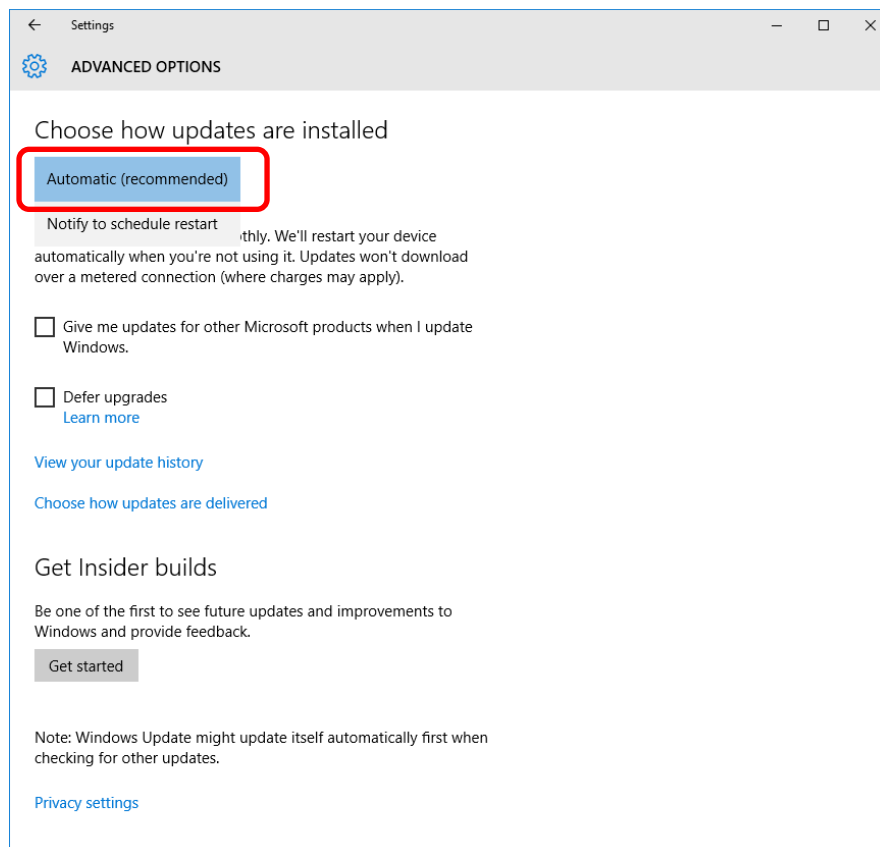

[Enabling manual update of Windows Update]

If you do not want auto download and installation of update programs, you can set Windows Update to manual update by using the local group policy editor (gpedit.msc). The following describes the procedure to set Windows Update to manual update.

1. Sign in the computer with a computer's administrator account.
2. Right-click the **Start** button, and then click **Run**.
3. On the **Run** window, type "gpedit.msc" to activate the Local Group Policy Editor.
4. On the **Local Group Policy Editor** window, click **Computer Configuration – Administrative Templates - Windows components - Windows Update - Configure Automatic Updates**.
5. On the **Configure Automatic Updates** window, select **Disabled**, and then click the **OK** button.

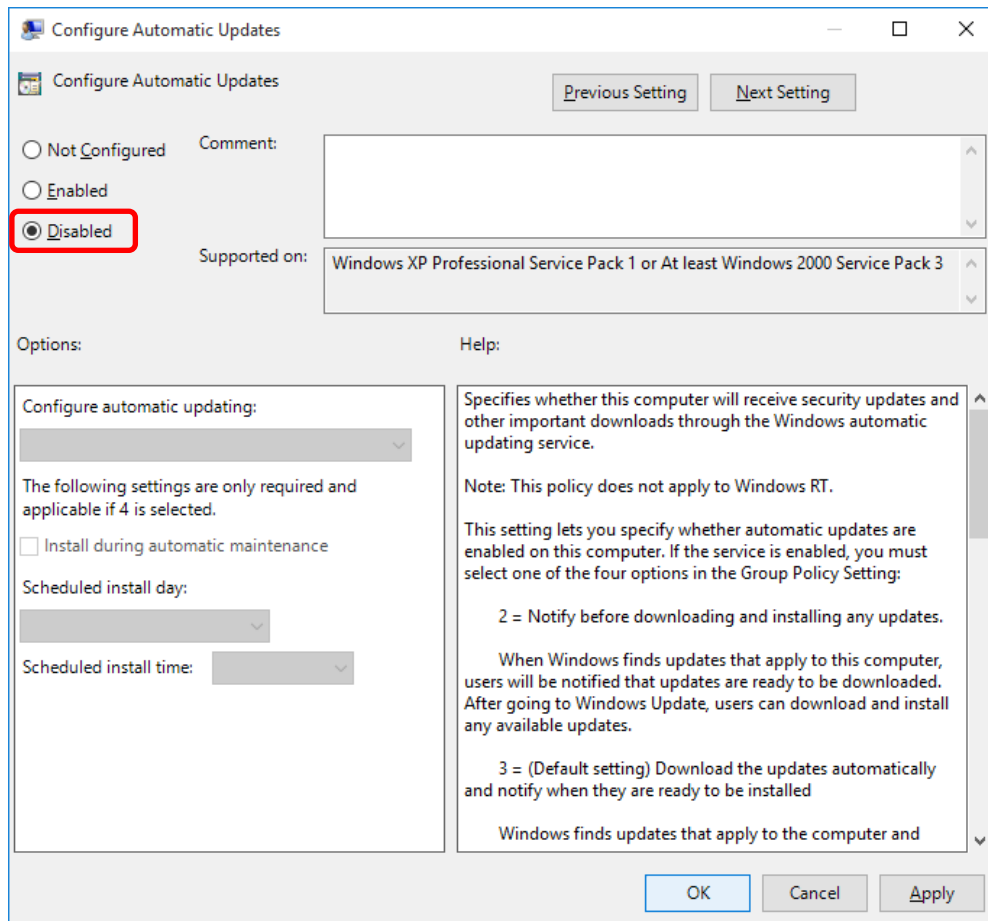

3. SETUP

3.2.1.3 Setting Up display language

The MUI-version Windows® 10 and Windows Server® 2016 can display the language specified from Control Panel by installing an additional language.

[Notice]

- The recovery DVD is required to install an additional language. Before starting this work, prepare the recovery DVD supplied with this equipment.

(1) Installing additional language

Perform the following procedure to install an additional language.

1. After the OS has started, set the last disc (the second one of a set of two discs or the third one of a set of three discs) of the recovery DVD (“HITACHI HJ-7550-WEM* Product Recovery DVD” or “HITACHI HJ-7550-SDM* Product Recovery DVD”) to the DVD drive. (The underlined part is an example. The information of * varies from model to model because the model of the purchased computer is indicated. Replace the model described in the subsequent procedure with the model of the purchased equipment.)
2. Execute the following command from the Command Prompt as administrator.
`dism /online /Add-package /Packagepath:d:language¥zh-cn¥lp.cab`

Notes 1: Specify the DVD drive letter for d: (assuming [D] in the command example).

- 2: Specify the culture name corresponding to the language you want to add for zh-cn. Correspondence between language and culture name is shown below.

Table 3-1 List of Culture names (Windows® 10)

Language	Culture name
Chinese (China)	zh-CN
Korean	ko-Kr
Portuguese	Pt-PT
Thai	th-th
Japanese	ja-jp

3. After the installation has been completed, restart the system.

(2) Switching the language to be displayed

Perform the following procedure to switch the language to be displayed.

1. Open Control Panel, and then click **Add a language**.
2. Click **Add a language**.
3. Select the language you want to display, and then click the **Add** button.
4. Click **Options** of the language you want to display.
5. Click **Make this the primary language** in **Windows display language**.
6. The **Change display language** dialog box appears. In this dialog box, click **Log off now**.
7. After sign in has been completed, reopen Control Panel, and then click **Change date, time, or number formats**.
8. The **Region** window opens. On this window, click the **Administrative** tab.
9. Click **Copy settings...** in **Welcome screen and new user accounts settings**.
10. The **Welcome screen and new user accounts settings** window opens. On this window, select the **Welcome screen and system accounts** checkbox and **New user accounts** checkbox, and then click the **OK** button.
11. The **Change Display Language** dialog box appears. In this dialog box, click the **Restart now** button.
12. After sign in has been completed, reopen Control Panel, and then click **Change date, time, or number formats**.
13. The **Region** window opens. On this window, click the **Administrative** tab.
14. Click **Change system locale...** in **Language for non-Unicode programs**.
15. The **Region Settings** window opens. On this window, set the region, and then click the **OK** button.
16. The **Change System Locale** dialog box appears. In this dialog box, click the **Restart now** button.

Note :The MUI-version Windows® 10 and Windows Server® 2016 switched the display language to Japanese is different from the Japanese-version. Some words are still displayed in English in the application GUI, eventlog message, property of already installed driver.

3. SETUP

(3) Reinstall of updates

Perform the following procedure to reinstall updates

1. Open Control Panel, and then click **Uninstall a program**.
2. The **Programs and Features** window opens. Click **View installed updates**.
3. The **Installed Updates** window opens. On this window, select **Update for Microsoft Windows (KB4016635)**, and then click **Uninstall**.
4. **Uninstall an update** dialog box appears. In this dialog box, click **Yes** button.
5. A dialog box "Please wait while the updates..." is displayed to indicate that updates are being uninstalled.
6. After uninstal has been completed, a window is displayed to indicate restart. On this window, click **Restart Now** button.
7. After the OS has started, set the first disc of the recovery DVD ("HITACHI HJ-7550-WEM* Product Recovery DVD" or "HITACHI HJ-7550-SDM* Product Recovery DVD") to the DVD drive.
8. Execute the following command from the Command Prompt as administrator.
`D:¥WindowsUpdates¥AMD64-all-windows10.0-kb4016635-x64_2b1b48aa6ec51c019187f15059b768b1638a21ab.msu`
9. A dialog box "Preparing the installation..." is displayed.
10. **Windows Update Standalone Installer** window opnes. In this window click **Yes** button.
11. A dialog box "Copying packages to the Windows Update cache ..." is displayed.
12. **Download and Install Updates** window opens.
13. After install has been completed, a window is displayed to indicate restart. Remove the recovery DVD from the DVD drive, and click the **Restart Now** button.

3.2.2 Basic Settings for Windows® 7

This section describes the basic settings procedure of the preinstalled Windows® 7 Professional.

Perform this procedure as needed after the setup of OS according to “3.1 Setup Procedure When You Turn On the Power for the First Time”.

3.2.1.1 Outline of basic settings procedure

Setting up the network environment	➔	See “2.8 Setting Up the LAN Interface” .
Setting up the screen	➔	See “2.9 Setting Up the Screen” .
Setting up auto-update	➔	See “3.2.2.2 Setting Up Auto-update” . • The procedure takes about 5 minutes.
Only when using the Internet Explorer 11		
Internet Explorer 11 setup procedure	➔	See “3.2.2.3 Internet Explorer 11 setup procedure” .

3. SETUP

3.2.2.2 Setting Up Auto-update

Windows® 7 has an automatic updating function for bug fixes. This function automatically downloads and installs bug fix updates released on the Microsoft Web site.

The following procedure shows how to turn off automatic updating.

1. If you are not logged on to the computer as an administrator account, log on to the computer as an administrator account.
2. Click **Start** and then click **Control Panel**.
3. The **Control Panel** window opens. Click **System and Security**.
4. Then click **Turn automatic updating on or off** under **Windows Update**.

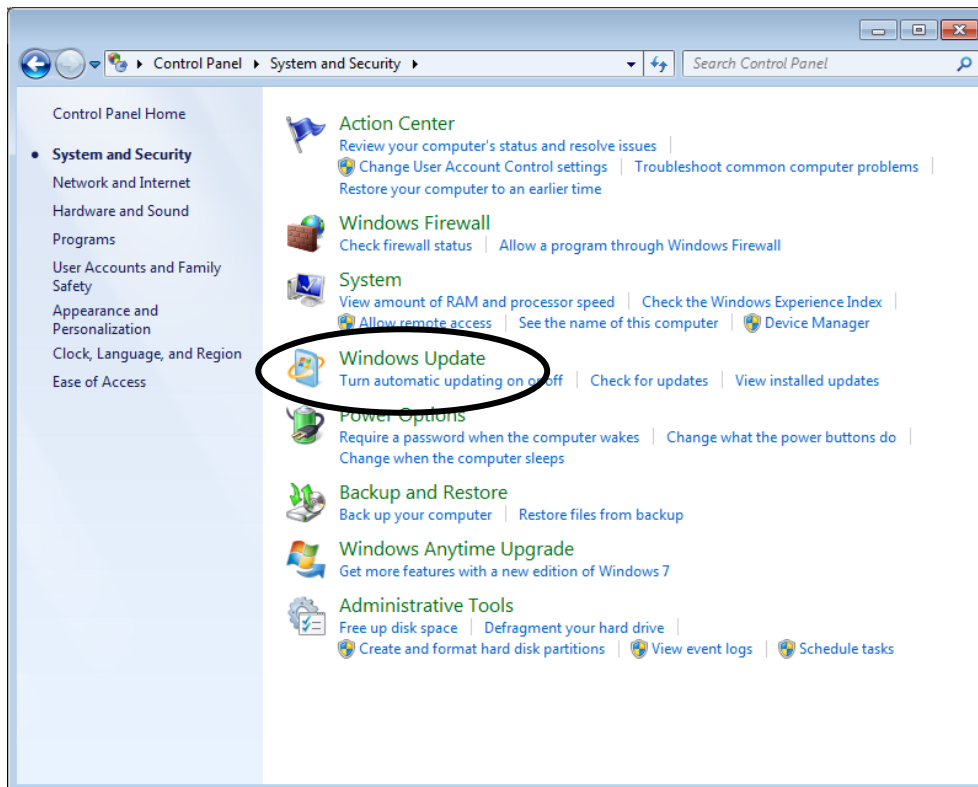

5. The **Choose how Windows can install updates** window is displayed. Select **Never check for updates (not recommended)** and click **OK**.

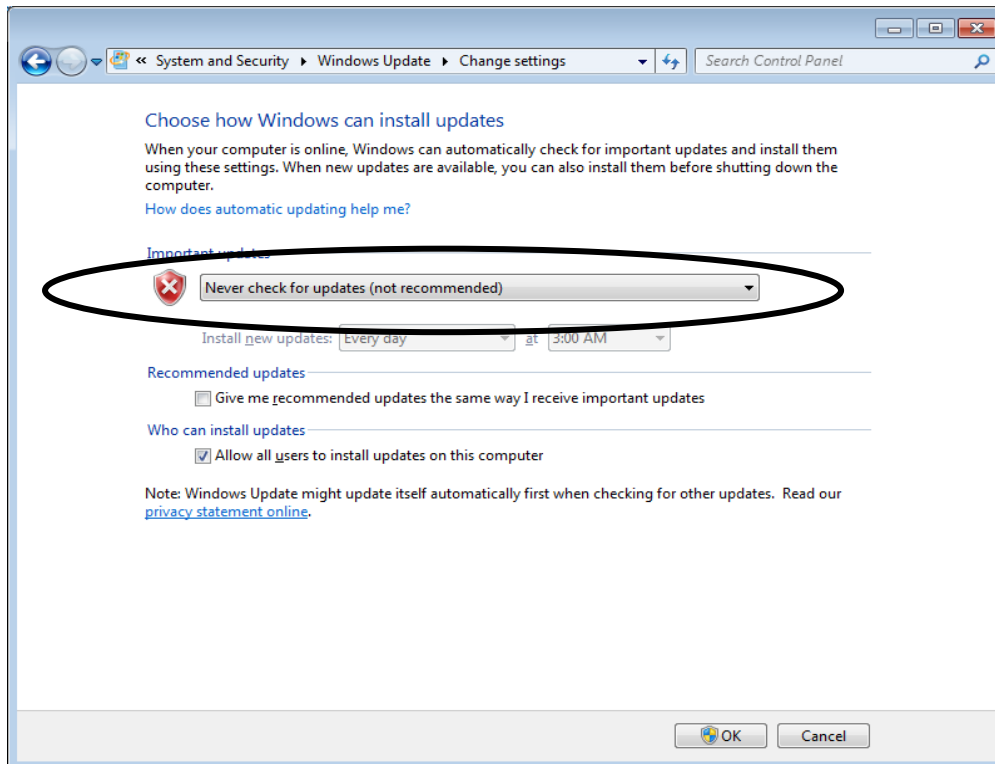

6. Click the **Close** button [×] at the upper right corner of the **System and Security** window.

3. SETUP

3.2.2.3 Internet Explorer 11 setup procedure

To ensure the compatibility with the conventional model, Internet Explorer 8 is still installed in Windows® 7 models at shipping. Microsoft support for Internet Explorer 8 in Windows® 7 has been discontinued on January 12, 2016. Therefore, perform the following procedure to upgrade Internet Explorer 8 to Internet Explorer 11.

1. If you have not logged on with the computer's administrator account, log on to the computer with the computer's administrator account.
2. Close all running applications.
3. Activate the command prompt of administrator authority.
 - Click **Start** and point to **All Programs**.
 - Click **Accessories**.
 - Right-click **Command Prompt** to show a menu. On the menu, click **Run as administrator**.
(If the administrator account you used for log on is a built-in administrator account, simply click **Command Prompt**.)
 - If you see the **User Account Control** window, click **Yes**.
4. Type the following character string in the command prompt, and then press the **Enter** key.
C:\¥HITACHI¥IE11¥Preparation.bat
5. The following message appears and installation of the update program necessary for installing Internet Explorer 11 starts.
Please wait.
Installing Windows Update for IE11: 1 of 4. (This message is displayed until "4 of 4" is shown.)
6. When the update program has been installed, the following message appears to prompt restart. Enter **y** to restart the system.
Please restart system.
Are you sure you want to restart now?[y/n]
7. After the system has restarted, activate the command prompt of administrator authority again, and then type the following character string.
C:\¥HITACHI¥IE11¥INSTALLERS¥EN-US¥IE11-WINDOWS6.1-X86-EN-US.EXE

Notes 1: Specify the culture name corresponding to the language you want to add for EN-US. Correspondence between language and culture name is shown below.

Table 3-2 List of Culture names (Internet Explorer 11)

Language	Culture name
Japanese	JA-JP
English	EN-US
Chinese (China)	ZH-CN
Chinese (Hong Kong)	ZH-hk
Chinese (Taiwan)	ZH-tw
Korean	KO-Kr
Portuguese	PT-PT
Thai	TH-th

Notes 2: Type “X86” for 32-bit OS or “X64” for 64-bit OS in X86.

8. The following window opens. On this window, click **Install**.

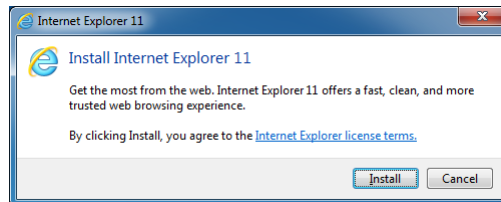

9. The following window opens. On this window, click **Continue**. Installation of Internet Explorer 11 starts.

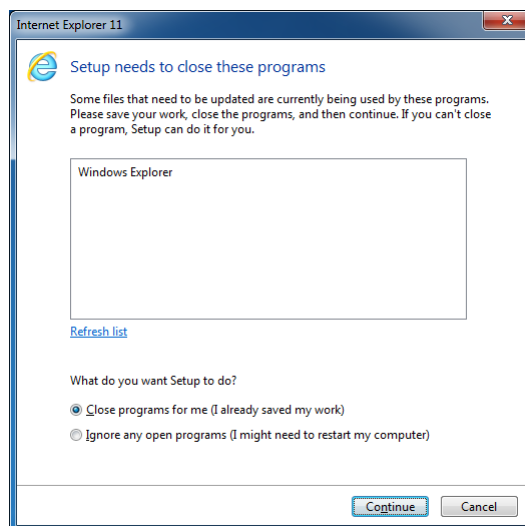

3. SETUP

10. When the installation has been completed, the following window opens.

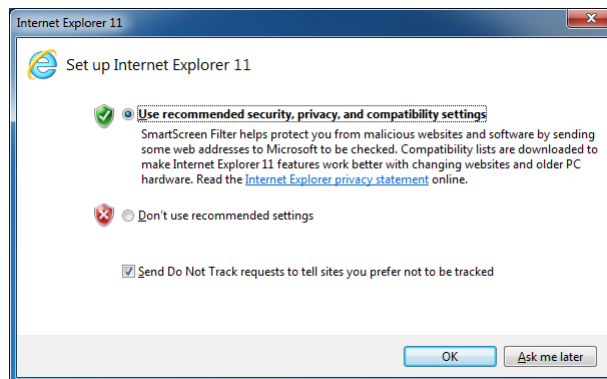

11. Perform the Internet Explorer setting following the instruction in the window.

< NOTE >

- If the installation failed, visit the following site to solve the problem.

Microsoft technical information document number 2872074
Troubleshooting a failed installation of Internet Explorer 11
<https://support.microsoft.com/en-us/kb/2872074>

3.2.3 Setup Procedure when using Windows XP Mode

This section describes the setup procedure when Windows XP Mode is used. Follow this setup procedure only if you use Windows XP Mode and after you read the following notes carefully.

< NOTE >

- A virtual environment with license authenticated Windows® XP installed is contained in this product as Windows XP Mode.
- Windows XP Mode is a feature intended for running Windows® XP applications that cannot run in Windows® 7. This feature must be used as a last resort to maintain compatibility for applications. Use this feature only if you cannot resolve the compatibility issue of an application in any other ways.
- It is not guaranteed that all Windows® XP applications can run in Windows XP Mode.
- When using Windows XP Mode, install the main memory card that satisfies the following sizes:
If the OS is a 32-bit version: 2 GB or more
If the OS is a 64-bit version: 3 GB or more
- Windows® 7 comes with the Multilingual User Interface (MUI) for the host OS, but Windows XP Mode can only provide an English version of Windows® XP.

< If Windows XP Mode is not used >

The files used for setting up Windows XP Mode include a virtual hard disk file for the guest OS and therefore occupy about 700 MB of disk space. If Windows XP Mode is not used, we recommend that you follow the procedure below to delete the directory storing those files.

1. If you are not logged on to the computer as an administrator account, log on to the computer as an administrator account.
2. Start the command prompt.
 - Click **Start** and point to **All Programs**.
 - Click **Accessories**.
 - Right-click **Command Prompt** to show a menu. On the menu, click **Run as administrator**.
(If the administrator account you used for log on is a built-in administrator account, simply click **Command Prompt**.)
 - If you see the **User Account Control** window, click **Yes**.
3. At the command prompt, type the following and press **Enter**.
`rmdir /s C:¥HITACHI¥XP_Mode`
4. A confirmation message for the deleting directory is output. Type **y** and then press **Enter**.

3. SETUP

3.2.3.1 Overview of the setup procedure

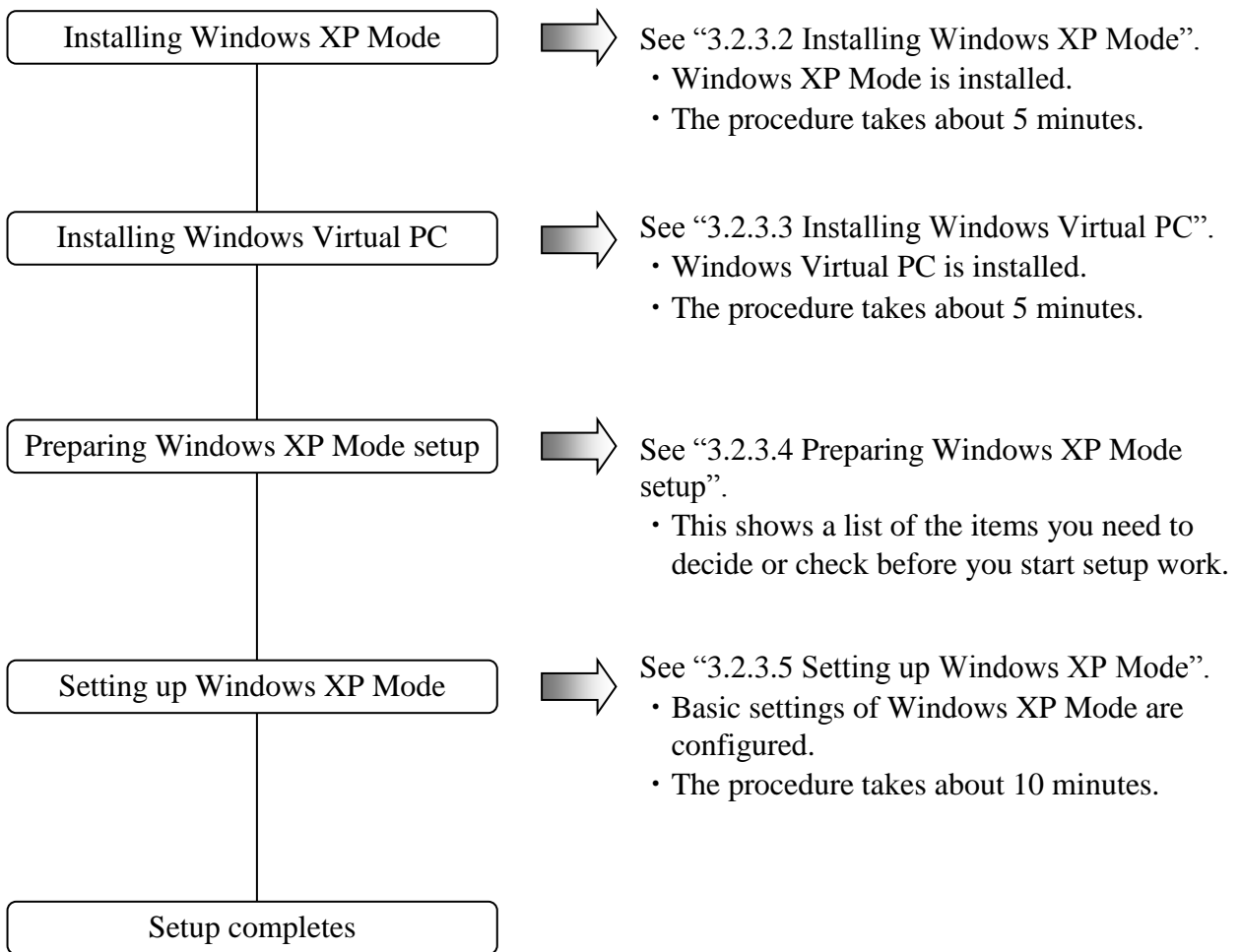

For information about how to delete Windows XP Mode and Windows Virtual PC from the computer, see “3.2.3.6 Uninstalling Windows XP Mode and Windows Virtual PC” .

< NOTE >

- Windows XP Mode requires Windows Virtual PC to be installed in order to run Microsoft® Windows® XP Professional SP3 on the virtual machine.
- End users are responsible for installing Windows XP Mode and Windows Virtual PC. Alternatively, the personnel in charge of constructing the system can do the installation work in behalf of the end users.

3.2.3.2 Installing Windows XP Mode

Follow the procedure below to install Windows XP Mode:

1. If you are not logged on to the computer as an administrator account, log on to the computer as an administrator account.

2. Start the command prompt to start an installation program.

- Click **Start** and point to **All Programs**.
- Click **Accessories**.
- Right-click **Command Prompt** to show a menu. On the menu, click **Run as administrator**.

(If the administrator account you used for log on is a built-in administrator account, simply click **Command Prompt**.)

- If you see the **User Account Control** window, click **Yes**.

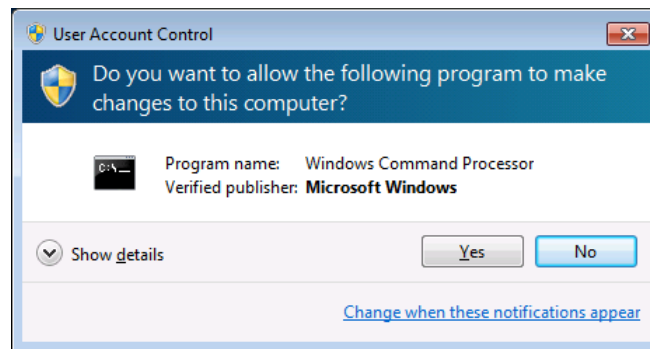

3. At the command prompt, type the following and press **Enter**.

```
cd C:¥HITACHI¥XP_Mode
```

4. And then type the following and press **Enter**. Installation starts.

```
WXPMode_install.bat
```

5. When the installation finishes, the following message is displayed to indicate the installation is complete.

```
Installation completed.
```

This completes the installation procedure. Close the command prompt.

3. SETUP

3.2.3.3 Setting up Windows Virtual PC

Follow the procedure below to install Windows Virtual PC.

1. If you are not logged on to the computer as an administrator account, log on to the computer as an administrator account.
2. Start a setup program.
 - Click **Start**. In the **Search programs and files** box at the lower left corner on the Start menu, type the following, and then press **Enter**.

C:\HITACHI\XP_Mode\Virtual-PC

- The Windows Explorer window is displayed. Double-click a setup program under the directory.

Windows6.1-KB958559-x64.msu

3. The **Windows Update Standalone Installer** window opens. Click **Yes**.

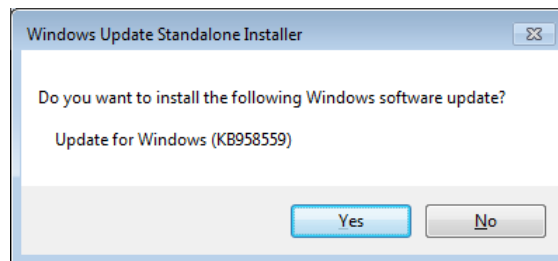

4. The **Download and Install Updates** window opens. Read the license terms carefully, and then click **I Accept**. Installation starts.

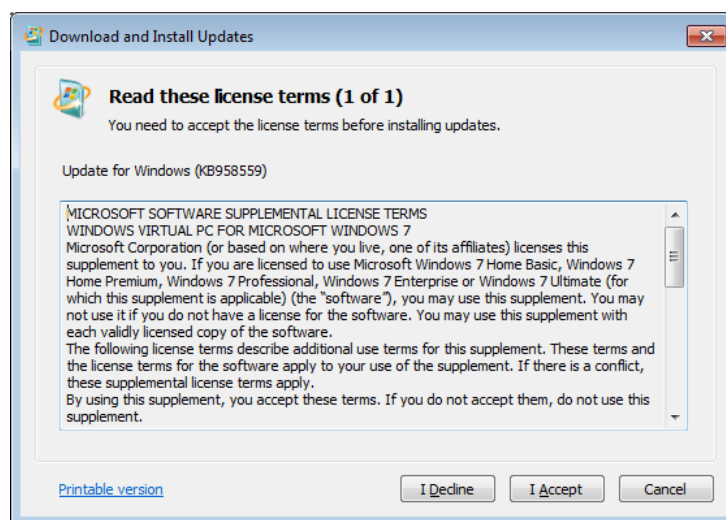

5. After the installation is complete, a window is displayed to prompt you to restart the system. Click **Restart Now** to restart. Restart begins.

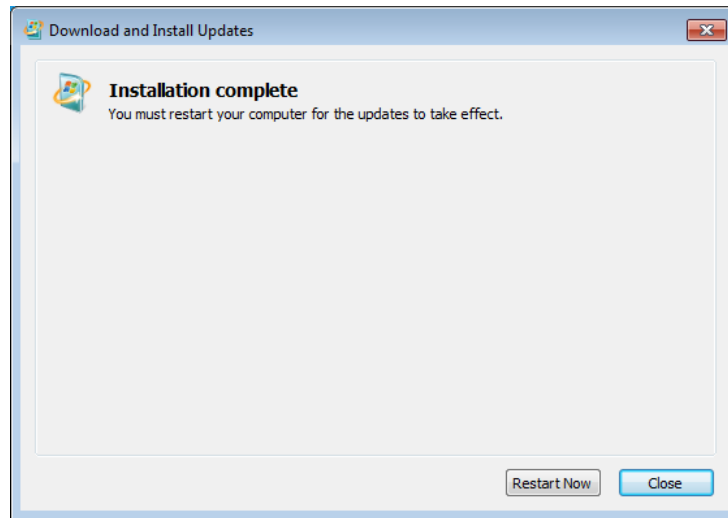

3.2.3.4 Preparing Windows XP Mode setup

The following items are necessary for the setup work for Windows XP Mode. Before you start the setup work, decide or check those items beforehand.

Item	Description
Password for XPMUser	A password for XPMUser (administrator account of the computer) You can change the setting after the setup.

3. SETUP

3.2.3.5 Setting up Windows XP Mode setup

Follow the procedure below to set up Windows XP Mode.

1. Click **Start** and point to **All Programs**.
2. Click **Windows Virtual PC > Windows XP Mode**.

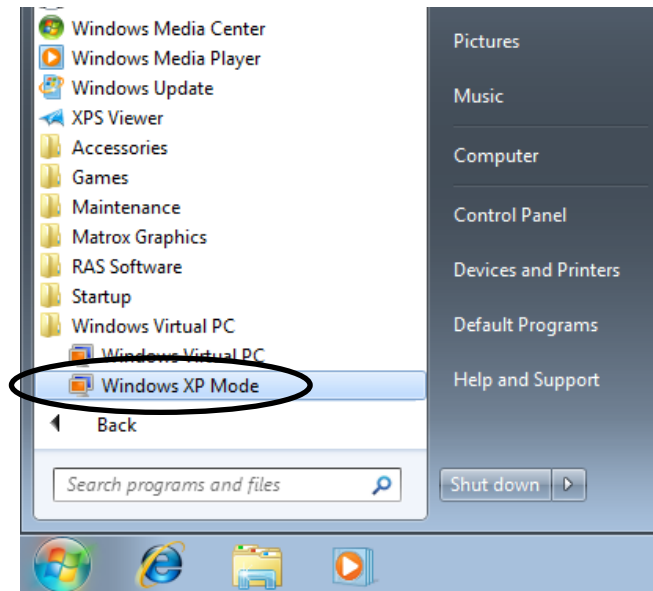

3. The Windows XP Mode License Agreement is displayed.

- Read the license agreement carefully and select the **I accept the license terms** check box. Click **Next**.



4. The **Installation folder and credentials** window opens.

- In the **Password** and **Confirm password** boxes, type a password for XPMUser.
- Click **Next**.

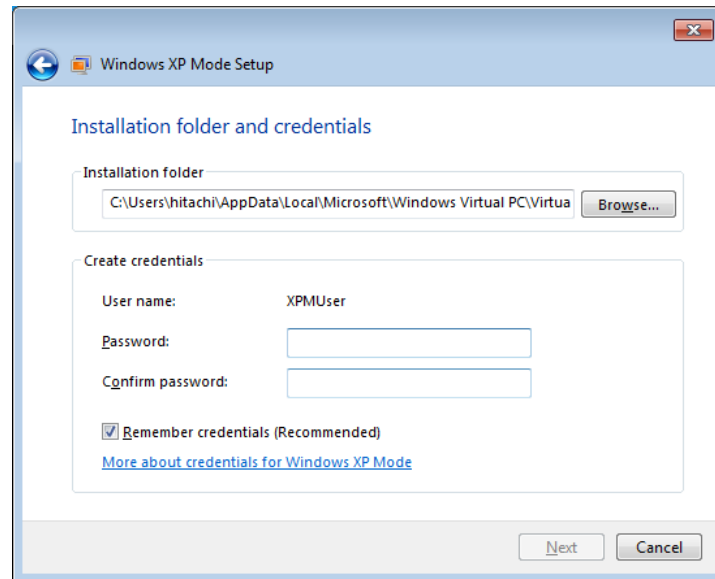

5. A window for configuring Automatic Updates is displayed.

- Select **Not right now** and click **Next**.

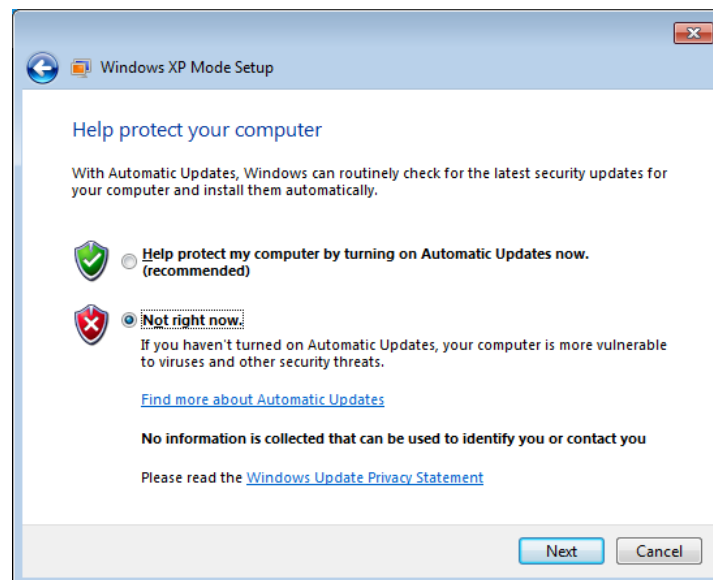

3. SETUP

6. A window is displayed to indicate setup will share the drives.

- Click **Start Setup**.

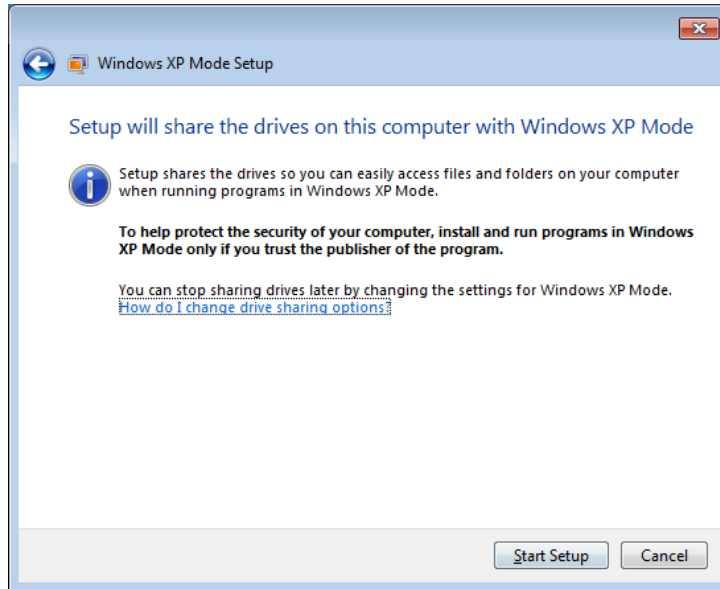

7. A window is displayed to show the Windows XP Mode setup is progressing.



When the setup is complete, the virtual machine is started and you are automatically logged on as an XPMUser.

The following event may be recorded in the event log after the first logon. The operation of the system will not be affected.

Source: Service Control Manager

Event ID: 7005

Type: Error

< NOTE >

- When Windows XP Mode is started for the first time after the setup, you may find the time zone of Windows XP Mode is not the same as the time zone of Windows® 7. If this happens, you need to manually change the time zone of Windows XP Mode so that they are the same.

3. SETUP

3.2.3.6 Uninstalling Windows XP Mode and Windows Virtual PC

When you delete Windows XP Mode and Windows Virtual PC from the computer, follow the procedure described in this section to uninstall those two.

< NOTE >

- If any application programs are running, exit all application programs before you start uninstallation.

(a) Uninstalling Windows XP Mode

Follow the procedure below to uninstall Windows XP Mode.

1. If you are not logged on to the computer as an administrator account, log on to the computer as an administrator account.

2. Start Command Prompt to launch an uninstallation program.

- Click **Start** and point to **All Programs**.
- Click **Accessories**.
- Right-click **Command Prompt** to show a menu. On the menu, click **Run as administrator**.

(If the administrator account you used for log on is a built-in administrator account, simply click **Command Prompt**.)

- If you see the **User Account Control** window, click **Yes**.

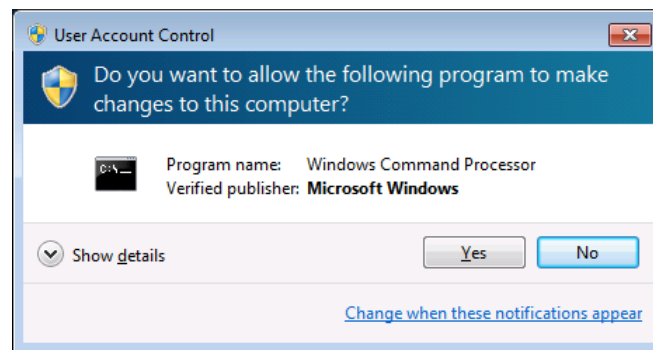

3. At the command prompt, type the following and press **Enter**.

```
cd "C:¥HITACHI¥XP_Mode¥Windows XP Mode"
```

4. And then type the following and press **Enter**.

```
WXPMoDe_uninst.bat
```

5. At the beginning of the uninstallation, the “Do you want to uninstall Windows XP Mode? (y/n)” message is displayed.

If you want to uninstall, press **y** and press **Enter**.

If you do not want to uninstall, press **n**, and press **Enter**. The uninstallation will be aborted.

6. When the uninstallation finishes, the following message is displayed to indicate the uninstallation is complete:

Uninstallation completed.

This completes the uninstallation procedure for Windows XP Mode. Close the command prompt, and then uninstall Windows Virtual PC.

3. SETUP

(b) Uninstalling Windows Virtual PC

Follow the procedure below to uninstall Windows Virtual PC.

1. If you are not logged on to the computer as an administrator account, log on to the computer as an administrator account.
2. Click **Start** and then click **Control Panel**.
3. Click **Programs**.
4. Under **Programs and Features**, click **View installed updates**.

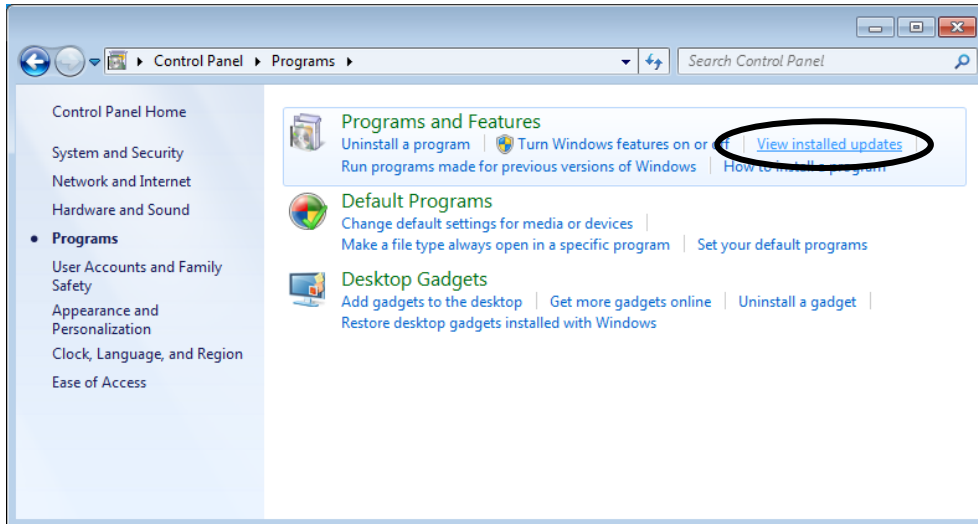

5. The **Installed Updates** window opens. From the list, select **Windows Virtual PC (KB958559)** and then click **Uninstall**.

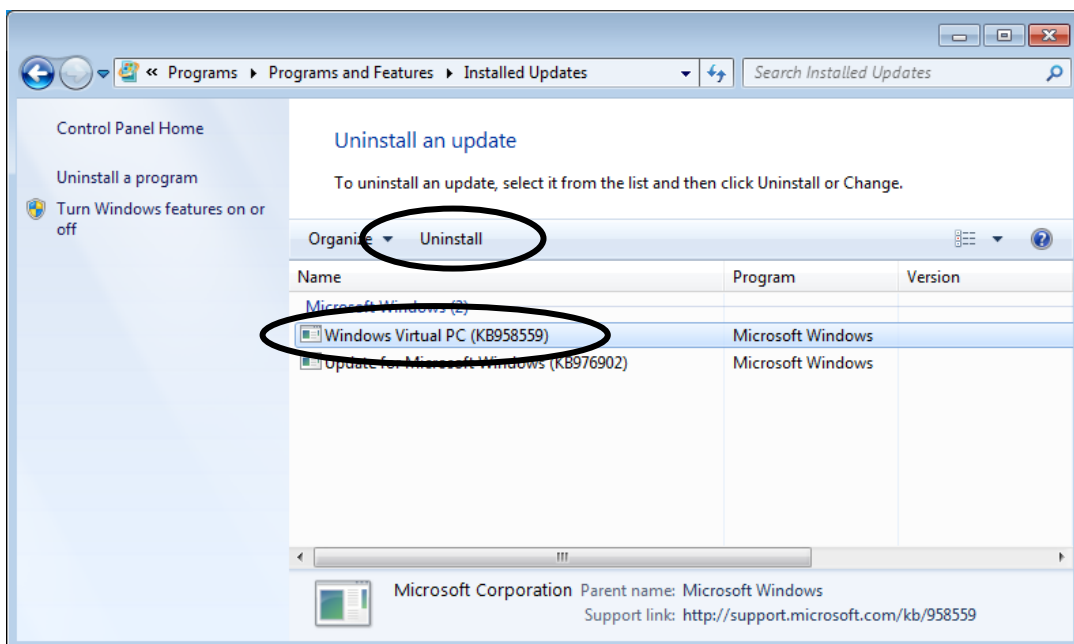

6. The **Uninstall an update** window is displayed. Click **Yes**.

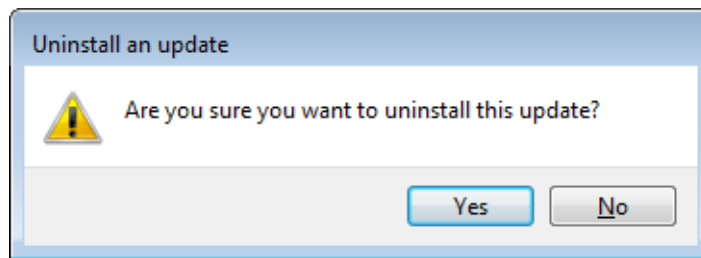

7. After the installation is complete, a window is displayed to prompt you to restart the system. Click **Restart Now** to restart.

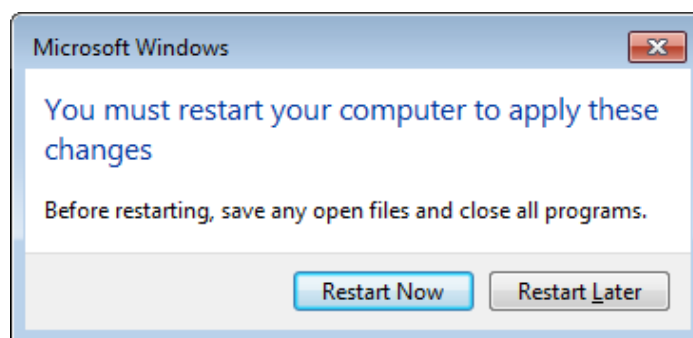

This completes the uninstallation procedure for Windows Virtual PC.

< NOTE >

- When you want to reinstall Windows XP Mode, follow “3.2.3.2 Installing Windows XP Mode” and “3.2.3.5 Setting up Windows XP Mode”. You may see the following dialog box during Windows XP Mode setup. In this case, click **Create New** to continue the setup process.

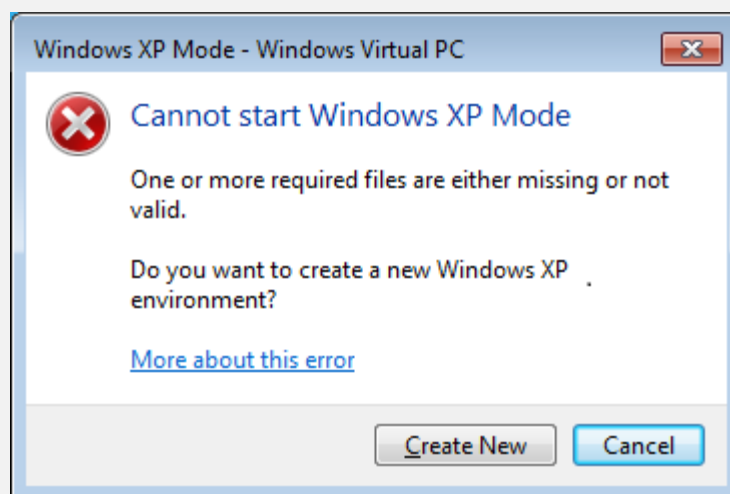

This Page Intentionally Left Blank

CHAPTER 4 PRECAUTIONS WHILE THE OS IS RUNNING

4.1 Event Log Entries during Setup

This equipment may record the following events in the event log during the OS setup, but those events do not affect the operation of the system.

Table 4-1 Error / Warning Event Log (During the OS setup)

Source	Event ID	Type
Search-ProfileNotify	2	Error
Security Center	16	Error
volmgr	49	Error
Service Control Manager	7000, 7009, 7022, 7023, 7024, 7043	Error
Bits-Client	16392	Error
Search	1008	Warning
e1repress	27	Warning
Kernel-PnP	219	Warning
User Profiles Service	1534	Warning

Event ID: 7009 and 7023 may be recorded in the event log during the OS setup and other situation, but these event IDs do not represent any problem if not recorded intermittently.

4. PRECAUTIONS WHILE THE OS IS RUNNING

4.2 Event Log Entries While the OS is Running

- In the case of Windows® 10 and Windows Server® 2016

This equipment may record the following events in the event log while the OS is running, but those events do not affect the operation of the system.

Table 4-2 Error / Warning Event Log (While Windows® 10 and Windows Server® 2016 are running) (1/2)

Source	Event ID	Type
DistributedCOM	10010	Error
Search	3104	Error
Security-SPP	1014, 8198, 8200	Error
Time-Service	134	Warning
Search	3036	Warning
Windows Remote Management	10149	Warning

This equipment may record the following events in the event log while the OS is running,

Table 4-3 Error / Warning Event Log (While Windows® 10 and Windows Server® 2016 are running) (2/2)

Source	Event ID	Type
DistributedCOM	10016	Error
CD-ROM	51	Error
atapi	11	Error

- Source: DistributedCOM, Event ID: 10016 is no problem as long as the content of the event log corresponds to the following.

< Contents of event log >

The application-specific permission settings do not grant Local Activation permission for the COM Server application with CLSID {*****} and APPID {*****} to the user NT AUTHORITY\SYSTEM ID (S-1-5-18) from address LocalHost (Using LRPC) running in the application container Unavailable SID (Unavailable). This security permission can be modified using the Component Services administrative tool.

Please confirm that CLSID and APPID recorded in event log are as follows.

CLSID	D63B10C5-BB46-4990-A94F-E40B9D520160
APPID	9CA88EE3-ACB7-47C8-AFC4-AB702511C276

CLSID	260EB9DE-5CBE-4BFF-A99A-3710AF55BF1E
APPID	260EB9DE-5CBE-4BFF-A99A-3710AF55BF1E

- Source:CD-ROM, Event ID:51 event may be recorded in the event log. As long as you can access the DVD drive, there is no problem.
- Source:atapi, Event ID: 11 event may be recorded even if errors occurred in reading from the drive and the error recovery was successful after reading normally from the other drive.

If the error is recovered, an error log occurs once. If it happens multiple times consecutively within 1 to 2 minutes, there is a possibility that the error recovery has failed.

4. PRECAUTIONS WHILE THE OS IS RUNNING

- In the case of Windows® 7

This equipment may record the following events in the event log while the OS is running, but those events do not affect the operation of the system.

Table 4-4 Error / Warning Event Log (While Windows® 7 is running) (1/2)

Source	Event ID	Type
DistributedCOM	10010	Error
WMI	10	Error
User Profile Service	1530	Warning
elrepress	27	Warning

This equipment may record the following events in the event log while the OS is running

Table 4-5 Error / Warning Event Log (While Windows® 7 is running) (2/2)

Source	Event ID	Type
Disk	11	Error
CR-ROM	51	Error
atapi	11	Error

- Source:Disk, Event ID:11 event may be recorded in the event log when a USB device is connected or disconnected or when the system starts for the first time after a storage device is added, even though the USB device or the storage device works without any problems. Those events are recorded due to the specifications of the OS and do not affect the operation of the system.

For details, see the following website.

Microsoft technical information Document number : 2537729

Disk event ID11 may be recorded when you connect USB flash memories or USB disks to a computer on which Windows 7 or Windows Server 2008 R2 is installed.

<https://support.microsoft.com/ja-jp/kb/2537729>

- Source:CD-ROM, Event ID:51 event may be recorded in the event log. As long as you can access the DVD drive, there is no problem.
- Source:atapi, Event ID: 11 event may be recorded even if errors occurred in reading from the drive and the error recovery was successful after reading normally from the other drive.
If the error is recovered, an error log occurs once. If it happens multiple times consecutively within 1 to 2 minutes, there is a possibility that the error recovery has failed.

4. PRECAUTIONS WHILE THE OS IS RUNNING

4.3 Scheduled Functions by Default

In Windows®, various functions are scheduled by default and executed periodically in the background. Among those functions, Windows Defender (anti-spyware feature) and the disk defragmenter (or optimize drives) may increase the system load significantly when they run and may affect the operation of the applications for business use.

(2) Drive Optimize (for Windows® 10)

On this equipment, the drive optimization schedule is turned off by default. If you want to optimize drives, you can do that by using either one of the methods below.

- (a) Turn on the drive optimization schedule.
- (b) Run the drive optimization manually.

The procedure of each method is described below.

(a) Turn on the drive optimization schedule.

1. Sign in to the computer as an administrator and display the **Control Panel** windows.
2. Click **System and Security**.
3. Under **Administrative Tools**, click **Defragment and optimize your drives**.

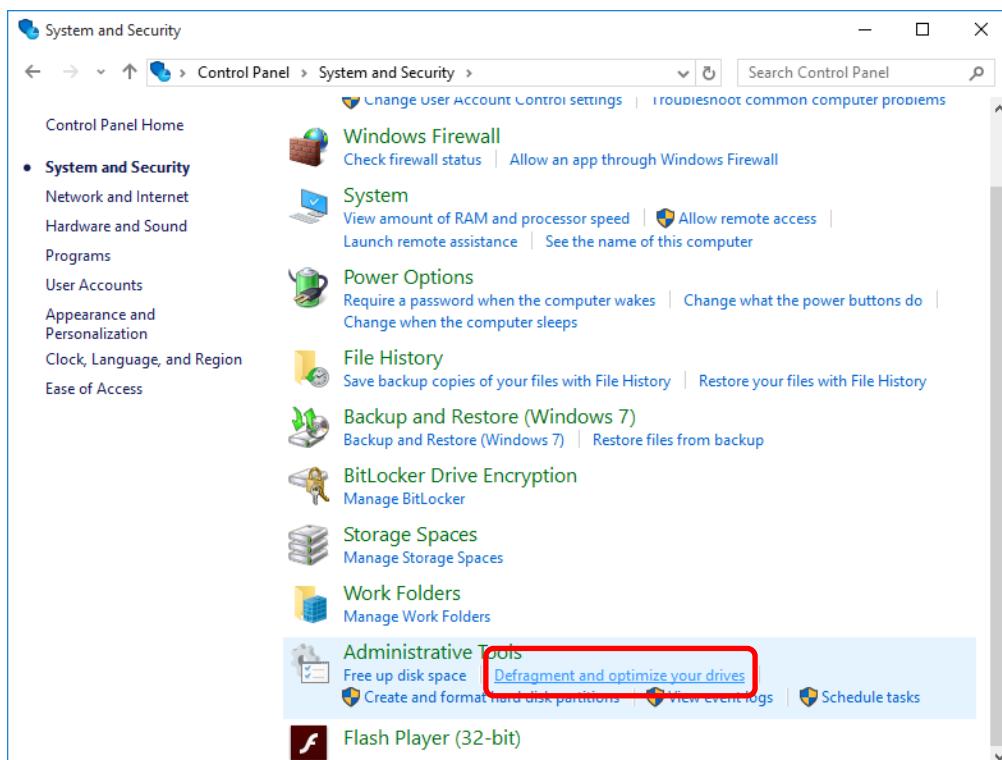

4. The **Optimize Drives** window appears.

- Under **Scheduled optimization**, click **Turn on**.

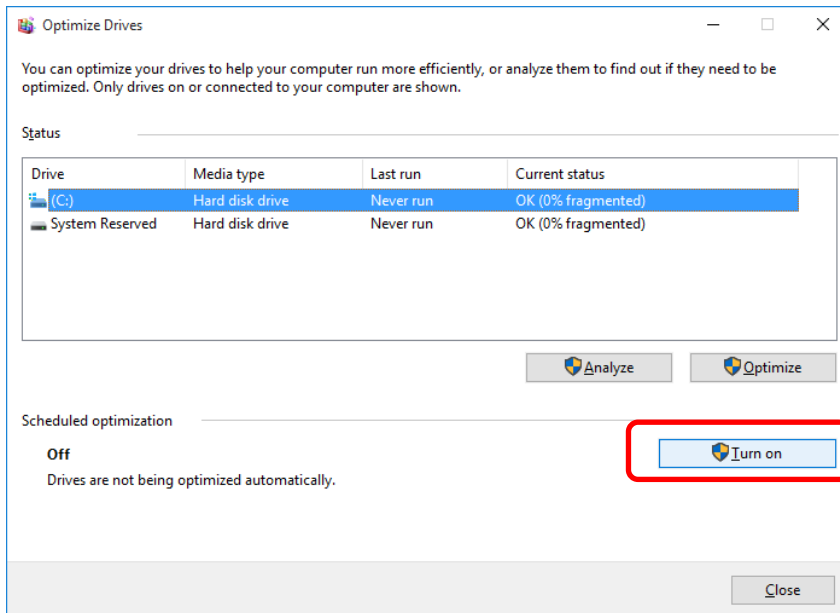

5. The **Optimization schedule** window appears. Select the **Run on a schedule (recommended)** check box.

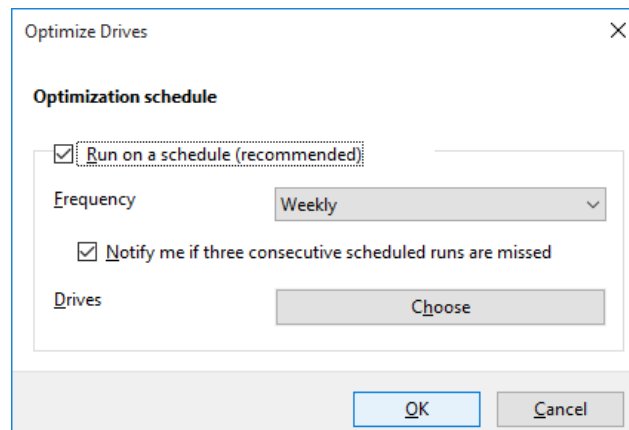

6. As required, configure the frequency of defragmentation. The initial schedule of defragmentation is as follows.

- Frequency: Weekly

7. Click **Choose**.

4. PRECAUTIONS WHILE THE OS IS RUNNING

8. The **Select the drives you want to optimize on a regular schedule** window appears.

As required, select the drives you want to defragment.

- Click **OK**.

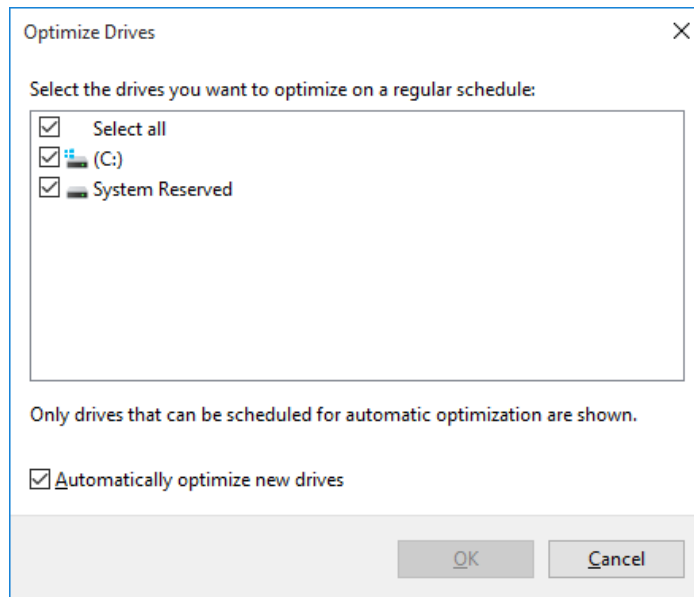

9. The **Optimization schedule** window appears. Click **OK**.

10. The configured schedules are displayed under **Scheduled optimization**. Check the contents, and click **Close** to close the window.

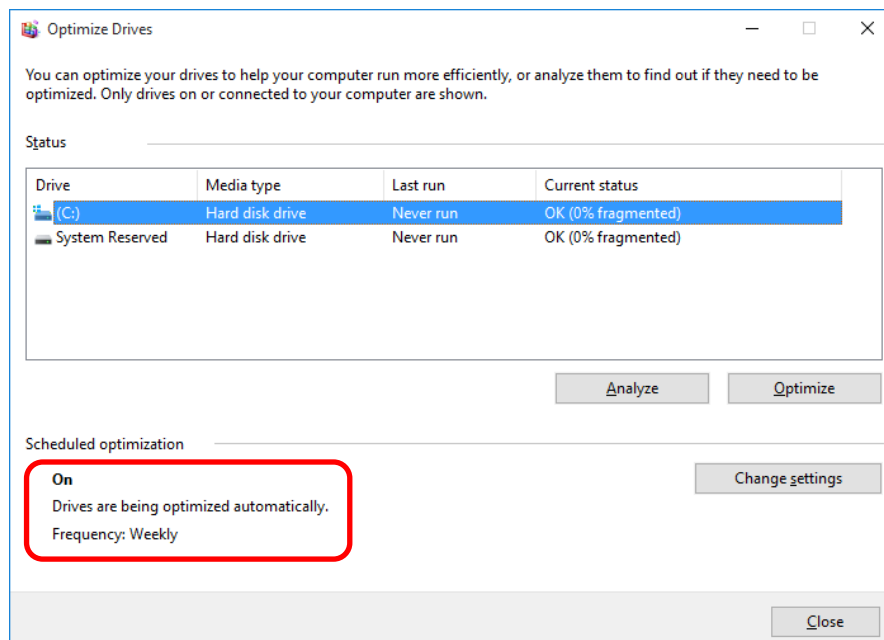

(b) Run the drive optimization manually.

1. Execute steps 1 through 3 in ” (a) Turn on the drive optimization schedule.”
2. The **Optimize Drives** window appears.
 - Under **Status**, select the drive you want to defragment, and click **Optimize**.

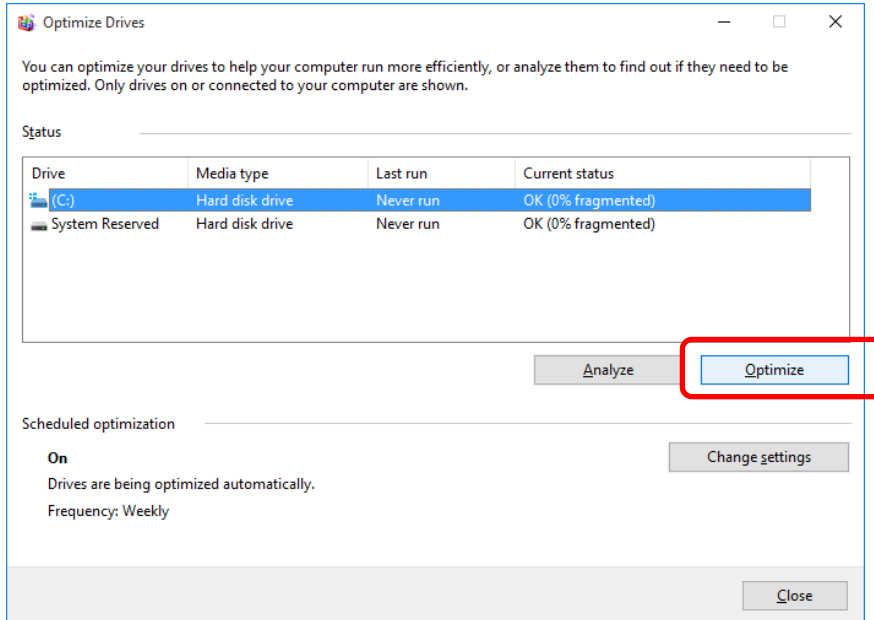

- When the disk optimization process is complete, the date and time of the optimization is displayed in the **Last Run** column.

3. Click **Close** to close the window.

4. PRECAUTIONS WHILE THE OS IS RUNNING

(2) Disk Defragmenter (for Windows® 7)

On this equipment, scheduled defragmentation by Disk Defragmenter is turned off. If you want to defragment disks by using Disk Defragmenter, you can do that by using either one of the methods below.

- (a) Turn on scheduled defragmentation by Disk Defragmenter.
- (b) Run Disk Defragmenter manually.

The procedure of each method is described below.

(a) Turn on scheduled defragmentation by Disk Defragmenter.

1. If you are not logged on to the computer as an administrator, log on to the computer as an administrator.
2. Click **Start > Control Panel**.
3. The **Control Panel** window appears. Click **System and Security**
4. Under **Administrative Tools**, click **Defragment your hard drive**.

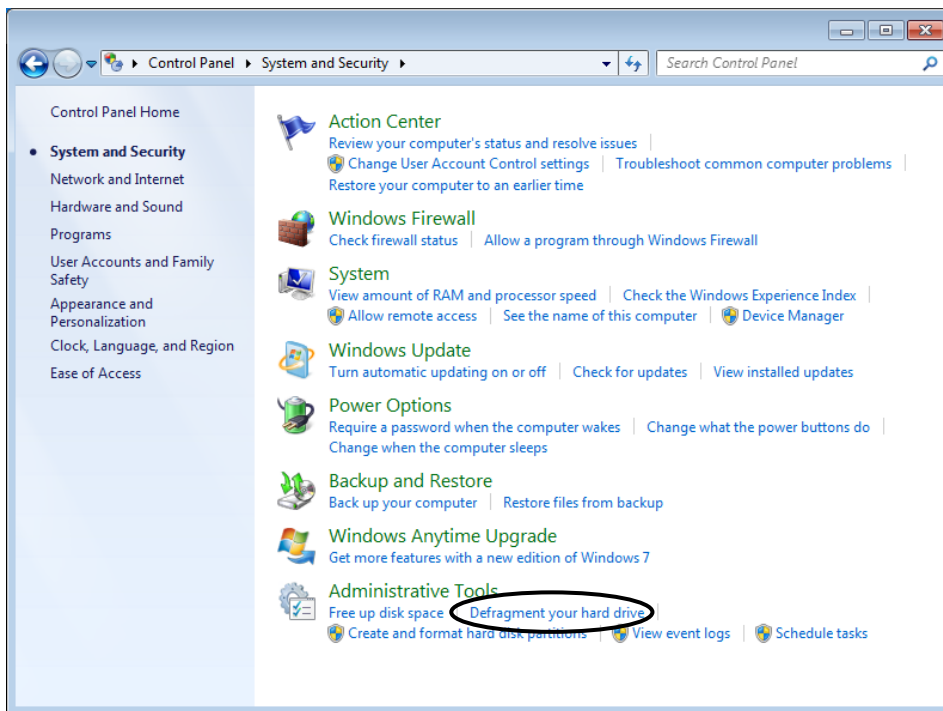

4. PRECAUTIONS WHILE THE OS IS RUNNING

- The following window is displayed when you select the Disk Defragmenter tool for the first time. Then click **Remove settings**.

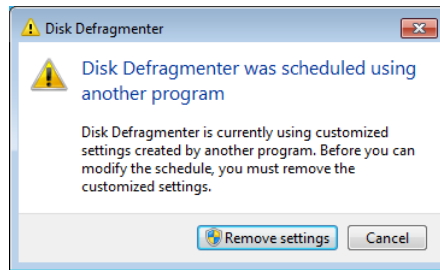

5. The **Disk Defragmenter** window appears.

- Under **Schedule**, click **Turn on schedule**.

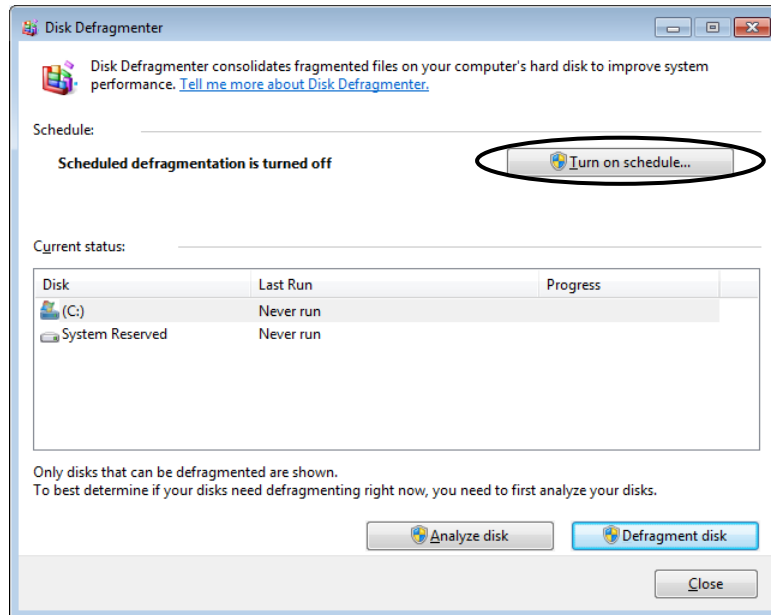

6. The **Disk Defragmenter: Modify Schedule** window appears. Select the **Run on a schedule (recommended)** check box.

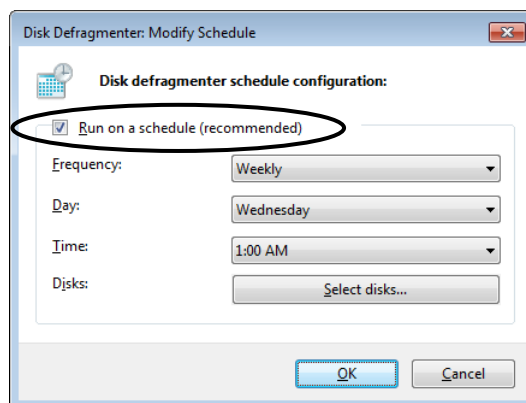

4. PRECAUTIONS WHILE THE OS IS RUNNING

7. As required, configure the frequency, day of the week, and start time of defragmentation. We recommend the scheduled times of defragmentation you configure do not conflict with the schedule of the applications for business use. The initial schedule of defragmentation is as follows.

- Frequency: Weekly
- Day of the week: Wednesday
- Start time: 1:00

8. Click **Select disks**.

9. The **Disk Defragmenter: Select Disks For Schedule** window appears. As required, select the drives you want to defragment.

- Click **OK**.

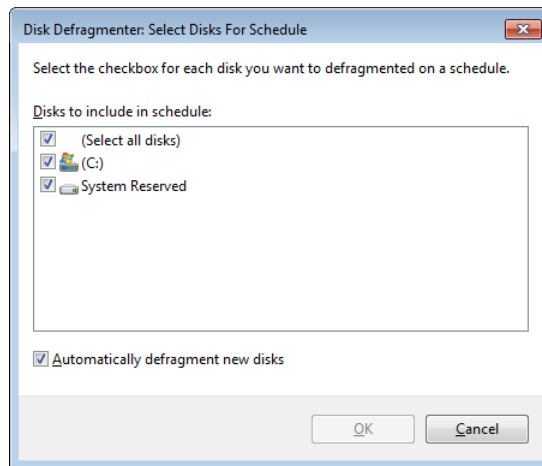

Note 1: SSDs do not appear in the **Select Disks For Schedule** window.

10. The **Disk Defragmenter: Modify Schedule** window appears. Click **OK**.

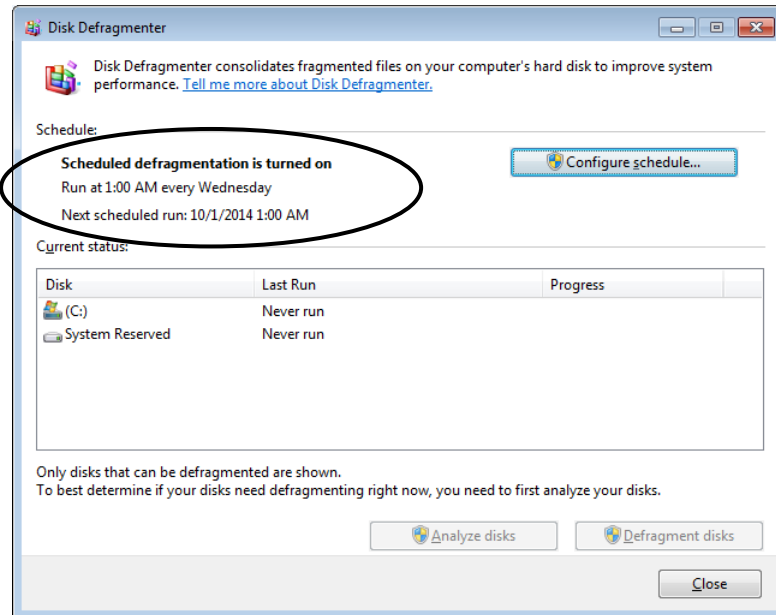

11. The configured schedules are displayed under **Schedule**. Check the contents, and click **Close** to close the window.

4. PRECAUTIONS WHILE THE OS IS RUNNING

(b) Run Disk Defragmenter manually.

1. If you are not logged on to the computer as an administrator, log on to the computer as an administrator.
2. Click **Start > Control Panel**.
3. The **Control Panel** window appears. Click **System and Security**.
4. Under **Administrative Tools**, click **Defragment your hard drive**
 - The following windows is displayed when you select the Disk Defragmenter tool for the first time. Then click **Remove settings**. (After you finish the procedure above, disk defragmenter schedule is disabled. If you want to disable disk defragmenter schedule after running disk defragment, proceed to step 7.

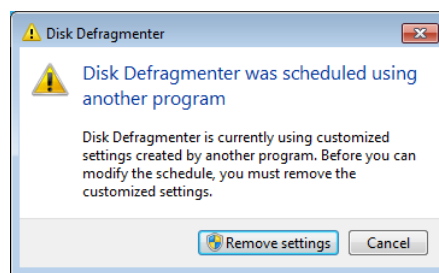

5. The **Disk Defragmenter** window appears.

- Under **Current status**, select the drive you want to defragment, and click **Defragment disk**.

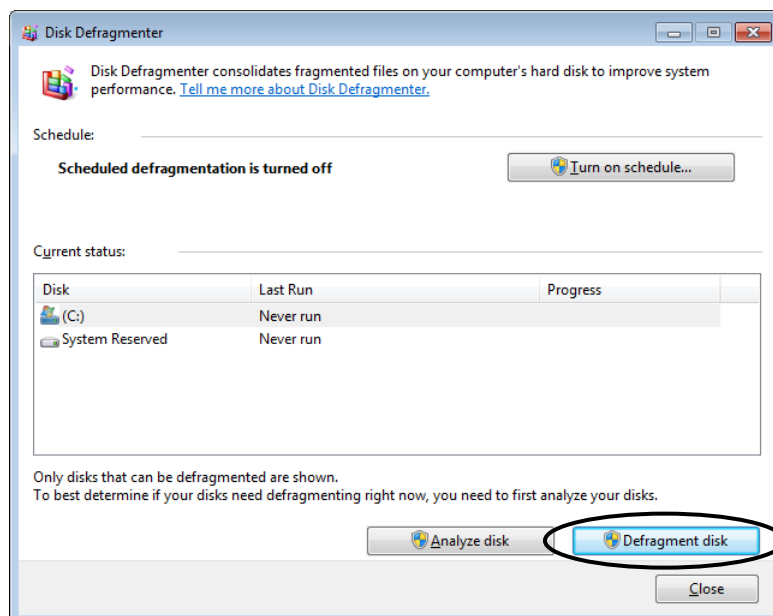

- When the defragmentation process is complete, the date and time of the defragmentation is displayed in the **Last Run** column.

4. PRECAUTIONS WHILE THE OS IS RUNNING

6. Click **Close** to close the window.

7. If you want to disable disk defragmenter schedule, you can do that by using the method below.

- Click **Defragment your hard drive** under **Administrative Tools**.
 - The **Disk Defragmenter** window appears.
Under **Schedule**, click **Turn on schedule**.
 - The **Disk Defragmenter: Modify Schedule** window appears. Check off the **Run on a schedule (recommended)** check box. Then click **OK**.

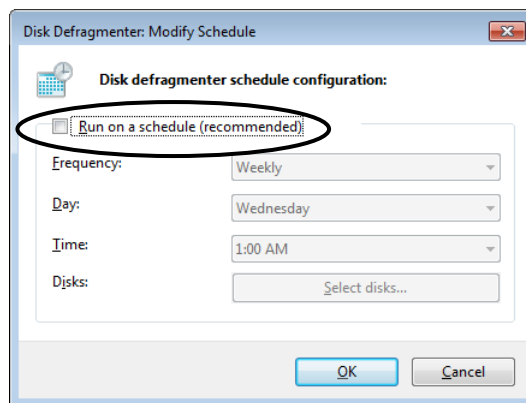

8. Scheduled defragmentation is turned off.

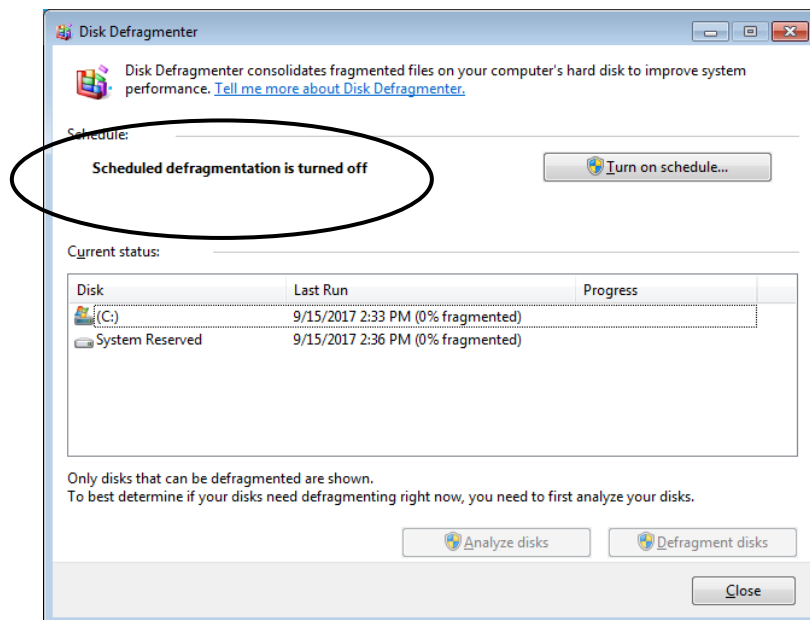

9. Click **Close** to close the window.

4. PRECAUTIONS WHILE THE OS IS RUNNING

4.4 Security Enhancement Function

- Windows® 10

In Windows® 10, a spyware preventive function Windows Defender has been enabled. The Windows Defender also includes a virus preventive function. This virus preventive function may adversely impact application performance compared with when using Windows® 7 in some cases.

- Windows® 7

In Windows® 7, a spyware preventive function Windows Defender has been scheduled and is executed regularly on the background. We recommend that you change the scheduled time as needed so as not to overlap with the operation schedule of job applications.

The initial schedule settings are shown below.

- Frequency: Every day
- Approximate time: 2:00

4.5 Factory-Shipped Network Settings

Turning off SNP (Scalable Networking Pack)

The purpose of SNP is to reduce the processor load by delegating TCP-related processing to the network adapter. SNP is made of the following three features.

- TCP Chimney Offload
- Receive Side Scaling (RSS)
- Network Direct Memory Access (NetDMA)

Unfortunately, if the system in Windows® is used with SNP turned on, processing the network may become unstable, or the network performance may be reduced when you use the network in specific ways. This is why SNP is disabled in this equipment.

In Windows® 10 and Windows Server® 2016, TCP Chimney Offload and Network Direct Memory Access are not supported by OS, so that we set only Receive Side Scaling (RSS) for invalidity.

4.6 Product Activation in Windows® 10

In Windows® 10, product activation is carried out automatically when you connect the Internet connection. If you don't carry out the Product Activation in the environment unconnected to the Internet, "Connect to the Internet to activate Windows" will be displayed on the **Control panel – System and Security - System**, but you can use it as it is.

4.7 Startup Repair Function

Startup repair function cannot be used in Startup Repair window in Windows® 7 because a keyboard or mouse connected to the USB3.0 port dose not work.

4.8 Display of Device Manager

In the **Device Manager** window, the item of **PCI Simple Communications Controller** is in the state which the device driver is not installed. But the operation of the system is not affected because this device is not used.

This Page Intentionally Left Blank

CHAPTER 5 SPECIFICATIONS

5.1 Equipment Specifications

(1) Common specifications

Table 5-1 Common specifications list

Item		Specifications
Model		See “(2) Individual specifications”.
Processor		See “(2) Individual specifications”.
Main memory		8GB / 16GB / 32GB
Display resolution and color depth		See “(6) Supported resolutions”.
Built-in file device	DVD	DVD-RW drive (*1)
	HDD	See “(2) Individual specifications”.
Interface	Display	Digital (DVI-D 24 pins) × 2
		Digital (DisplayPort 20 pins) (*2) (*3) (*4)
	USB	USB2.0/1.1 × 2 (front × 2)
		USB3.0/2.0/1.1 × 6 (rear × 6)
	Serial	RS-232C (D-sub 9 pins) × 1, Option × 1
	LAN	1000BASE-T/100BASE-TX/10BASE-T by auto-negotiation × 2 (RJ45, Wake on LAN supported)
	Audio	LINE IN × 1, LINE OUT × 1
External control	Option × 1	
Extended slot	PCI Express	SLOT1 : PCIe (x4) Full height Short size (*5) SLOT2 : PCIe (x16) Full height Short size (*6) SLOT3 : PCIe (x1) Full height Short size (The connector is PCIe(x16))(*6) SLOT4 : PCIe (x1) Full height Short size (The connector is PCIe(x4))
	PCI	SLOT5 : PCI Full height Long size (5V 32bit / 33MHz) SLOT6 : PCI Full height Long size (5V 32bit / 33MHz) SLOT7 : PCI Full height Long size (5V 32bit / 33MHz)
External Dimensions (Width × Depth × Height)		400 × 450 × 150 mm (rubber feet and rack-mounting metal fittings not included)
RAS features		Hardware status monitoring (fan failure, temperature failure, SMART, drive operating time, and others), OS deadlock monitoring, watchdog monitoring, alarm notification when failure is detected (pop up notification, Digital LEDs for Status indication, remote notification, and others), memory dump collection, maintenance operation support commands, and simulation function
Weight		See “(2) Individual specifications”.
Inrush current		60 A or less (115 VAC), 120A or less (230 VAC)
Leakage current		3.5 mA or less
Consumption current (Max.) AC100V/AC240V (*10)		1.9A/0.8A
Rated current AC100V/AC240V		3.5A/1.5A
Power	Voltage	100 - 240 VAC ± 10% (wide range input)
	Frequency	50/60 Hz ± 3 Hz
Keyboard and mouse		Option

5. SPECIFICATION

(*1) The DVD drive in this equipment supports the following types of media.

Read supported : CD-ROM, DVD-ROM

Read/Write supported : DVD-RW, DVD-R

Depending on the type of CD or DVD used, you may not be able to read or write to the disc.

In this case, use another CD or DVD.

Note : DVD-RAM media is not supported.

(*2) If you use DisplayPort-DVI conversion adapter for triple display, you must select the active conversion adapter and perform the prior evaluation.

When you use DisplayPort-DVI conversion adapter, you must confirm the output resolution specification of DisplayPort-DVI conversion adapter.

(*3) Audio output of DisplayPort is not supported.

(*4) DisplayPort-VGA (analog RGB) conversion adapter is not supported.

(*5) SLOT 1 can not be used because RAID card is installed.

(*6) By the BIOS setup, you can change the number of the available lanes as follows.

See "5.6 BIOS setup" if you want to change the BIOS setup.

BIOS settings	Slot2	Slot3
Setting 1 (Default)	PCI Express x16	PCI Express x1
Setting 2	PCI Express x8	PCI Express x8

(*7) Consumption current (Max.) is a measurement value with the following configuration.

OS : Windows Server® 2016

HDD : SATA HDD 2TB × 2

Main memory : 32GB

Extended slot : Option LAN adapter × 3 (PCI-Express), LAN adapter × 3 (PCI)

USB device : USB keyboard, USB Mouse, USB HDD × 6

(2) Individual specifications

Table 5-2 Individual specifications list

Item		Specifications
		HF-W7500 model 50
Model (*1)		HJ-7550-xxxD
Processor		Intel® Xeon® E3-1275 v5
Built-in file device (*2) (*3)	HDD1	SATA HDD 2TB (Required option)
	HDD2	SATA HDD 2TB (Required option)
Weight		About 13 kg

(*1) The “xx” denotes the OS type. For details about OS types, see “ (3) Pre-installed OS model specifications”.

If “xx” is “NO”, an OS is not installed.

Depending on a destination, “y” is either “J” (Domestic area) or “M” (International area).

(*2) For information about the precautions for hard disks, see “PRECAUTION 4. HARD DISK DRIVES (HDDs)”.

(*3) Do not install the different capacity HDDs for HDD1 and HDD2. You must install the same capacity HDDs for HDD1 and HDD2.

5. SPECIFICATION

(3) Pre-installed OS model

Table 5-3 OS type list

OS type	Pre-installed OS
SD	Microsoft® Windows® Server® 2016 Standard (64bit) (Embedded licensing version)
WE	Microsoft® Windows® 10 IoT Enterprise 2016 LTSC (64bit) (Embedded licensing version)
WA	Microsoft® Windows® 7 Professional for Embedded Systems SP1 (64bit) (Embedded licensing version)

(4) Accessories

Table 5-4 Accessories list

Item	Specifications
Power cord	7 A 125 V two-prong plug with ground pole
Manual	SAFETY INSTRUMENTS (Manual number WIN-B-0007)

(5) Option specifications

Table 5-5 Option specifications

Item	Specifications
LAN adapter	1000BASE-T/100BASE-TX/10BASE-T by auto-negotiation × 2 (For details, see “(8) Optional LAN adapter specifications (HJ-F6550-20)”.)
External control port	B contact, including RS232C × 1 port (D-sub 9 pins) (For details, see “5.9.2 External control specifications”.)
	A contact, including RS232C × 1 port (D-sub 9 pins) (For details, see “5.9.2 External control specifications”.)
Service menu	General Q and A service (10 incidents per year)
	Failure analysis support service (5 incidents per year)
	Failure analysis support service (1 incident)
Optional tool	System failure monitoring tool “RunWatcher® R2”

(6) Supported resolutions

Table 5-6 Supported resolutions list

Screen settings		
Resolution	Refresh rate (*1)	
	DVI-D	DisplayPort
	Digital	Digital
800×600	60Hz	60Hz
1024×768	60Hz	60Hz
1280×1024	60Hz	60Hz
1920×1080	60Hz	60Hz
1920×1200	60Hz	60Hz
2560×1440	-	60Hz
3840×2160	-	60Hz

(*1) It has been confirmed that all refresh rate settings indicated in the table actually work in the test environment provided by Hitachi. It should be noted that supported resolutions and refresh rates are different depending on the display. Consequently, some settings may not be used for a specific display.

(7) Main memory specifications

Only the following combinations can be used for the configuration of the main memory of this equipment.

Table 5-7 Main memory constitution list

Slot A	Slot B	Total capacity
4GB	4GB	8GB
8GB	8GB	16GB
16GB	16GB	32GB

(8) Optional LAN adapter specifications (HJ-F6550-20)

Table 5-8 Optional LAN adapter specifications list

Item	Specifications
Interface	1000BASE-T/100BASE-TX/10BASE-T by auto-negotiation × 2 (RJ45, Wake on LAN not supported)
Installed slot	PCI Express x4
Dimensions	120.0mm × 135.4mm (Include full height bracket)
Weight	About 70g

(9) Maximum current specifications (USB port, Extension board, DisplayPort)

The following table shows the maximum total current consumption for the USB ports, extension slots (PCI Express / PCI) and DisplayPort.

Table 5-9 Maximum current specifications

DC Output	Maximum total current consumption for USB port 8 ports/ Extension board 3 slots/ DisplayPort 1 port
3.3V	8.0A
5V	8.0A
12V	8.0A
-12V	0.2A

The following table shows the maximum current consumption for each of the USB ports, extension slots (PCI Express / PCI) and DisplayPort. Make sure that the inrush current when a device is connected does not exceed the specified maximum current. If the inrush current exceeds the specified maximum current, the surge protection circuit may be activated and the connected device may not be recognized.

Table 5-10 Maximum current specifications by function

Item	Voltage	Maximum current
USB2.0/1.1 port	5V	0.5A/port
USB3.0/2.0/1.1 port	5V	0.9A/port
PCI Express slot SLOT 2 / SLOT 3	3.3V	3.0A/slot
	12V	5.5A/slot
PCI Express slot SLOT 4	3.3V	3.0A/slot
	12V	2.1A/slot
PCI slot	3.3V	6.0A/slot
	5V	5.0A/slot
	12V	0.5A/slot
	-12V	0.1A/slot
DisplayPort	3.3V	0.5A/port

5.2 Memory Space

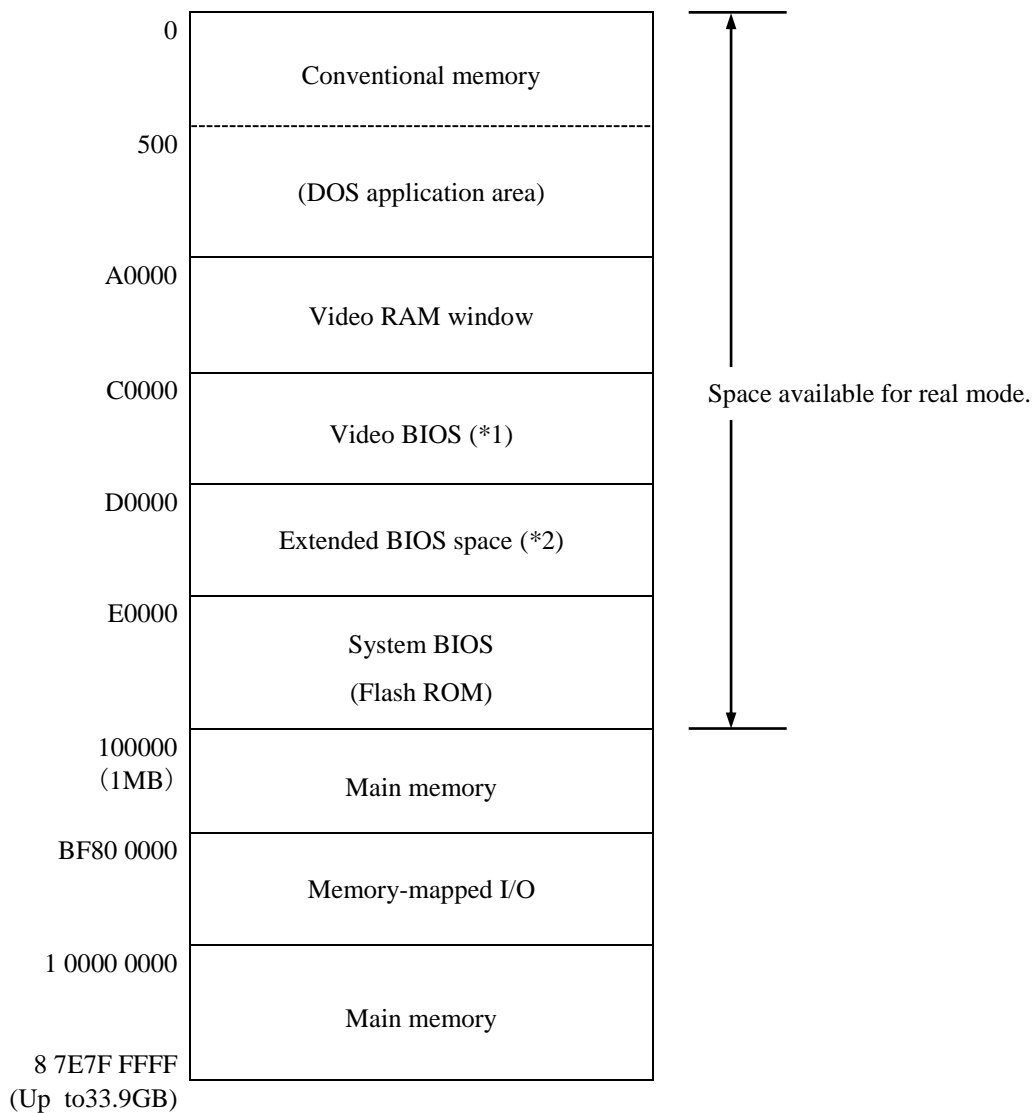

(*1) The size of the video BIOS may change in future versions.

(*2) The extended BIOS space is a narrow space between D0000 and DFFFF and may already be in use by other devices. In addition, the size of the BIOS of standard built-in adapters may change in future versions. It is advisable that you do not use the extended BIOS space if at all possible when you design a new device. If you do, a contention may occur between devices and malfunctions of the devices may result.

5.3 I/O Space

Table 5-11 I/O Space list

I/O address	Device name
0020 – 002D	Interrupt controller
0030 – 003D	Interrupt controller
0040 – 0043	System timer
004E – 004F	Super I/O configuration
0050 – 0053	System timer
0060、0062、0064、0066	Keyboard controller
0061	NMI controller
0070 – 0077	RTC controller
0080	DMA
0092	Reset controller
00A0 – 00B1	Interrupt controller
00B2 – 00B3	Power management controller
00B4 – 00BD	Interrupt controller
00F0	Coprocessor
0000 – 00FF	Reserved (Domain except the above)
0240 – 025F	RAS LSI register
0290 – 02AF	Super I/O
02F8 – 02FF	Serial port 2 (COM2)
03F8 – 03FF	Serial port 1 (COM1)
04D0 – 04D1	Interrupt controller
0CF8 – 0CFB	PCI configuration (address)
0CF9	Reset controller
0CFC – 0CFF	PCI configuration (data)
0100 – 0CFF	Reserved (Domain except the above)
164E – 164F	Reserved
1800 – 18FE	ACPI controller
E060 – E08B	SATA controller
EFA0 – EFBF	SMBus controller
FF00 – FFFF	Reserved

5.4 Interrupts list

Table 5-12 Interrupts list

Interrupt pin	Description
IRQ0	Cascade (from 8259 #1)
IRQ1	Not used
IRQ2	Timer
IRQ3	Serial port 2 (COM2) : B
IRQ4	Serial port 1 (COM1) : A
IRQ5	Not used
IRQ6	Not used
IRQ7	Not used
IRQ8	Real-time clock
IRQ9	SCI, SMBus
IRQ10	Not used
IRQ11	Not used
IRQ12	Not used
IRQ13	Coprocessor
IRQ14	Not used
IRQ15	Not used
IRQ16	PCI Express slot1, PCI Express slot2, PCI slot6, SATA controller
IRQ17	PCI Express slot3, PCI slot7
IRQ18	PCI Express slot4
IRQ19	PCI slot5
IRQ20	Not used
IRQ21	Not used
IRQ22	Not used
IRQ23	Not used
MSI	xHCI, Onboard Video, Onboard LAN

< NOTE >

- The above list is valid when the APIC is enabled.
- The IRQ numbers of PCI slots are valid when the INT A terminal is used.
- The IRQ numbers are fixed and you cannot change the settings shown above.
- Even under APIC-capable OS, APIC-enabled IRQ numbers are assigned only while the corresponding device is active. In other cases, APIC-disabled IRQ numbers are assigned instead(see the next page).

5. SPECIFICATION

Table 5-13 Interrupts list (IRQ assignment when the APIC is disabled)

Interrupt pin	Description
IRQ0	Timer
IRQ1	Not used
IRQ2	Cascade
IRQ3	Serial port 2 (COM2): B
IRQ4	Serial port 1 (COM1): A
IRQ5	Not used
IRQ6	Not used
IRQ7	Not used
IRQ8	Real-time clock
IRQ9	SATA, SCI, All PCI devices
IRQ10	Not used
IRQ11	Not used
IRQ12	Not used
IRQ13	Coprocessor
IRQ14	Not used
IRQ15	Not used

5.5 Serial Port Settings

The factory default settings for the serial ports are as follows. Do not change those settings. If you do, the equipment may not work properly.

Table 5-14 Serial port default settings

Name recognized by the BIOS	I/O address (*1)	IRQ assignment (*1)	Name recognized by the OS	Note
Serial port A	3F8h	IRQ 4	COM1	Standard feature
Serial port B	2F8h	IRQ 3	COM2	Option (*2)

(*1) Automatically assigned by the BIOS.

(*2) When there is not an option board, COM2 is always displayed in device managers.

5.6 BIOS Setup

The BIOS stores the system configuration information in the SPI-ROM. When the system configuration is modified, it may be necessary to change the BIOS settings.

< NOTE >

When the equipment is shipped, the BIOS is configured in accordance with the system configuration.

If the BIOS settings are changed, the system may not operate stably or may not start properly. Pay sufficient attention when you change the BIOS settings.

(1) Starting the setup menu

When you set up the BIOS, start the setup menu.

When turn on the power, messages ralated system initialization will be displayed. Press the **F2** key to launch the setup menu.

(2) Maneuvering through the setup menu

Use the following keys to maneuver through the menu.

Table 5-15 BIOS Setup menu operation key

Key name	Description
Esc	Used for exiting the setup or returning from a lower menu to a higher menu.
← or →	Used for selecting a menu or selecting a menu group displayed at the top of the screen.
↑ or ↓	Used for selecting an item or selecting a sub-item under a menu group.
+ or -	Used for selecting a value for the setting. By pressing those keys, the setting switches among the available options.
Space	Used for selecting a value for the setting. If there are only two available options, the setting toggles when you press the key.
Tab	When you configure the date and time, by pressing this key, the focus moves between setting items, for example, from month to day and from hour to minute.
Enter	Used for moving from a higher menu to a lower menu, exiting the setup (saving data to the SPI-ROM), or other purposes.

(3) Overview of the setup menu

The setup menu consists of the following items:

Main: This is the screen displayed when the menu starts. You can configure basic system settings such as date and time.

Advanced: You can configure detailed system settings such as interrupt ports and I/O address settings.

Power: You can configure the automatic power shutdown at failure detection, the operating mode for when the power is turned on, and others settings.

Boot: You can configure the priority order of the devices from which an OS is booted.

Exit: You can save modified configuration information to the SPI-ROM, reset configuration information back to the default settings, and make other changes.

5. SPECIFICATION

(4) Details of the setup menu

The following tables show the details of the items you can set up in each menu.

Table 5-16 BIOS Setup menu list (1/3)

Top menu	Setting item	Default value	Note	
Main	System Date		When you set the system up for the first time, be sure to configure these two items. (*1)	
	System Time			
	Drive1	Automatically recognized	Allocation : Drive bay 1	
	Drive2	Automatically recognized	Allocation : Drive bay 2	
	Drive3	Automatically recognized	Allocation : DVD Drive	
	Boot Options	Reset button function	Reset	Configures the function of the reset switch. If you change the setting to NMI (Non-Maskable Interrupt), you can change the reset switch to an NMI switch. (*2)
		Quick Boot Mode	Disabled	If you change the setting to Enabled, you can skip the memory check and the startup time will be shortened. In normal operation, specify Disabled for the setting.
		Correctable ECC Error	Pass	Specifies whether to display a message and pause the startup or to ignore the error and proceed with the startup when a Correctable ECC Error is detected.
	System Memory		Automatically recognized	-
	BIOS Version		Automatically recognized	-
	Information	Microcode Version	Automatically recognized	-
		VBIOS Version	Automatically recognized	-
		Memory RC Version	Automatically recognized	-
ME Firmware Version		Automatically recognized	-	

(*1) The date and time are reflected in RTC (real time clock) at these of change.

(*2) A setting change to “NMI” gives you more chances of non-maskable interrupt, thereby increasing the possibility of successful memory dump initiated by the reset button at an error occurrence during OS startup/shutdown.

For information about a memory dump, see “8.2 Collecting a Memory Dump”.

Table 5-16 BIOS Setup menu list (2/3)

Top menu	Setting item		Default value	Note	
Advanced	PCI Configuration	PCI-Express Device Slot #1 to #4	Enable Master	Enabled	
			Option ROM Scan	Enabled	Specifies whether to execute the extension ROM. If you specify Disabled for this setting, the extension ROM will not be executed.
			Link Speed	Auto	
		PCI Device Slot #5 to #7	Enable Master	Enabled	
			Latency Timer	0040h	
			Option ROM Scan	Enabled	Specifies whether to execute the extension ROM. If you specify Disabled for this setting, the extension ROM will not be executed.
		PCI Parity Error Detection		Enabled	
	PCI-Express link width (Slot#2/3)		x16/x1	Specifies the number of lanes of Slot2 and Slot3.(3)	
	I/O Device Configuration	Serial port A		Enabled	Do not change this setting.
		Base I/O Address		3F8h	
		Interrupt		IRQ4	
		Serial port B		Enabled	
		Base I/O Address		2F8h	
		Interrupt		IRQ3	
	Core Multi Processing			Enabled	
	Hyper Threading			Disabled	(*4)
	No Execute Mode Mem Protection			Enabled	
	MMIO Range			Dynamic	
	Legacy USB Support			Enabled	Specifies whether to activate USB devices. If you specify Disable for this setting, you can use a USB keyboard only for the setup menu and after Windows® starts.
	Front USB Port			Enabled	You can change the setting of the front USB port to enable or disable.
Internal Graphics			Auto	Do not change this setting.	
UEFI Boot			Disabled	Do not change this setting.	
Secure boot Configuration			—	Do not change this setting. When the setting of UEFI Boot is “Enabled”, you can change this setting.	

(*3) By the setting value, you can change the number of the available lanes as follows.

Settings	Slot2	Slot3
x16 / x1 (Default)	PCI Express x16	PCI Express x1
X8 / x8	PCI Express x8	PCI Express x8

5. SPECIFICATION

(*4) If you use this equipment in another setting ("Hyper Threading" is "Enabled"), the environmental condition is as follows.

- Ambient temperature (Operation) : 5 to 35°C

If you use this equipment in default setting ("Hyper Threading" is "Disabled"), the environmental condition is as follows.

- Ambient temperature (Operation) : 5 to 40°C

Table 5-16 BIOS Setup menu list (3/3)

Top menu	Setting item	Default value	Note
Power	After AC Power On	Auto	<p>Specifies the action when the power to the equipment is turned on.</p> <p>Power On : When the power is turned on, the OS is started automatically.</p> <p>Stay Off : When the power is turned on, the system goes into the soft power off mode.</p> <p>Auto : If the OS was running the last time the power was turned off, the OS starts as in the case of Power On. If the OS was not running the last time the power was turned off, the system goes into the soft power off mode as in the case of Stay Off.</p> <p>If the backup battery runs out or the battery is not connected and the power is off, the setting is the same as Stay Off.</p> <p>For details, see “PRECAUTION 11. BIOS SETTINGS”.</p>
	FAN failure detection	Enabled	<p>Specifies whether the until will detect a fan failure when the power is turned on.</p> <p>Do not change this setting.</p>
	Power saving mode	Disabled	<p>Specifies whether to launch the CPU in the power saving mode.</p> <p>Do not change this setting.</p>
Boot	Boot Priority Order	<ol style="list-style-type: none"> 1. USB FDD 2. SATA CD/DVD 3. USB CD 4. DRIVE1 5. DRIVE2 6. PCI SCSI ! 7. OPTION PORT ! 8. USB HDD 9. Internal Shell 	<p>Do not change this setting.</p> <p>Configures the priority order of the devices from which an OS is booted.</p>
Exit	Exit Saving Changes		Saves the changes you made in the setup into the SPI-ROM and reboots the system.
	Exit Discarding Changes		Discards the changes you made in the setup and reboots the system with the configuration you saved in the SPI-ROM last time.
	Load Setup Defaults		<p>Loads the BIOS default settings.</p> <p>Default values are loaded but not saved in the SPI-ROM. If you want to save the default settings in the SPI-ROM, use “Exit Saving Changes”.</p>

(5) Restoring the default settings

When you want to restore all items in the setup menu back to the default settings, follow the procedure below:

1. Start the setup menu. (See “(1) Starting the setup menu”.)
2. Open **Exit** in the top menu. Move the cursor to **Load Setup Defaults** and press **Enter**.
The message “Load default configuration now?” is displayed.
3. Select “Yes” and press **Enter**.
4. Open **Exit** in the top menu again. Move the cursor to **Exit Saving Changes**. Press **Enter**. The message “Save configuration changes and exit now?” is displayed.
5. Select “Yes” and press **Enter**.

This completes the procedure.

5.7 Boot menu

When starting up the system, you can boot from a device different from the boot device priority in the BIOS setup menu, and start the BIOS setup menu and Internal Shell.

< NOTE >

When the equipment is shipped, the Boot menu is configured in accordance with the system configuration.

If the boot device is changed, the device may be unrecognized. Pay sufficient attention when you change the Boot device.

(1) Starting the Boot menu

When turn on the power, system initialization messages will be displayed. Press the **F5** key to launch the Boot menu.

(2) Maneuvering through the setup menu

Use the following keys to maneuver through the menu.

Table 5-17 Boot menu operation key

Key name	Description
Esc	Used for exiting the setup or returning from a lower menu to a higher menu.
↑ or ↓	Used for selecting a sub-item under a menu group.
Enter	Used for starting a selected item.

Table 5-18 Boot menu list

Top menu	Item (*1)	Behavior	Note
Boot Menu	SATA CD/DVD	Start up from internal DVD drive.	These are only displayed that the devices are connected and enabled by Boot Priority Order in the BIOS setup menu.
	DRIVE1	Start up from Drive bay 1.	
	DRIVE2	Start up from Drive bay 2.	
	Internal Shell	When the setting of UEFI Boot is “Enabled”, start up the Internal Shell.	
App Menu	Setup	Start up the Setup menu.	
	Internal Shell	Start up the Internal Shell.	

(*1) The device name is displayed next to the item of Boot Menu.

5.8 Hardware System Clock

This equipment has a hardware system clock that uses an RTC (real-time clock) IC.

The clock has a built-in calendar and continues to work using a backup battery even when the system power is off.

Table 5-19 Hardware System Clock Specification

Item	Specifications
Time function	Hour/Minute/Second (24-hours clock)
Date function	Year/Month/Date
Precision	± 4 seconds per day (*)
Battery backup	Lithium battery

(*) Rough estimates when the ambient temperature is 25°C.

For your information, the system program normally updates the internal clock by using a periodic timer. The internal clock is adjusted by reading the time and date from the hardware clock when, for example, the system starts.

5.9 Interface Specifications

5.9.1 Connector specifications

The following shows the specifications of the interfaces from this equipment to external devices.

For information about the location of the ports, see “1.5 Name and Function of Each Part”.

(1) Motherboard (Standard)

- USB2.0/1.1 port (front)

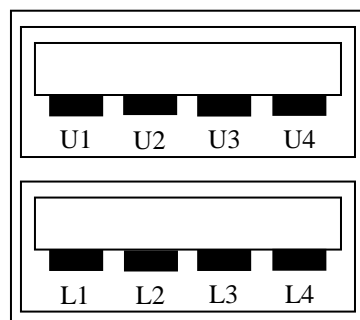

Pin No.	Signal name
U1	+5V
U2	USBD1-
U3	USBD1+
U4	GND
L1	+5V
L2	USBD0-
L3	USBD0+
L4	GND

- USB3.0/2.0/1.1 port (rear)

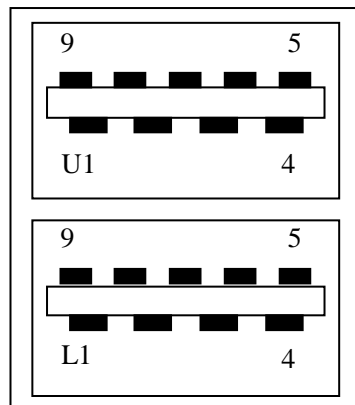

Pin No.	Signal name	Pin No.	Signal name
L1(1)	+5V	U1(10)	+5V
L2(2)	USBD0-	U2(11)	USBD1-
L3(3)	USBD0+	U3(12)	USBD1+
L4(4)	GND	U4(13)	GND
L5(5)	SSRX1-	U5(14)	SSRX2-
L6(6)	SSRX1+	U6(15)	SSRX2+
L7(7)	GND	U7(16)	GND
L8(8)	SSTX1-	U8(17)	SSTX2-
L9(9)	SSTX1+	U9(18)	SSTX2+

5. SPECIFICATION

- Serial port (male connector, inch screws) (COM1, COM2 (optional))

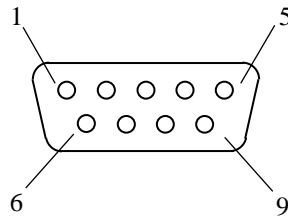

Pin No.	Signal name	Pin No.	Signal name
1	CD	6	DSR
2	RD	7	RTS
3	TD	8	CTS
4	DTR	9	RI
5	GND		

- LAN port (RJ-45 modular port 8 pins)

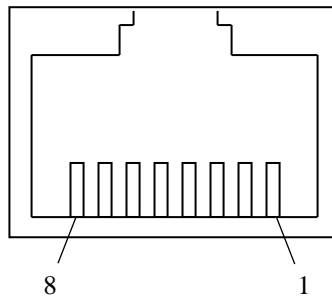

Pin No.	Signal name
1	TRD0+
2	TRD0-
3	TRD1+
4	TRD2+
5	TRD2-
6	TRD1-
7	TRD3+
8	TRD3-

For network connection, use a cable specified as follows.

Cable specification: UTP cable (twisted-pair cable without shield) category 5e or 6

- Video port (DVI-D 24 pins, inch screws)

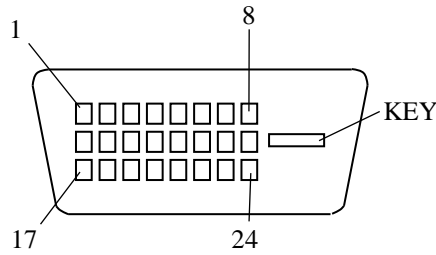

Pin No.	Signal name	Pin No.	Signal name	Pin No.	Signal name
1	TX2M	9	TX1M	17	TX0M
2	TX2P	10	TX1P	18	TX0P
3	SGND	11	SGND	19	SGND
4	NC(TX4M)	12	NC(TX3M)	20	NC(TX5M)
5	NC(TX4P)	13	NC(TX3P)	21	NC(TX5P)
6	DDCCLK2	14	P5DFP	22	SGND
7	DDCDAT2	15	PGND	23	TXCP
8	NC(V-Sync)	16	HP(SENSE)	24	TXCM

Note: This video port supports Single-Link only.

- Video port (DisplayPort 20 pins)

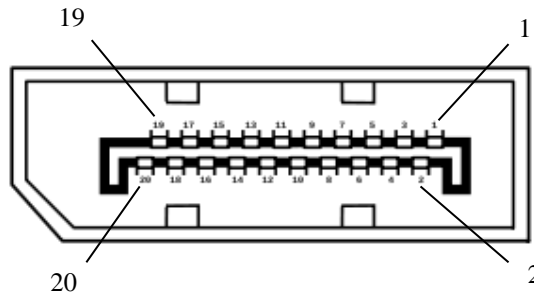

Pin No.	Signal name	Pin No.	Signal name
1	MainLane0+	11	GND
2	GND	12	MainLane3-
3	MainLane0-	13	CONFIG1
4	MainLane1+	14	CONFIG2
5	GND	15	Aux+
6	MainLane1-	16	GND
7	MainLane2+	17	Aux-
8	GND	18	HotPlug
9	MainLane2-	19	GND
10	MainLane3+	20	+3.3V

Note 1: If you use DisplayPort-DVI conversion connector for triple display, you must select the active conversion connector and perform the prior evaluation.

Note 2: When you use DisplayPort-DVI conversion connector, you must confirm the output resolution specification of DisplayPort-DVI conversion connector.

5. SPECIFICATION

- Audio port: LIN and LOU (3.5φ stereo audio port)

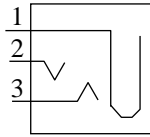

LIN		LOUT	
Pin No.	Signal name	Pin No.	Signal name
1	AGND	1	AGND
2	LIN_L	2	LOUT_L
3	LIN_R	3	LOUT_R

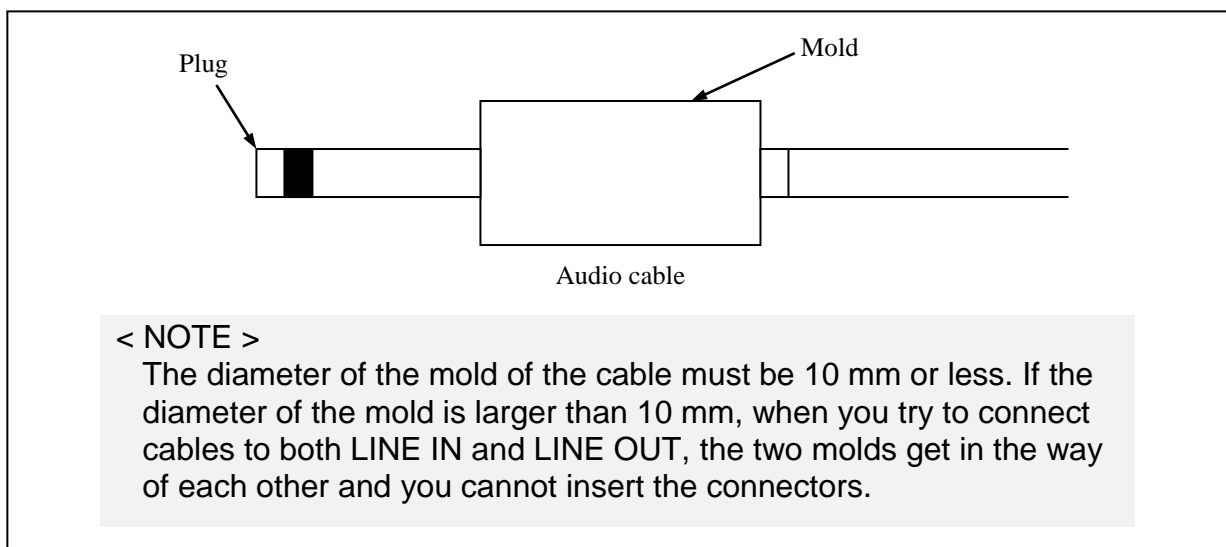

(2) RAS external control interface (optional)

Note: Serial port and External control I/O port

- External control I/O port (male connector, inch screws)

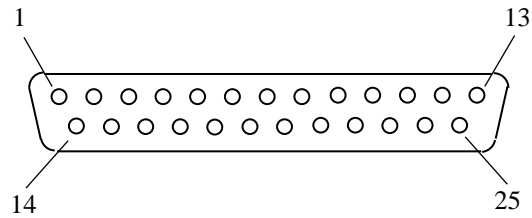

Pin No.	Signal name	Pin No.	Signal name
1	MCALL_1	14	MCALL_2
2	GENDO0_1	15	GENDO0_2
3	GENDO1_1	16	GENDO1_2
4	WDTTO_1	17	WDTTO_2
5	PSDOWN_1	18	PSDOWN_2
6	GENDI0_1	19	RMTPWON_2 /GENDI2_2
7	RMTSTDN_1 /GENDI_1	20	RMTSTDN_2 /GENDI_2
8	RMTRESET_2	21	GENDI1_2
9	CPUSTOP_2	22	GENDI0_2
10	GENDO2_2	23	CPUSTOP_1
11	RMTRESET_1	24	GENDO2_1
12	GENDI1_1	25	GND
13	GENDI2_1		

5.9.2 External control specifications

(1) External control I/O port (EXT) specifications

Table 5-20 External control I/O port specifications

Item	Sub-item		Specification
External control input	Usage		RMTRESET, RMTSHTDN (GENDI), GENDI0, GENDI1, and GENDI2 (RMTPWRON) (*1) (*2) (*3)
	Electrical interface	Interface	Non-voltage transistor contact
		Contact current	1 mA/point
		Applicable load	<ul style="list-style-type: none"> • Relay (gold-plated twin contact) • Switch • Isolated open collector
External control output	Usage		CPUSTOP, WDTTO, PSDOWN(*4), MCALL, GENDO0, GENDO1, and GENDO2
	Electrical interface	Interface	PhotoMOS relay contact
		Load voltage	Up to 40 VDC (external power supply required)
		Load current	Steady-state : Up to 0.1 A/point Inrush : Up to 0.6 A/point, 100 ms
		Dielectric strength	250 VAC, one minute
		Applicable load	<ul style="list-style-type: none"> • Relay (clamp diode required) • Buzzer • Indicator • Semiconductor device

(*1) RMTSHTDN and GENDI use the same contact (switched by the RAS software setting).

RMTPWRON and GENDI2 use the same contact (switched by the jumper pin setting). For details, see "6.6 Enabling the Remote Power On Function".

(*2) When you use the RMTPWRON function, make sure no noise is added to the external contact.

If the contact is closed for 15 ms or more during the soft power off mode due to noise or other reasons, the power may be turned on unexpectedly. As a side note, while the OS or BIOS is running after power on, the RMTPWRON function is disabled and the contact can be used as a GENDI2 input.

(*3) When using the RMTPWRON function, the equipment will start up from the standby state, but note that the RMTPWRON function will not operate in the following cases.

- The RMTPWRON function will not operate in the case that "After AC Power On" setting of the BIOS is "Power On" or "Auto", and the AC input turned OFF / ON after pressing the power switch for 4 seconds to enter the standby state.

(*4) When you restart the equipment after AC power off, PSDOWN is output once before the OS start if the BIOS setup of the equipment is as follows.

- The expansion slot settings in the BIOS setup : Slot2 is PCI Express x16, Slot3 is PCI Express x1
(Default settings)

This behavior is necessary to set the Slot2 in PCI Express x16 and to set Slot3 in PCI Express x1.

Please design the system to ignore PSDOWN before the OS start if you use PSDOWN.

This behavior doesn't occur if the Slot2 and the Slot3 are set in PCI Express x8 by the expansion slot settings in the BIOS setup. See "5.6 BIOS setup" for the expansion slot settings.

(2) List of external control I/O signals

Table 5-21 List of external control I/O signals (1/2)

Signal name	Connection diagram			Meaning	HJ-F6550-17 B contact specifications	HJ-F6550-18 A contact specifications
	CPU side	Terminal No.	User side			
PSDOWN_1 PSDOWN_2	40 VDC 0.1A Contact spec 	5 18 		Activated when the OS is shut down (standby or the main power is off) or when power is not supplied to the equipment.	When the power is off Contact closed (B contact)	When the power is off Contact open (A contact)
CPUSTOP_1 CPUSTOP_2	40 VDC 0.1A Contact spec 	23 9 		Activated when the OS, application, device driver, or the like cannot run properly due to an abnormally high system load or has crashed.	When the power is off Contact closed (B contact)	When the power is off Contact open (A contact)
MCALL_1 MCALL_2	40 VDC 0.1A Contact spec 	1 14 		This is a maintenance request signal. This contact is activated when the temperature, the fan status or one side of mirrored disks (B model only) is abnormal.	When the power is off Contact open (A contact)	When the power is off Contact open (A contact)
GENDO0_1 GENDO0_2	40 VDC 0.1A Contact spec 	2 15 		These are general-purpose contact output signals. A user can assign a function to each one of the contacts GENDO0 through GENDO2.	When the power is off Contact open (A contact)	When the power is off Contact open (A contact)
GENDO1_1 GENDO1_2	40 VDC 0.1A Contact spec 	3 16 			User-defined	User-defined
GENDO2_1 GENDO2_2	40 VDC 0.1A Contact spec 	24 10 			When the power is off Contact open (A contact)	When the power is off Contact open (A contact)
WDTTO_1 WDTTO_2	40 VDC 0.1A Contact spec 	4 17 			User-defined	User-defined
					When the power is off Contact Closed (B contact)	When the power is off Contact open (A contact)
					When watchdog timer timeout occurs or when CPU power is off Contact closed	When watchdog timer timeout occurs or when CPU power is off Contact open

5. SPECIFICATION

Table 5-21 List of external control I/O signals (2/2)

Signal name	Connection diagram			Meaning	HJ-F6550-17 B contact specifications	HJ-F6550-18 A contact specifications
	CPU side	Terminal No.	User side			
RMTSHTDN_1 (GENDI_1) RMTSHTDN_2 (GENDI_2)	5V(VCC) Contact input 777	7 20		This is a shutdown request signal or a general purpose input signal. When this contact is closed, the OS will be shut down. A user can select which signal to use. (*1)	-	-
RMTRESET_1 RMTRESET_2	5V(VCC) Contact input 777	11 8		This is a reset request signal. When this contact is closed, the equipment is hard-reset. (*1)	-	-
GENDIO_1 GENGIO_2	5V(VCC) Contact input 777	6 22		These are general purpose input signals. A user can assign a task to each one of the inputs GENDIO and GENDI1.	-	-
GENDI1_1 GENDI1_2	5V(VCC) Contact input 777	12 21			-	-
GENDI2_1 (RMTPWON_1) GENDI2_2 (RMTPWON_2)	5V(VCC) Contact input 777	13 19		This is a general purpose input signal. A user can assign a task to contact GENDI2. This input can also be used for the remote power on function. (*2)	-	-

(*1) You can use a pulse input for the RMTSHTDN contact and the RMTRESET contact. When you use a pulse, the contact must be closed for at least 500 ms. Note that these two signals should not be closed at the same time.

(*2) Use a pulse input for the RMTPWON contact. Close the contact for at least 100 ms and open it after about 4 seconds or less. If you shut down the system with this contact closed, the system will start as soon as the system goes into the soft power off mode. For information about the location of JP2 pin, see “6.6 Enabling the Remote Power On Function”.

(3) Recommended EXT cable specifications

1. For connection, the following cable is required.

Model: HJ-7805-C1-XX, where the XX part shows the length. (*1)

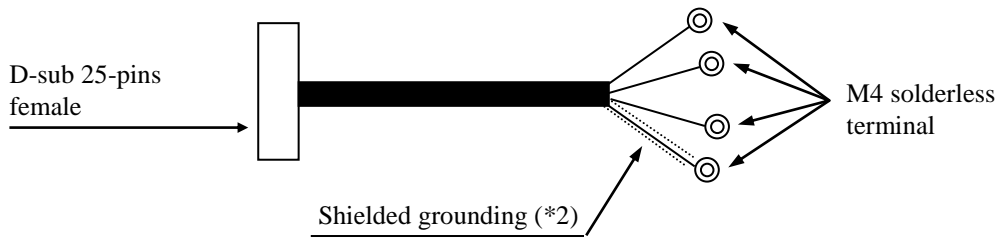

(*1) The maximum cable length is 30 m.

(*2) To connect a cable shield, beside the cable, you must provide a shielded grounding bar dedicated for a shielded wire connection.

2. When a user makes a cable, the user must follow the specifications below.

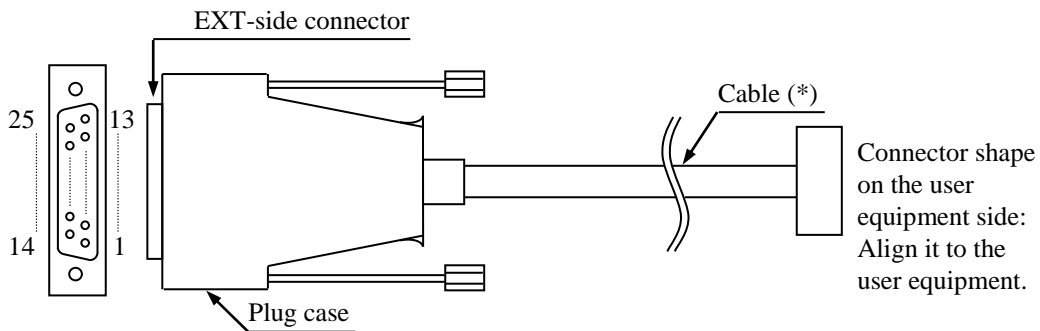

Exterior View of the External Control Cable and Connector

(*) The shielded grounding of the cable must firmly contact the conductor of the plug case (frame ground).
 (Do not connect a GND pin of the EXT port to the shielded grounding because all GND pins are signal ground. If you do so, the equipment may malfunction.

● Cable specification (recommended cable)

Item	Specifications	Note
Maximum cable length	30 m	
Electric shield of the cable	Required	Connected to the frame ground

5. SPECIFICATION

5.9.3 External interface cable length specifications

The recommended maximum cable length for each interface of this equipment is as follows.

Table 5-22 External interface cable length specifications

No.	Connector name	Cable length (m)	Remarks
1	DVI-D port	3	
2	DisplayPort	3	
3	LAN port	100	UTP Category 5e or better
4	External control I/O port (Optional)	30	For information about the cable specifications, see “5.9.2 (3)”.
5	Serial port (COM1)	15	Use a shielded cable.
6	Serial port (COM2) (Optional)		
7	Front USB2.0/1.1 (2 ports)	1	Use a USB 2.0 compliant shielded cable.
8	Rear USB3.0/2.0/1.1 (6 ports)	2	Depending on a device to connect, use a USB 3.0 compliant shielded cable or a USB 2.0 compliant shielded cable.
9	Audio (LINE IN/LINE OUT)	2	

< NOTE >

If you use cables longer than the recommended maximum cable length or if you use an extension cable, it may not operate properly.

A connected device or a conversion connector may not work properly depending on them. Check proper operation of them before you use it.

CHAPTER 6 CHECKUP AND MAINTENANCE

6.1 Daily Checkup



WARNING

Make sure to install a dust filter on the equipment. If you do not, dust enters into the equipment and a fire caused by a short circuit may occur as a result.



CAUTION

Before you clean or replace the dust filter or the case fan of this equipment, make sure you shut down the OS, turn off the main power to the equipment, and wait for at least one minute. Otherwise, injury to hands and fingers may result.

NOTICE

- Before you move this equipment, make sure you shut down the OS, disconnect the plug of the power cord from the outlet, and wait for at least one minute. If you do not, the HDDs and other devices may fail.
- When you transport or carry the equipment, pack it in the dedicated container (container and packing materials used when the equipment was delivered). If you use any other container or packing materials, that may damage the equipment.
- Do not use a damaged or broken dedicated container when you transport or carry the equipment. If you do, that may damage the equipment.

(1) Cleaning a dust filter

NOTICE

If you wash a dust filter, dry it completely before re-attaching it to the equipment. If you use the equipment while its dust filter is not completely dry, the equipment may fail. When you use a cleanser to clean a dust filter, make sure you use a neutral detergent. If you use other types of detergent, the dust filter may lose its function.

(a) Frequency

Clean the dust filter between once per month and once every three months depending on the amount of dust in the environment.

(b) Procedure

1. Shut down the OS.
2. Unplug the power cord from the outlet. Wait for at least one minute before you start cleaning.
3. Take out the dust filter located on the front panel. Then dust or wash the filter. If you wash the filter, wait until the filter is completely dry. Then re-attach it to the equipment. For how to install and remove a dust filter, see “6.3.10 Installing and removing a dust filter”.

(2) Cleaning a keyboard (optional)

When you clean a keyboard, make sure you follow the instructions below:

- Do not spray detergent directly onto the keyboard or spill liquid detergent on it.
- Do not wipe the keyboard with a wet cloth. If you do, the equipment may fail.

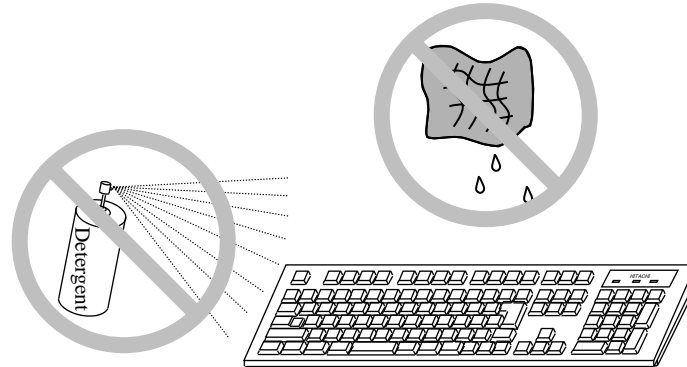

- When you use detergent, spray a minimum amount of detergent on a cloth.
- Before wiping the keyboard with a wet cloth, wring out the cloth well.
- Use a soft cloth such as gauze.
- Before using detergent, carefully read the instructions on use of the detergent.
- Cover the whole keyboard with gauze, spray detergent all over it, leave it for a couple of minutes, and wipe off the keyboard.

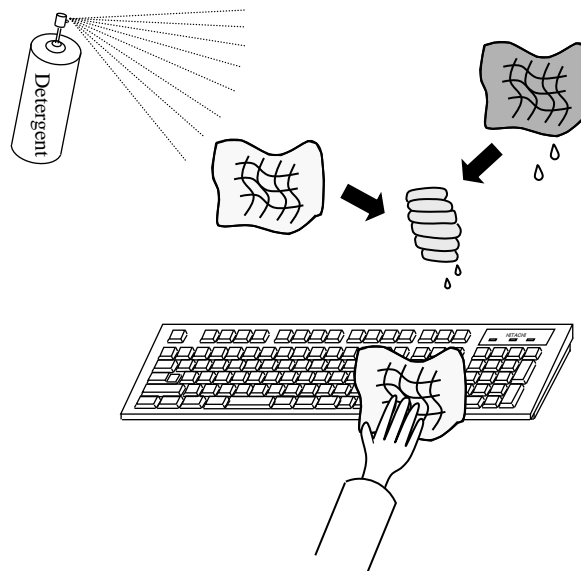
**< NOTE >**

For information about the precautions for USB devices, see “PRECAUTIONS 6. USB DEVICES”.

6.2 Periodic Checkup

The table below shows how to check the Equipment periodically. Qualified maintenance personnel must conduct this periodical checkout. Include the checkout time in the system operation schedule.

Table 6-1 Periodic Checkup

Checkup item	Frequency	Note
Collection of logging information	Once per year	
Inspection and cleaning of the components <ul style="list-style-type: none"> • Inspection and cleaning of the inside and outside of the equipment • Inspection of fan rotation, dust removal • Removal of foreign objects that have entered the equipment • Other general inspection items 	Once per year	
Replacing dust filters	Once per year	
Measuring the power voltage	Once per year	
Operation check <ul style="list-style-type: none"> • Operation check of switches and indicators • Operation check by using test programs 	Once per year	
Periodic replacement of replaceable components (*)	As required	
Routine checkup <ul style="list-style-type: none"> • Cleaning the keyboard • Cleaning dust filters 	Between once per month and once every three months	For details, see section “6.1 Daily Checkup”.

(*) For details about how to handle replaceable components, see “APPENDIX HANDLING REPLACEABLE COMPONENTS”.

6.3 Installing and Removing Components

6.3.1 Types and locations of installed components

The figure below shows the types and locations of the components installed in this equipment.

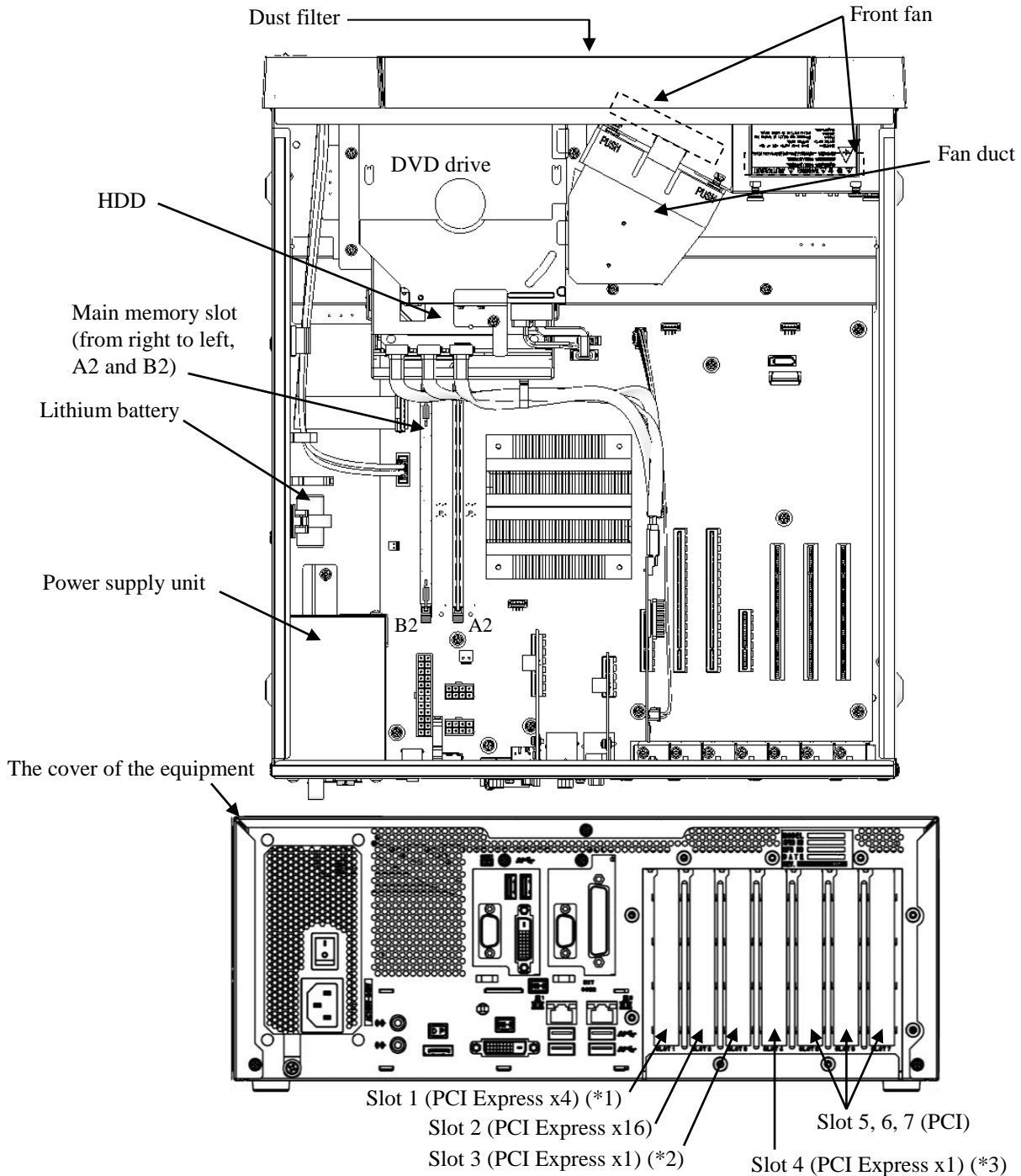

(*1) This slot can not be used because the RAID board is installed.

(*2) A PCI Express x16 connector is used but the internal connection is equivalent to PCI Express x1.

(*3) A PCI Express x4 connector is used but the internal connection is equivalent to PCI Express x1.

Figure 6-1 Types and Locations of Installed Components

6.3.2 Before installing or removing components

When you install or removing components, confirm and adhere strictly to the following instructions.



WARNING

- Do not open the equipment cover if you are not maintenance personnel. In addition, do not install or replace the hardware.
- Before you start the work, make sure you shut down the OS, unplug the power cord from the outlet, and wait for at least one minute. Otherwise, an electric shock or failure of the equipment may result.



CAUTION

Do not directly touch the parts inside the equipment with your hand when you install or remove an extension board. Those parts are hot and if you touch them, you may get burned. In addition, if you touch them, they may get damaged and that may result in failure of the equipment.

- Allocate sufficient clearance for maintenance work. Carry out the work on a flat surface. (See “1.6.2 Installation”.)
- Wear cotton gloves when you install or remove components.
- When you tighten or remove a screw, use a Phillips screwdriver (JIS #1 or JIS#2) to avoid stripping the head.
- When you tighten a screw, drive the screw along the axis of the tapped hole without adding too much torque in order to avoid damaging the thread.

As well as the above, there are instructions for every work item. Confirm and adhere strictly to these instructions.

6.3.3 Installing and removing the cover of the equipment

CAUTION

When you install the cover of the equipment, do not put your fingers inside the cover. If you do, your fingers may get caught and injured.

Before starting to work, see “6.3.2 Before installing or removing components”.

(1) Removing the cover of the equipment

- [1] Remove the three screws on the rear of the equipment.
- [2] Slide the cover to the rear of the equipment.
- [3] Lift the cover up.

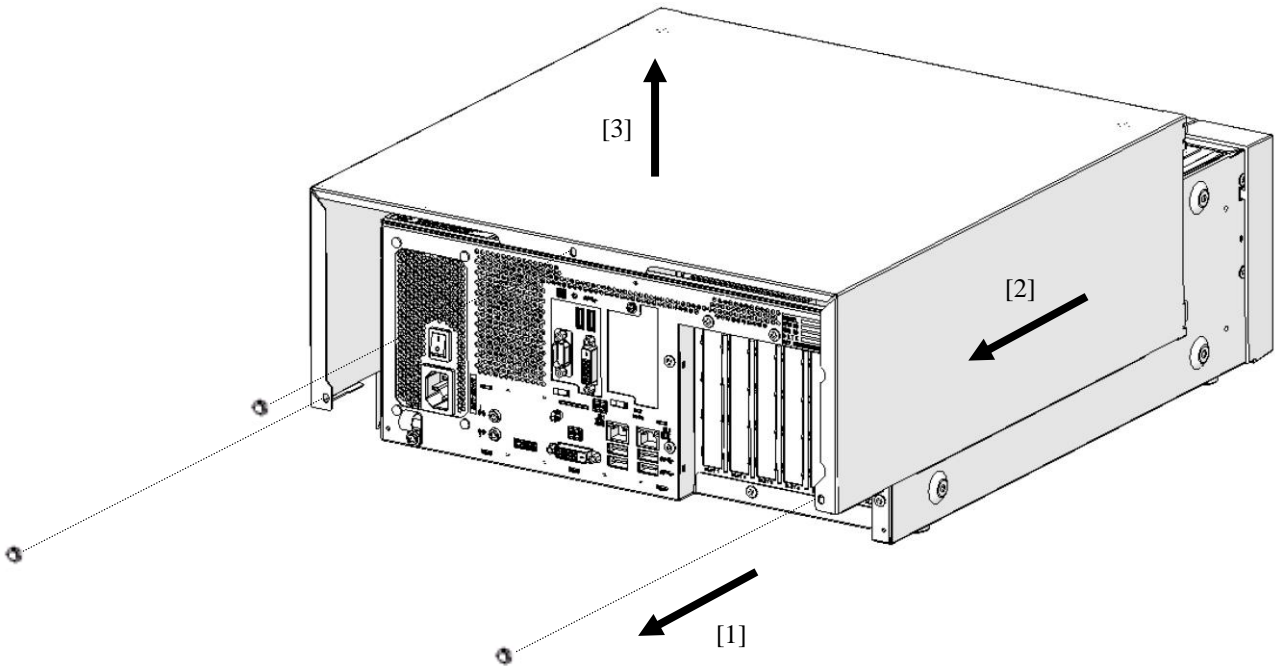

Figure 6-2 Removing the Cover of the Equipment

(2) Installing the cover of the equipment

When installing the cover of the equipment, reverse the procedure described in “(1) Removing the cover of the equipment.” Then install the center screw first, as shown in Figure 6-2.

6.3.4 Installing and removing an extension board



WARNING

Before you install or remove an extension board, make sure you shut down the OS, unplug the power cord from the outlet, and wait for at least one minute. If you install or remove an extension board without shutting down the power, an electric shock or a fire may result.

NOTICE

Make sure you disconnect all external cables connected to the equipment before you install or remove an extension board. Otherwise, failure of the equipment may result.

(1) Before installing or removing an extension board

- Before starting to work, see “6.3.2 Before installing or removing components”.
- When extension boards have been already installed to the slots, install or remove the extension board from a big number slot after removing a small number slot.
- When you install some extension boards at a time, install extension boards in the order that the slot number is larger.
- For information about the location of the extension boards, see “Figure 6-1 Types and Locations of Installed Components”.

< NOTE >

For information about the precautions for extension boards, see “PRECAUTIONS 7. EXTENSION BOARDS”.

(2) Information about extension boards**(a) Types of extension boards**

The equipment has a total of seven extension slots (four PCI Express slots and three PCI slots).

- The PCI Express slots are compliant with PCI EXPRESS BASE SPECIFICATION REVISION 2.0.
- The PCI slots are compliant with PCI LOCAL BUS SPECIFICATION REVISION 2.1.

Table 6-2 Extension boards list

Extension slot	Supported extension board
Slot 1	PCI Express x4 / Full height / Short size (*1)
Slot 2	PCI Express x16 / Full height / Short size
Slot 3	PCI Express x1 / Full height / Short size (*2)
Slot 4	PCI Express x1 / Full height / Short size (*3)
Slot 5	PCI Long size
Slot 6	PCI Long size
Slot 7	PCI Long size

(*1) This slot can not be used because the RAID board is installed.

(*2) A PCI Express x16 connector is used but the internal connection is equivalent to PCI Express x1.

(*3) A PCI Express x4 connector is used but the internal connection is equivalent to PCI Express x1.

(b) Size of extension boards

The board sizes (length × height) in the PCI Express / PCI specifications are as follows (the height includes the connector):

- PCI Express specification
 - Short size: 167.65 × 111.15 (mm)
- PCI specification
 - Short size: 174.63 × 106.68 (mm)
 - Long size: 312.00 × 106.68 (mm)

(3) Removing an extension board or a slot cover

- [1] Follow the instructions in “6.3.3 Installing and removing the cover of the equipment” to remove the cover of the equipment.
- [2] Remove the screw of the slot where you want to install an extension board or a slot, and remove an extension board or a slot cover.



WARNING

Always attach a slot cover to each unused slot and attach a connector cover to each unused connector. Otherwise, failure of the equipment or a fire may result.



CAUTION

If you bend the tab of the grounding spring at the slot by mistake when you remove an extension board, be careful not to cut your fingers when you fix the bend because the tab has a sharp edge.

< NOTE >

There is a case that the panel of the extension board is caught in the claw of the slot earth spring and it is difficult to remove it. Do not pull it by force.

(4) Installing an extension board or a slot cover

- [1] See “(3) Removing an extension board or a slot cover”, and remove the cover of the equipment and an extension board or a slot cover.
- [2] If the PCI connector or the PCI Express connector has a cover, remove the cover.
When installing a slot cover, attach the cover to the PCI connector or the PCI Express connector.
- [3] Insert an extension board for the connector of the extension slot horizontally while pushing the both ends of an extension board.
- [4] Push directly above the connector terminal of an extension board and insert an extension board completely.
- [5] Fix an extension board or a slot cover to the extension slot with a screw.
- [6] Attach the cover of the equipment.

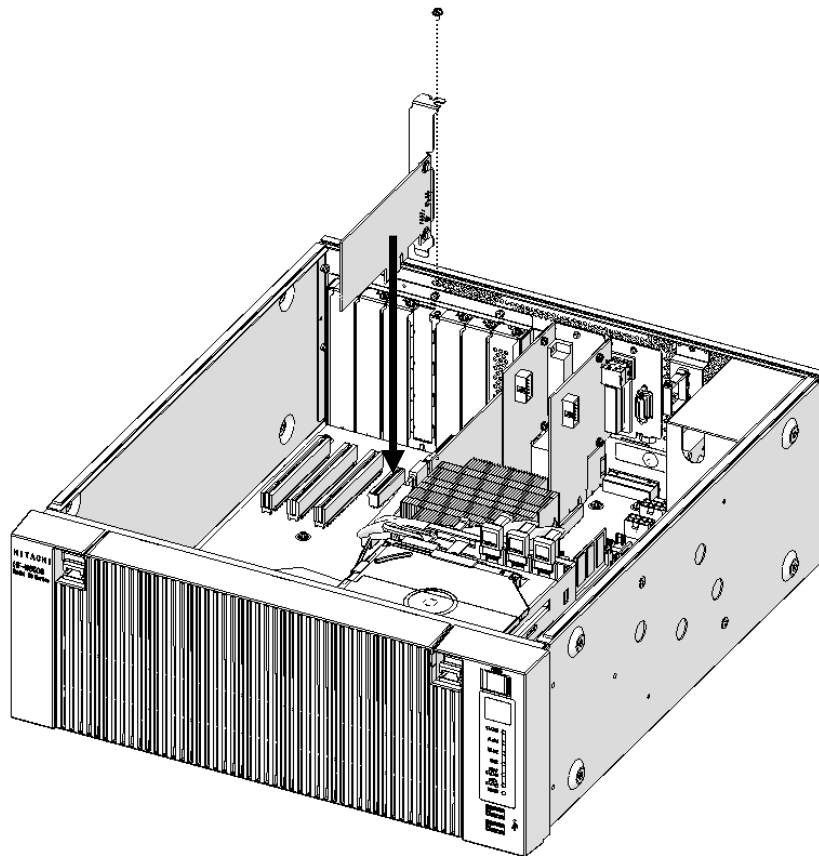

Figure 6-3 Installing an extension board

< NOTE >

When you install an extension board, the boards next to it may get knocked loose. Check that those boards are inserted properly just to be sure.

6.3.5 Installing and removing a main memory



WARNING

Before you install or remove main memory, make sure you shut down the OS, unplug the power cord from the outlet, and wait for at least one minute. If you install or remove main memory without shutting down the power, an electric shock or a fire may result.

NOTICE

Make sure you disconnect all external cables connected to the equipment before you install or remove main memory. Otherwise, failure of the equipment may result.

(1) Before installing or removing a main memory

- Before starting to work, see “6.3.2 Before installing or removing components”.
- For information about the location of the main memory slots, see “Figure 6-5 Installing a main memory”.
- Before installing or after removing the main memory module, place the tip of the vacuum cleaner nozzle on the top of the connector where the main memory module is (was) installed and clean the connector three times along the connection part.

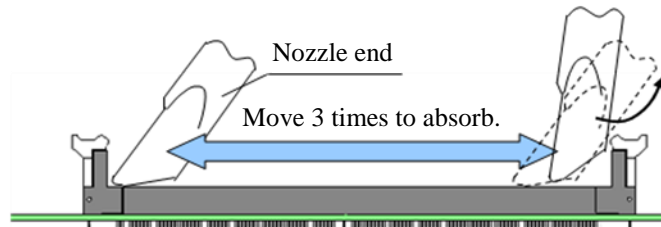

(2) Installing a main memory**NOTICE**

- The orientation of a main memory module on a connector is fixed. When you install a main memory module, make sure the orientation is correct. Otherwise, failure of the equipment may result.
- Do not install main memory modules with different capacities on slot A2 and slot B2. If you do, the modules may not be recognized.

[1] Follow the instructions in “6.3.3 Installing and removing the cover of the equipment” to remove the cover of the equipment.

[2] Refer to the figure below and remove the SATA cables from the backboard connectors.

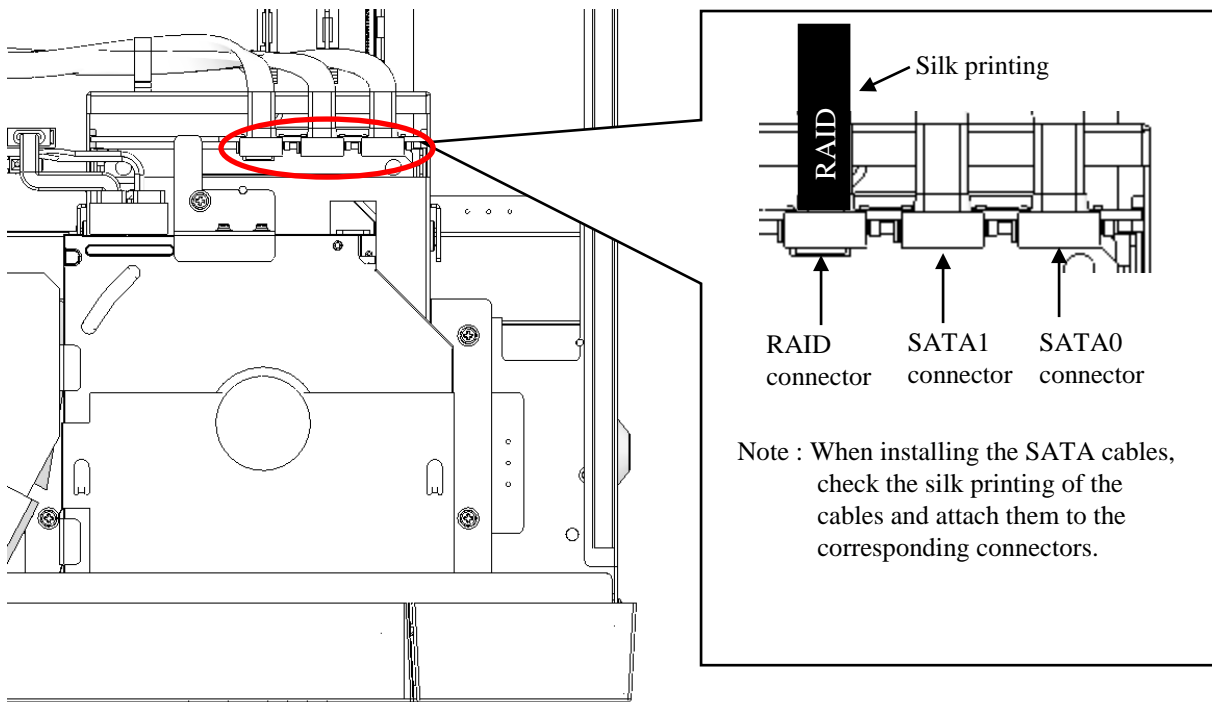

Figure 6-4 Removing the SATA cables

6. CHECKUP AND MAINTENANCE

[3] Make sure the lock on both ends of the connector of the memory slot is open.

[4] Insert the main memory into the connector from directly above the connector.

When the main memory is inserted, you will hear a click and it is locked. Make sure the lock is completely closed.

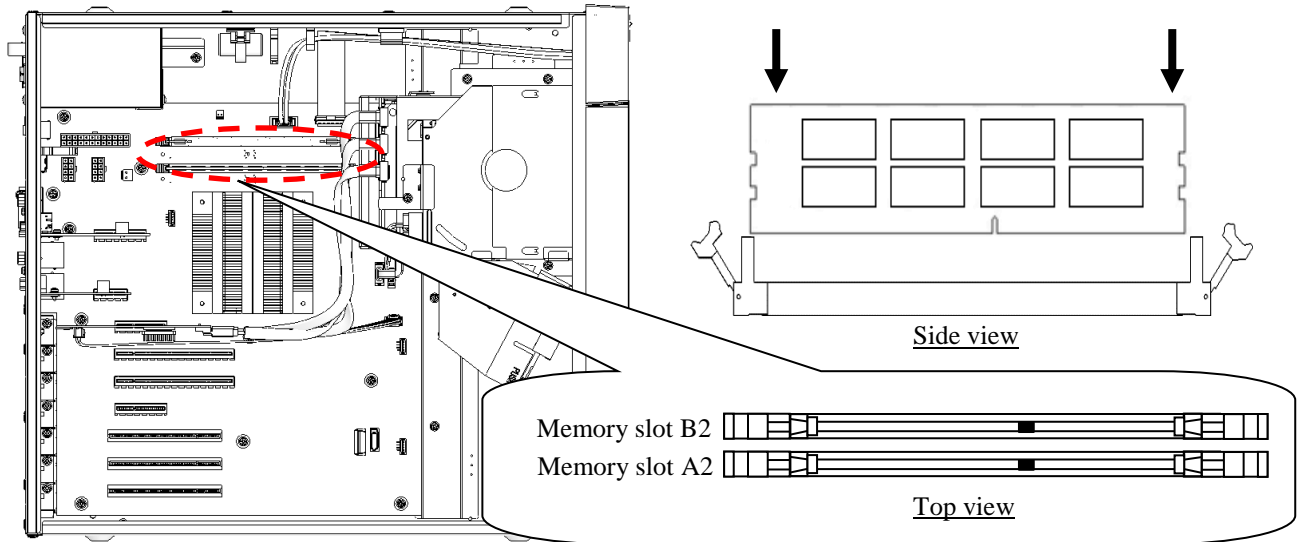

Figure 6-5 Installing a main memory

On this equipment, only the following combinations are allowed.

Table 6-3 Main memory combination list

The number of main memory	Memory slot A2	Memory slot B2	Total capacity
2	4GB	4GB	8GB
2	8GB	8GB	16GB
2	16GB	16GB	32GB

(3) Removing main memory

Follow the procedure described in “(2) Installing a main memory” in reverse to remove main memory. Also, be careful when opening locks at both ends of the connector of the memory slot at the same time, a main memory will be disconnected from the memory slot.

(4) Reconfiguring the memory dump file settings

When you change the capacity of main memory, you must reconfigure the memory dump collection settings.

When you reconfigure the memory dump collection setting, see “8.2.1 Memory Dump Confirmation Messages” for details.

6.3.6 Installing and removing an HDD



CAUTION

When you install or remove a HDD, make sure you do not cut your fingers on the protrusions.

NOTICE

- Put the HDD on a shock-absorbing material such as an antistatic cushion even for a temporary task. If you put an HDD directly on a hard surface such as a desktop, a failure or a shorter life span of the unit or loss of data may result due to possible jarring or shock.
- Never remove the screws on an HDD while the power to the unit is on. Never hot-swap HDDs. If you do either of these, failure of the equipment or the drive may result.
- Before you replace an HDD, make sure you shut down the OS, unplug the power cord from the outlet, and wait for at least one minute.
- When you replace an HDD to recover from a failure in one HDD with the power of the equipment turned on, see “10.4.2 Recovery from a failure in one HDD”.
- Install or remove an HDD only if necessary, for example, when you need to replace an HDD due to failure. If you do it frequently, failure of the equipment may result.
- Fully insert an HDD. Loose contact and missing screws may result in failure.
- Do not give a shock to an installing HDD and the already mounted HDD during installing. If you give a shock to an HDD, failure of the drive may result.

(1) Before mounting or removing HDD

- Before starting to work, see “6.3.2 Before installing or removing components”.

< NOTE >

For information about the precautions for the HDDs, see “PRECAUTIONS 4. HARD DISK DRIVES (HDD)s”.

(2) Removing an HDD

- [1] Push down on the two claws on the left and right, and open the front cover.
- [2] Loosen two set screws for the Drive case.
- [3] Hold two set screws for the Drive case and pull out the case.

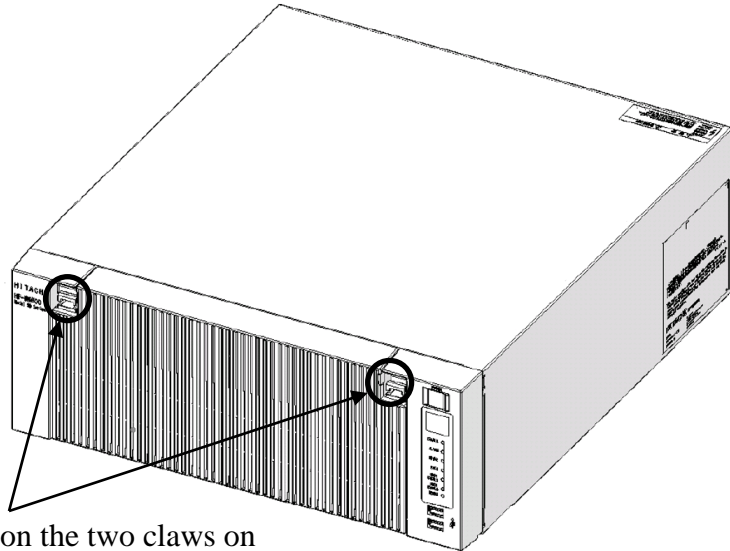

Push down on the two claws on the left and right, and open the front cover.

Figure 6-6 Opening the front cover

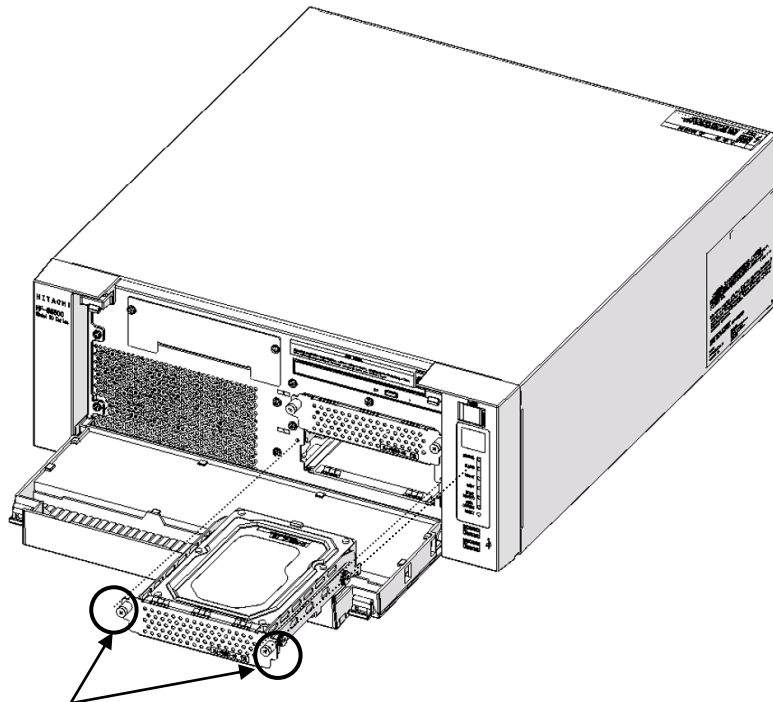

Set screws for the Drive case.

Figure 6-7 Removing an HDD

(3) Installing an HDD

Follow the procedure described in “(2) Removing an HDD” in reverse to install an HDD.

< NOTE >

- When you pull out an HDD, make sure you do not apply too much force to the connector. Slowly pull out the hard disk in order not to subject the HDD.
- When you connect an HDD to a connector, do not subject the HDD to shock or jarring.
- Always install the system disk in drive bay 1. Even if the system disk is incorrectly installed in the drive bay 2, the OS will start up, so pay attention to the mounting position of the disk.
- The capacities of HDD1 and HDD2 must be the same. Do not install HDDs with different capacity.
- After having closed front cover, please confirm that you are locked. Front cover may open by a shock.

6.3.7 Installing and removing a DVD drive

 CAUTION

When you install or remove a DVD drive, make sure you do not cut your fingers on the protrusions.

NOTICE

Make sure you do not apply too much force to the connector of the DVD drive and the top of the DVD drive. If you do so, failure of the DVD drive may result.

(1) Before installing or removing a DVD drive

- Before starting to work, see “6.3.2 Before installing or removing components”.

(2) Removing a DVD drive

- [1] Follow the instructions in “6.3.3 Installing and removing the cover of the equipment” to remove the cover of the equipment.
- [2] Follow the instructions in “6.3.6 Installing and removing an HDD” to open the front cover.
- [3] Remove the fixed claw of the DVD cover.
- [4] Slide the DVD cover in the direction of the arrow.
- [5] Remove it by expanding the DVD cover to the outside.

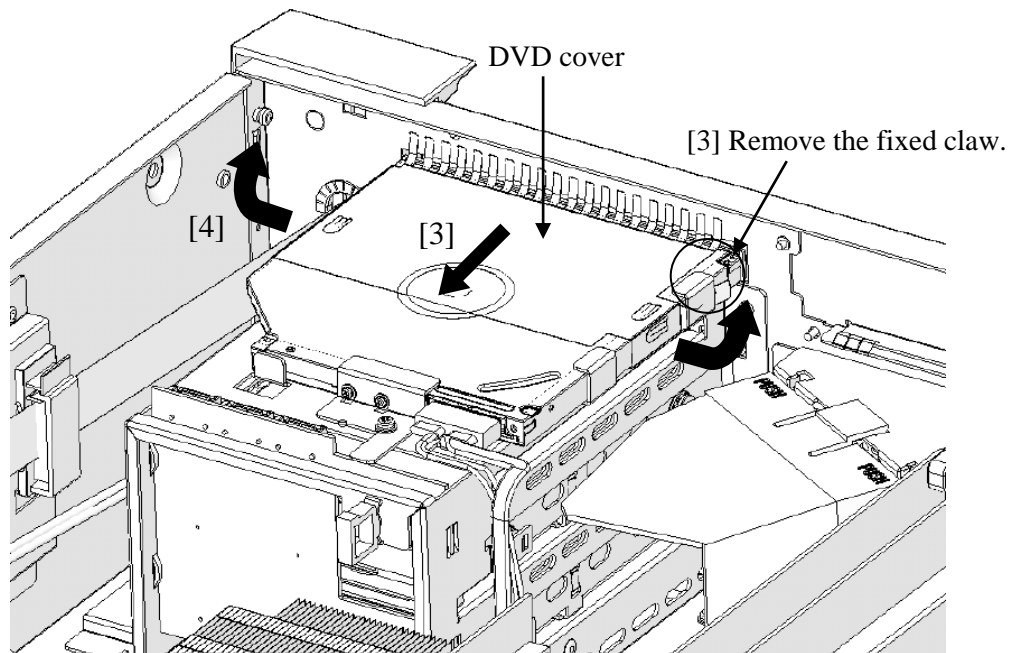

Figure 6-8 Removing a DVD cover

- [6] Remove the screw fixing the equipment and the DVD drive.
 (Use a Phillips screwdriver JIS #1)

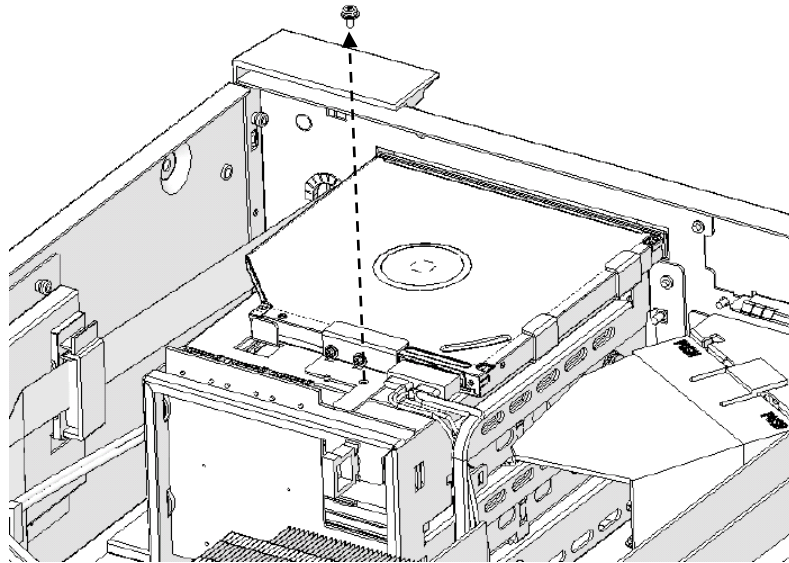

Figure 6-9 Removing the screw fixing the DVD drive

- [7] Pull the DVD drive lightly toward the front of the equipment and remove the DVD drive cable from the DVD drive.
 [8] Remove the DVD drive from the equipment.

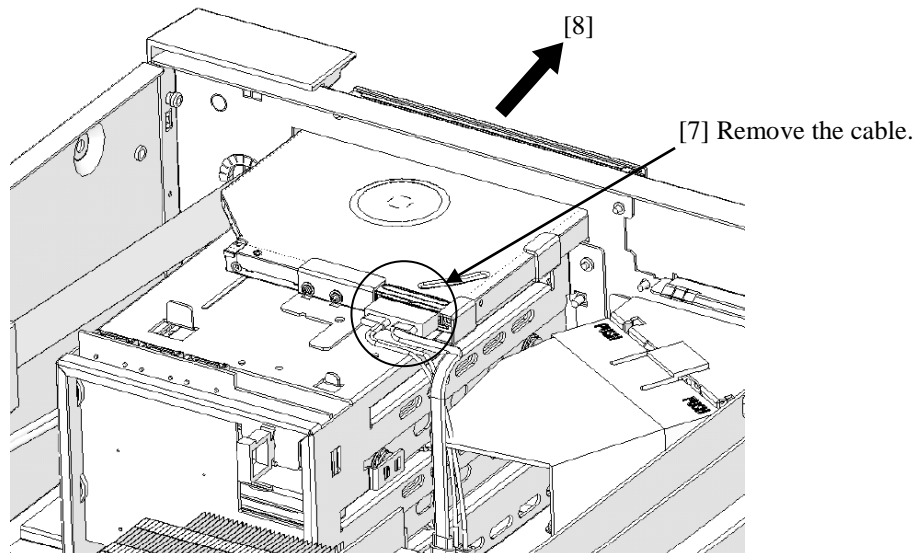

Figure 6-10 Removing the DVD drive

(3) Installing a DVD drive

Follow the procedure described in “(2) Removing a DVD drive” in reverse to installing a DVD drive.

6.3.8 Attaching and removing rack-mounting metal fittings (option)



CAUTION

- Rack-mounting metal fittings are designed to be used for pulling out the equipment toward the front by hooking your fingers on the handles. Do not grip the handles to lift up or carry the equipment. If you do, the equipment may fall and personal injury may result.
- Thoroughly check if the rack-mounting metal fittings are attached properly. If they are not attached properly or the screws are loose, the equipment may fall and personal injury may result.

NOTICE

The orientation of a rack-mounting metal fitting is fixed if it is to be attached to the equipment. Make sure the orientation is correct.

(1) Before attaching or removing rack-mounting metal fittings

- Before starting to work, see “6.3.2 Before installing or removing components”.

< NOTE >

- For information about the precautions for rack-mounting metal fittings, see “PRECAUTIONS 8. RACK-MOUNTING METAL FITTINGS”.

(2) Attaching rack-mounting metal fittings

- [1] Follow the instructions in “6.3.3 Installing and removing the cover of the equipment” to remove the cover of the equipment.
- [2] If the rack-mounting metal fittings came with the equipment, use the screws that also came with the equipment to attach the rack-mounting metal fittings.

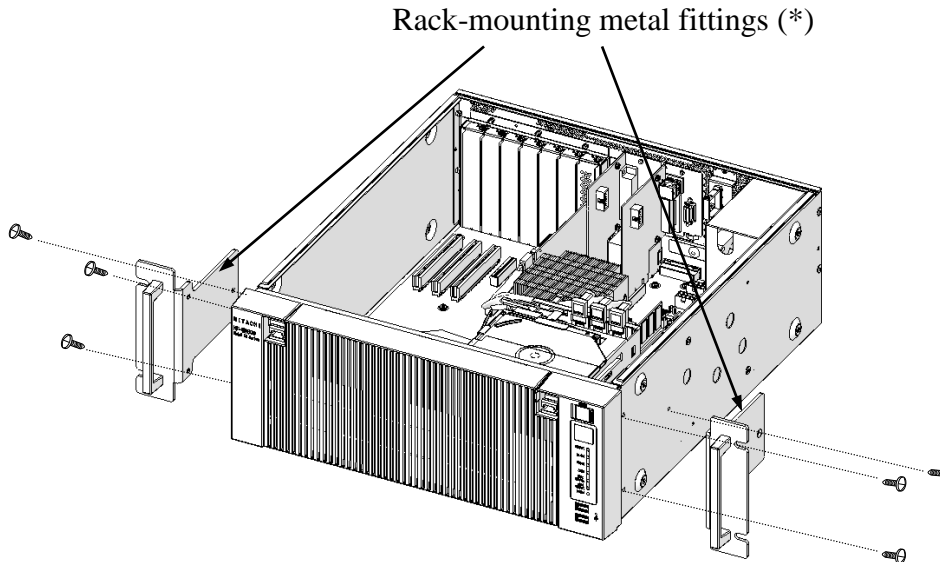

- (*) L or R is indicated on the external side of a rack-mounting metal fitting. As seen from the front of the equipment, attach the one with L on the left side of the equipment and the one with R on the right.

Figure 6-11 Attaching Rack-Mounting Metal Fittings

- [3] Follow the instructions in “6.3.3 Installing and removing the cover of the equipment” to install the cover of the equipment.

(3) Removing rack-mounting metal fittings

Follow the procedure for attaching rack-mounting metal fittings in reverse to remove them.

6.3.9 Attaching and removing rubber feet

(1) Before attaching and removing rubber feet and cover screws

- Before starting to work, see “6.3.2 Before installing or removing components”.

(2) Removing rubber feet

- [1] Insert the blade of a slotted screwdriver into the center part of a mounted rubber foot.
- [2] Gradually pry up the cap at the center of the rubber foot by gently pushing the handle of the driver toward the bottom plate of the equipment.

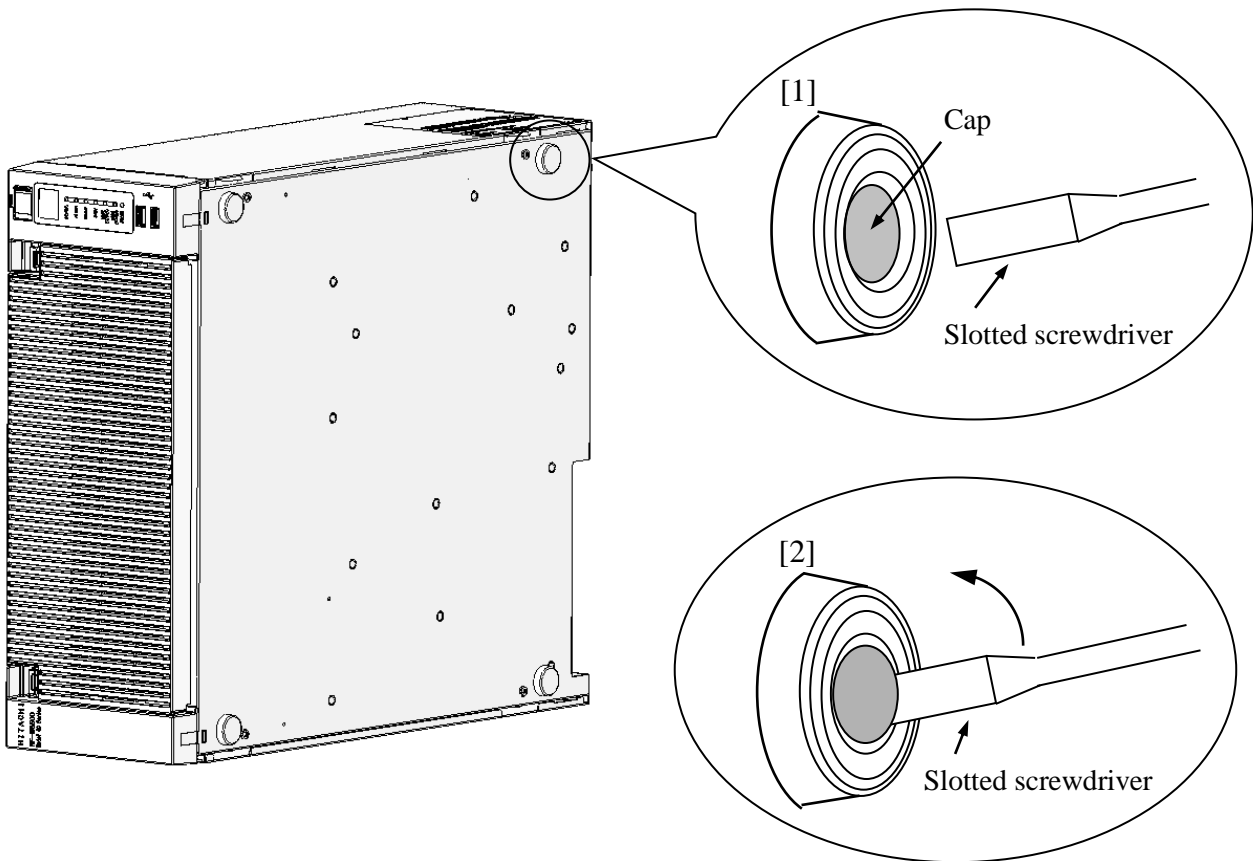

Figure 6-12 Removing a Rubber Foot

(3) Removing cover screws

[1] Remove the four cover screws using a Phillips screwdriver.

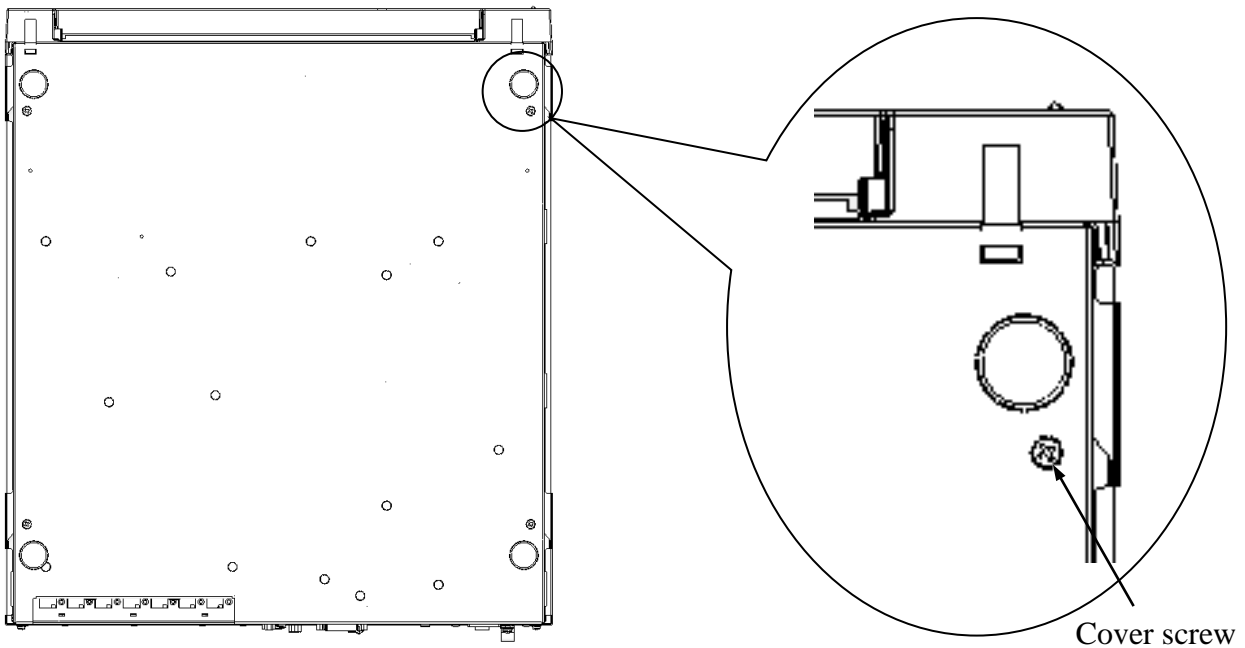

Figure 6-13 Removing cover screws

< NOTE >

- Save the rubber feet, and keep them in a safe place for later use.

**CAUTION**

When you install the equipment on the mounting metal fitting for vertical installation, do not use set screws for the cover to secure the equipment. If you use the set screws for the cover, the equipment may fall and personal injury may result.

(4) Installing rubber feet and cover screws

Align the rubber feet with the holes on the bottom of the equipment and push down the cap at the center of each rubber foot.

6.3.10 Replacing a dust filter

 **WARNING**

Make sure to install a dust filter to equipment. If you do not, dusts enter into the equipment and the short circuit fire may occur as a result.

- [1] Follow the instructions in “6.3.6 Installing and removing an HDD (2) Removing an HDD” to open the front cover.
- [2] Remove the dust filter from the front cover.
- [3] When you install a dust filter, follow the above procedure in reverse.

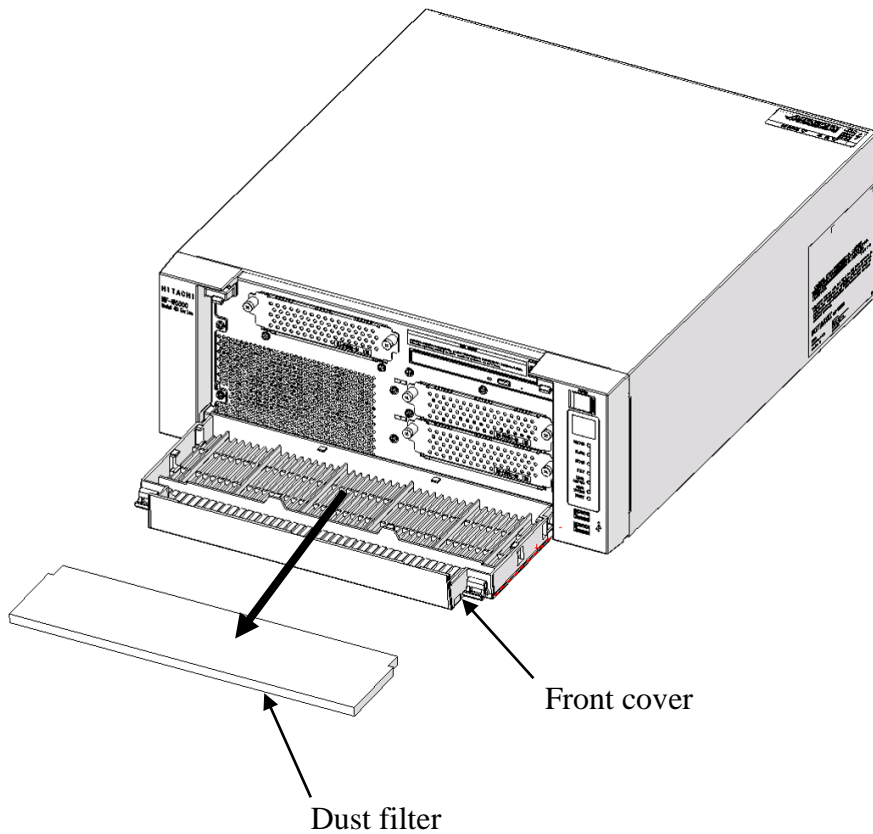

Figure 6-14 Replacing a dust filter

6.4 Installing and removing a lithium battery



CAUTION

- This equipment uses a lithium battery. When you replace the lithium battery, make sure you replace it with one specified by the Manufacture. Otherwise, an explosion, a fire, a burst battery, heat generation, a liquid spill, or gas generation may result.
- Install the battery in correct polarity. Installing it in wrong polarity may cause abnormal reaction such as charging or shorting, resulting in a liquid spill, heat generation or a burst battery.

(1) Before removing a lithium battery

- Before starting to work, see “6.3.2 Before installing or removing components”.

< NOTE >

Before replacing the battery, make sure you record the BIOS settings. Restore the BIOS settings after you replace the battery. It should be noted that the system clock is initialized when you replace the battery. Configure the system clock after the replacement.

(2) Removing a lithium battery

- [1] Follow the instructions in “6.3.3 Installing and removing the cover of the equipment” to remove the cover of the equipment.
- [2] Remove the lithium battery from the battery holder as shown in the figure below.
- [3] Remove the lithium battery from the BAT connector on the motherboard.

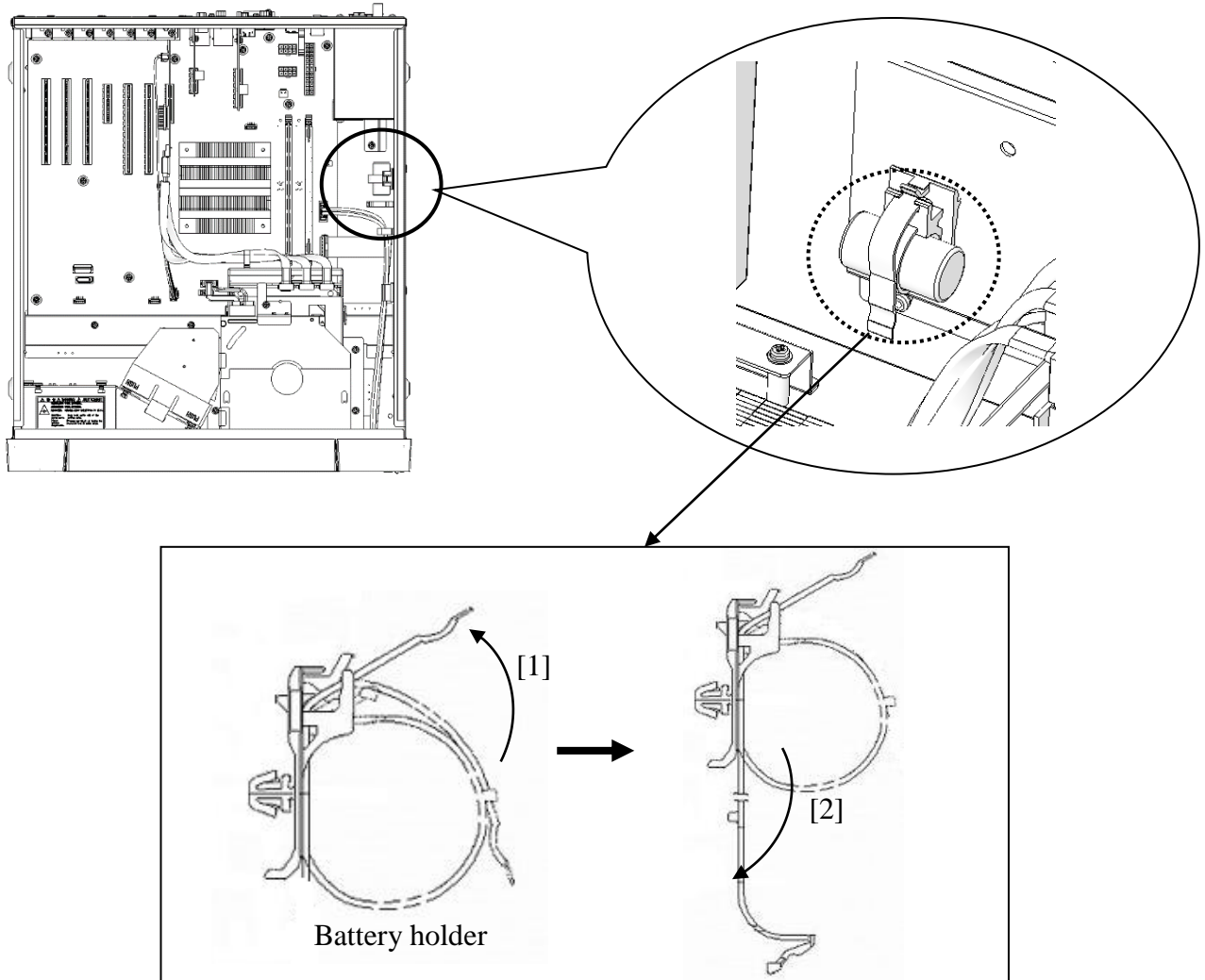

Figure 6-15 Removing a lithium battery

(3) Installing a lithium battery

When you install a lithium battery, follow the above procedure in reverse.

< NOTE >

When you connect a cable, make sure the orientation of the cable is correct and insert the connector without applying too much force on the connectors.

6.5 Enabling the Remote Power On Function



CAUTION

Do not directly touch the parts inside the equipment with your hand when you install or remove a jumper socket. Those parts are hot and if you touch them, you may get burned. In addition, if you touch them, they may get damaged and that may result in failure of the equipment.

When you use the remote power on function of the optional RAS external control port, remove the jumper socket attached to the JP2 pins on the motherboard. Whether a jumper socket is attached determines whether the function of the external contact GENDI2 is a general-purpose digital input signal or the remote power on signal. (See “5.9.2 External control specifications”.)

Table 6-4 Remote Power On setting

Whether a jumper socket is attached	GENDI2 setting
Attached	General-purpose digital input signal
Not attached	Remote power on signal

(1) Before attaching or removing a jumper socket

- Before starting to work, see “6.3.2 Before installing or removing components”.

(2) Removing a jumper socket

- [1] Follow the instructions in “6.3.3 Installing and removing the cover of the equipment” to remove the cover of the equipment.
- [2] When removing the jumper socket, follow the instructions in “6.3.4 Installing and removing an extension board” to remove an extension board if the extension board is interfered with the work.
- [3] Remove the jumper socket from the JP2 pin. (The JP2 pin is located on the straight line of the slot 5 connector.)

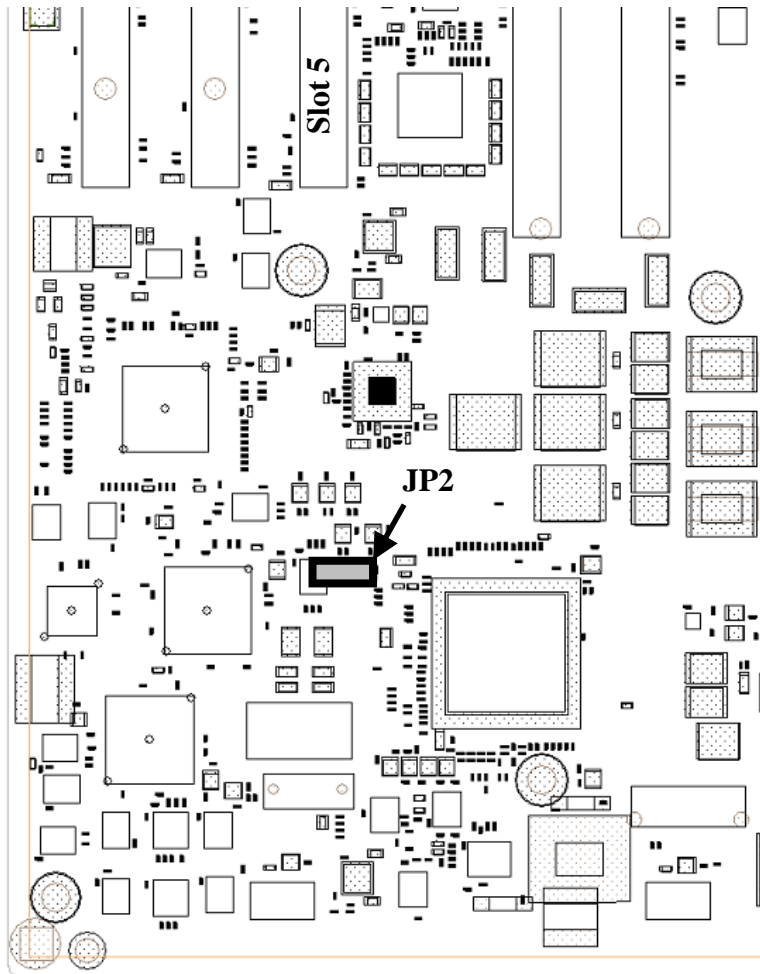

Figure 6-16 Removing a Jumper Socket

(3) Attaching a jumper socket

Follow the procedure described in “(2) Removing a jumper socket” in reverse to attaching the jumper socket.

< NOTE >

Save the jumper socket in a safe place for later use when you want to restore the original setting.

CHAPTER 7 RESTORING THE FACTORY-SHIPPED CONDITION USING A RECOVERY DVD

NOTICE

A recovery DVD contains an image file created for the hardware configuration at the factory shipment. If the hardware configuration has changed from the one at the factory, the OS may not start after restoration work. Remove all external storage devices to resume the hardware configuration at the factory shipment before you perform restoration work using a recovery DVD.

When a recovery DVD is used, all data in the system drive is deleted. Back up the data beforehand as required.

This chapter describes the following procedure:

- The procedure to restore the system drive back to the factory-shipped conditions when you discontinue the system you have built.

7.1 Overview of Restoration Procedure

This section describes the overview of the procedure to restore the system drive back to the factory-shipped condition when you discontinue the system you have built. After you restore the contents of the system drive back to the factory condition, follow the procedure described in “CHAPTER 3 SETUP” to set up the OS.

The following is a rough flow chart of the procedure.

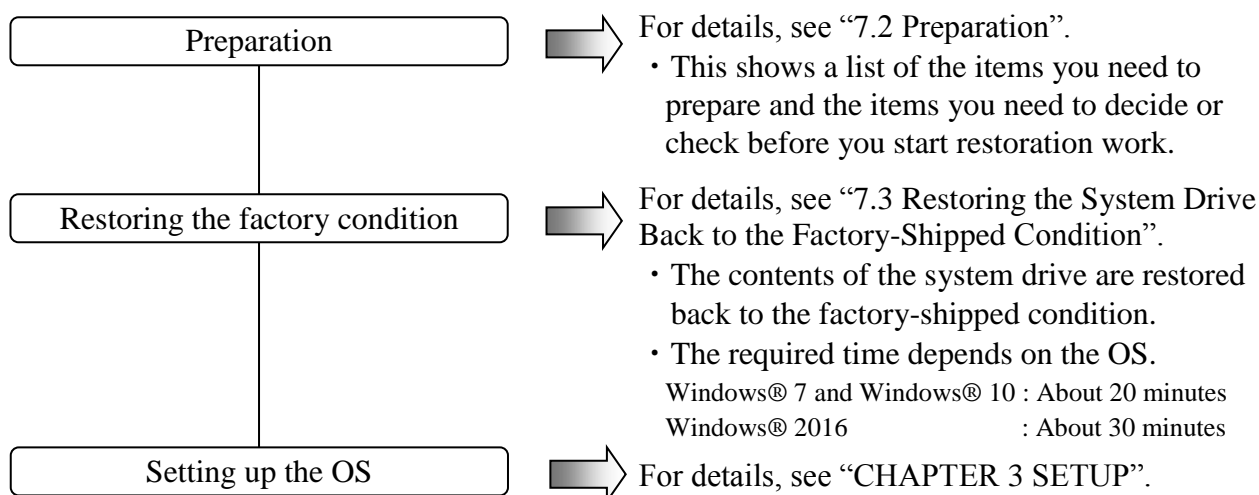

7. RESTORING THE FACTORY-SHIPED CONDITION USING A RECOVERY DVD

7.2 Preparation

Before you start restoration work using recovery DVDs, have the following recovery DVDs ready.

Recovery DVD for HF-W	HITACHI <u>HJ-7550-****</u> Product Recovery DVD (The underlined part is the model number of the equipment you purchased.)
--------------------------	---

7.3 Restoring the System Drive Back to the Factory-Shipped Condition

7.3.1 Procedure for restoring the system drive back to the factory-shipped condition

Follow the procedure below to restore the system drive of an HF-W7500 Model 50 back to the factory-shipped condition using a recovery DVD.

1. Turn on the power to the equipment, and insert a recovery DVD “HITACHI HJ-7550-**** Product Recovery DVD” to the DVD drive. If the number of recovery DVDs is multiple, insert a first disc (For example, if the number of recovery DVDs two insert the disc number : 1/2).

(Note) The underlined part is the model number of the equipment you purchased, and therefore the part indicated as * is different depending on the model. In the following description of the procedure, replace the “HJ-7550-****” with the actual model number of the equipment you purchased.

2. When you boot from the recovery DVD, the confirmation message is displayed.

(Note) If you cannot boot from the recovery DVD, turn off the equipment, and then turn it back on.

- When the model name displayed in the confirmation message is the same as the model name of the equipment you use, click **Yes**.
- When the model name displayed in the confirmation message is different from the model name of the equipment you use, click **No**.

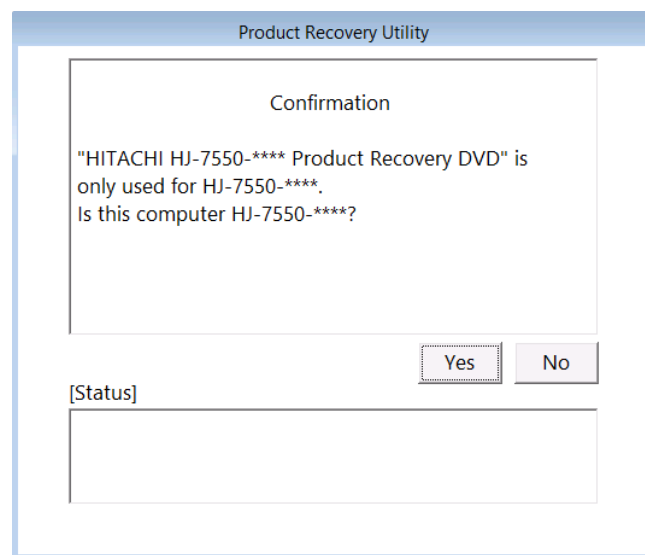

7. RESTORING THE FACTORY-SHIPED CONDITION USING A RECOVERY DVD

When you click **No**, the following message box is displayed. Click **OK**.
The recovery DVD is automatically ejected, and then the equipment is automatically shut down.
If you want to go back to the confirmation window for the attention message, click **Cancel**.

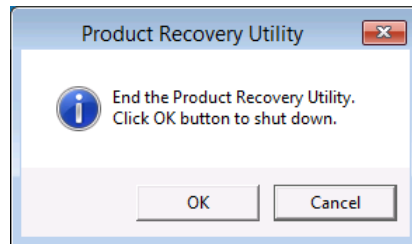

3. When you click **Yes** on the confirmation message window, the confirmation window for the following attention message is displayed.
- If you are OK with the attention message, click **Yes**.
 - If you are not OK with the message, click **No**.

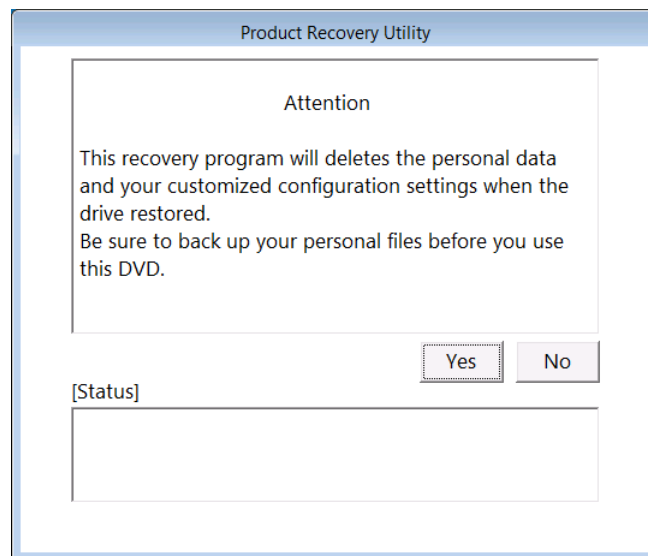

When you click **No**, the following message box is displayed. Click **OK**. The recovery DVD is automatically ejected, and then the equipment is automatically shut down.
If you want to go back to the confirmation window for the attention message, click **Cancel**.

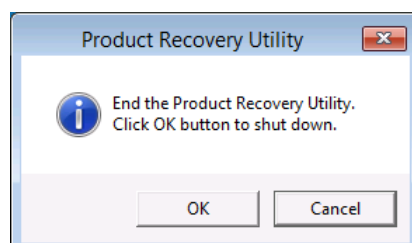

4. When you click **Yes** on the confirmation window for the attention message, the selection window for the drive restore option is displayed.

- If you want to restore the system drive back to the factory-shipped condition, select the restore option, and then click **Next**.
- If you want to cancel restoring the system drive back to the factory-shipped condition, click **Cancel**.

- **Entire drive:**

Select this option if you want to restore the whole system drive back to the factory-shipped condition or configure a new drive to the factory-shipped condition after you replace the system drive.

If you select this option and click **Next**, proceed to step 5.

- **Only the system and boot partition:**

Select this option if the system drive has partitions other than the boot partition (the partition on which Windows is installed) for data storage or other purposes and you want to restore the system drive back to the factory-shipped condition while keeping these partitions. If you select this option, only the boot partition is restored back to the factory-shipped condition.

If you select this option and click **Next**, proceed to step 6.

You cannot select this option in the following cases.

- The system drive has no boot partitions.
- The system drive has more than one boot partition.
- The size of the boot partition is less than the minimum boot partition size defined for this equipment.

(For an HF-W7500 Model 50, the minimum size is 100 GB.)

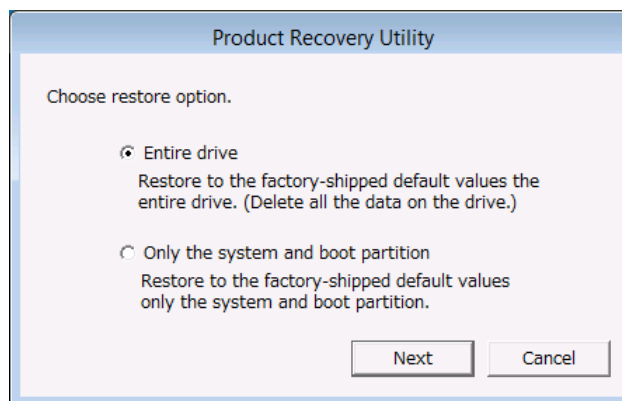

7. RESTORING THE FACTORY-SHIPED CONDITION USING A RECOVERY DVD

When you click **Cancel**, the following message is displayed. Click **OK**. The recovery DVD is automatically ejected, and then the equipment is automatically shut down.

If you want to go back to the selection window for the drive restore option, click **Cancel**.

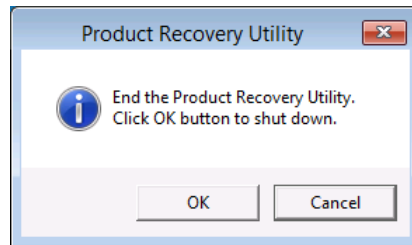

7. RESTORING THE FACTORY-SHIPED CONDITION USING A RECOVERY DVD

<When you select **Entire drive** in the selection window for the drive restore option>

5. If you select **Entire drive** in the selection window for the drive restore option, the confirmation window for the settings of the drive restoration is displayed.

- If you are OK with the displayed partition size to be restored, click **Yes**. Proceed to step 7.
- If you are not OK with the displayed partition size to be restored, click **No**. The selection window for the drive restore option returns.

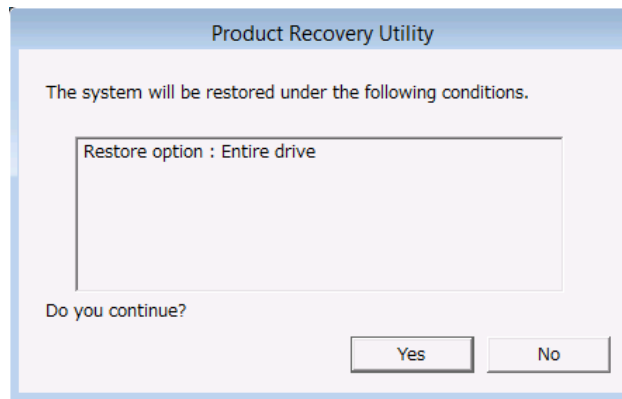

<When you select **Only the system and boot partition** in the selection window for the drive restore option >

6. If you select **Only the system and boot partition** in the selection window for the drive restore option, the confirmation window for the settings of the drive restoration is displayed.

- If you are OK with restoring only the boot partition, click **Yes**. Proceed to step 7.
- If you are not OK with restoring only the boot partition, click **No**. The selection window for the drive restore option returns.

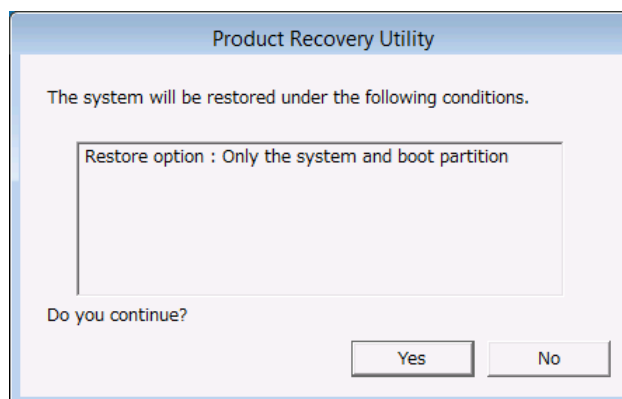

7. RESTORING THE FACTORY-SHIPED CONDITION USING A RECOVERY DVD

7. When you click **Yes** in the confirmation window for the settings of the drive restoration, a restoration process for the drive starts. The progress is displayed in the **[Status]** box. The following picture is an example that the number of recovery DVDs is two.

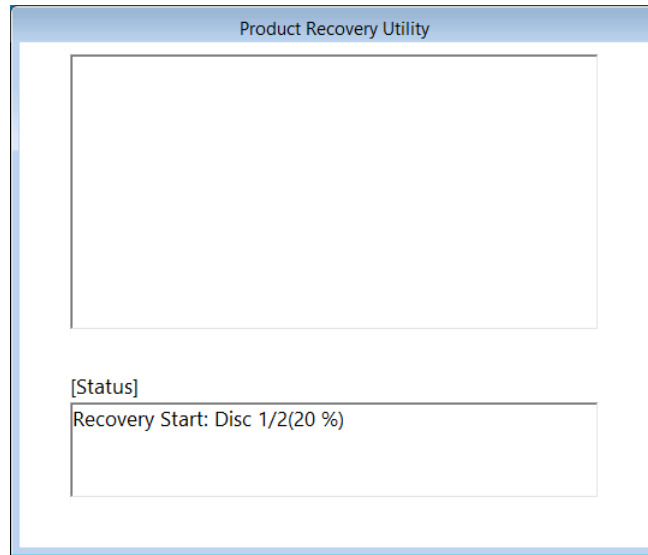

(Note) If you select **Only the system and boot partition** in the selection window for the drive restore option, the boot partition is formatted before the restoration process. Formatting the partition may take up to a couple of minutes. (The time required for formatting depends on the size of the boot partition.) During the format process, "Preparing Recovery." is displayed in the **[Status]** box.

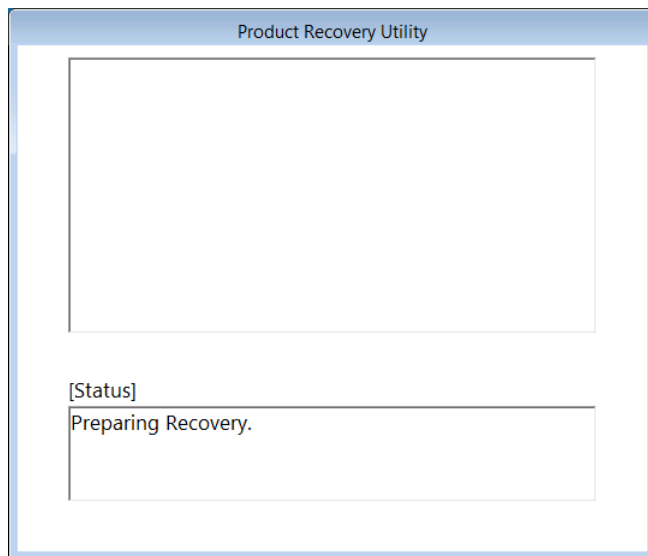

7. RESTORING THE FACTORY-SHIPED CONDITION USING A RECOVERY DVD

8. In the case of the number of recovery DVDs is multiple, when the restoration process back to the factory-shipped condition performed by the current recovery DVD, the following message is displayed, and the recovery DVD is automatically ejected. Remove the recovery DVD from the DVD drive, and insert the next recovery DVD. The following picture is a example that the number of recovery DVDs is two.

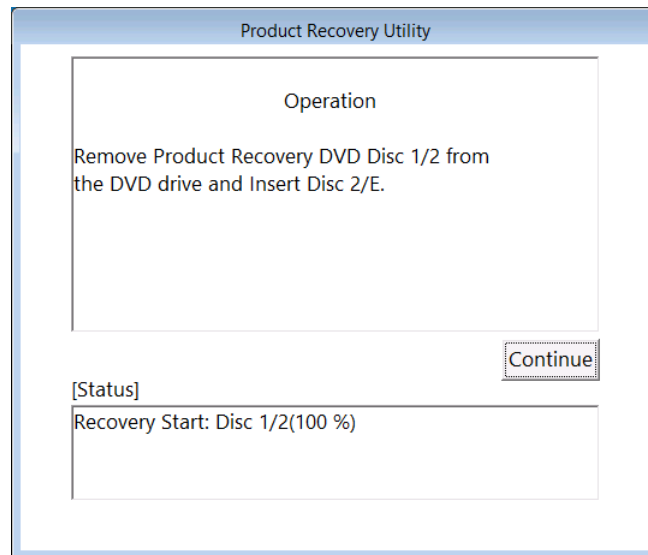

9. When you click **Continue**, it is displayed "Preparing Recovery. Please wait a few minutes." in the **[Status]** box. Then, the restoration process back to the factory-shipped condition resumes and the progress is displayed in the **[Status]** box.

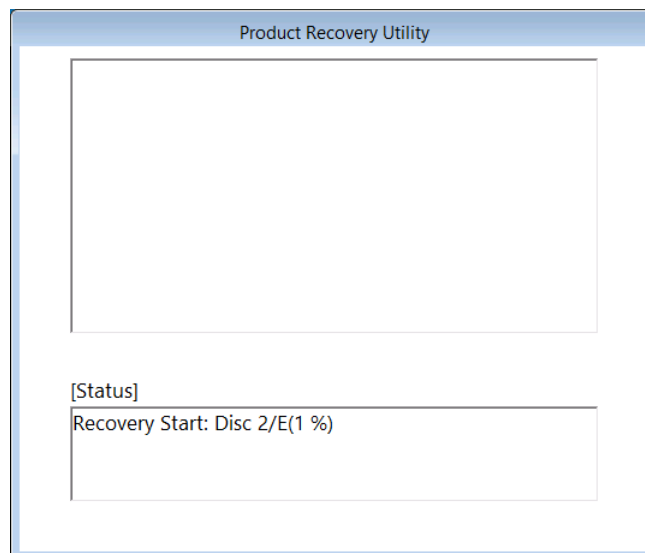

10. If the number of recovery DVDs is multiple, repeat steps 8 and 9.

7. RESTORING THE FACTORY-SHIPED CONDITION USING A RECOVERY DVD

11. When the restoration process back to the factory-shipped condition performed by the recovery DVD is fully completed, “Recovery Complete.” is displayed in the **[Status]** box, and the recovery DVD is automatically ejected. Remove the recovery DVD from the DVD drive, and then click **Exit**. The equipment will be shut down.

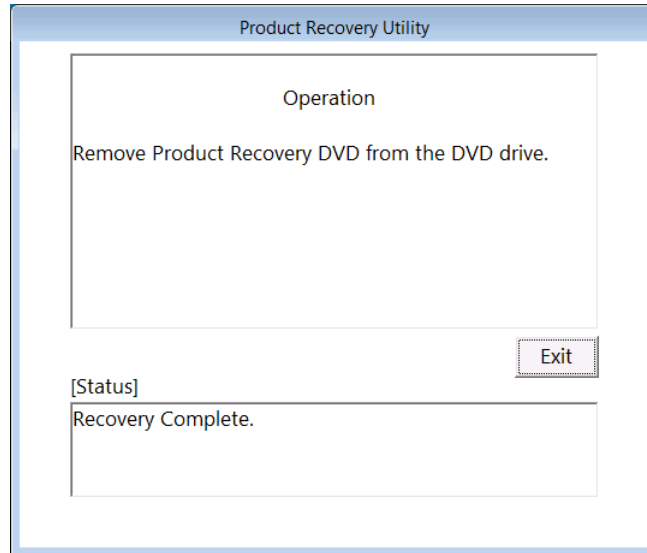

The system drive of the HF-W7500 Model 50 is now successfully restored to the factory condition by using a recovery DVD. After you finish the procedure above, follow the instruction in “CHAPTER 3 SETUP” to set up the OS.

7.3.2 Errors generated during a restoration process and their corrective actions

When an error occurs during a restoration process, record the error message and the error code displayed on the window, and take actions as shown in the following table. If you take the actions accordingly but cannot let the recovery process go through or if the No. 8 error message is displayed, contact our sales representative.

Table 7-1 List of errors of the recovery operation

No.	Error message	Action
1	Retry time out. Please refer to the INSTRUCTION MANUAL.	<ul style="list-style-type: none"> • Check the integrity of the system drive. (Read/Write tests and so on)
2	Image file is not found. Please refer to the INSTRUCTION MANUAL.	<ul style="list-style-type: none"> • Retry a recovery process. • Check the integrity of the recovery DVD. (Read tests and so on) • Check if the DVD drive works properly. (Read tests and so on)
3	Drive failed or not connected. Please refer to the INSTRUCTION MANUAL.	<ul style="list-style-type: none"> • Check if the system drive is connected correctly.
4	Failed to access the drive. Please refer to the INSTRUCTION MANUAL.	<ul style="list-style-type: none"> • Check the integrity of the system drive. (Read/Write tests and so on)
5	Failed to assign drive letter. Please refer to the INSTRUCTION MANUAL.	<ul style="list-style-type: none"> • Check that any devices unnecessary for a recovery process are connected. If connected, remove them.
6	Failed to read from Product Recovery DVD. Please refer to the INSTRUCTION MANUAL.	<ul style="list-style-type: none"> • Check if the DVD drive is connected correctly. • Check the integrity of the recovery DVD. (Read tests and so on) • Check if the DVD drive works properly. (Read tests and so on)
7	Recovery failed. Please refer to the INSTRUCTION MANUAL.	<ul style="list-style-type: none"> • Retry a recovery process.
8	Recovery invalid. Please refer to the INSTRUCTION MANUAL.	<ul style="list-style-type: none"> • Contact our sales representative.
9	Drive capacity is not enough. Please refer to the INSTRUCTION MANUAL.	<ul style="list-style-type: none"> • Check the size of the system drive.

This Page Intentionally Left Blank

CHAPTER 8 MAINTENANCE OPERATIONS

This chapter describes maintenance operations that use the Reliability, Availability, and Serviceability (RAS) features of this equipment.

8.1 Overview

RAS features are designed to achieve highly reliable features of the equipment. The following table shows an overview of the RAS features of this equipment.

Table 8-1 RAS features overview

Category		Item
Monitoring		Hardware status monitoring
		OS hangs monitoring
		Watchdog timer monitoring
GUI features setting		RAS features setting window
Status check	GUI display	Hardware status window
	Notification	Event notification
		Pop-up notification
		Digital LEDs for Status indication
		Remote notification
		Status acquisition by using library functions
Control	Shutdown /Startup suppression	Automatic shutdown
		Shutdown by Library functions
		Startup suppression when severe failure occurs
		Controlling general purpose external contacts
		Controlling the Digital LEDs for Status indication
Library functions		RAS library
Maintenance/ Failure analysis	Memory dump related	Memory dump collection
		Error cause notification with STOP error code
		Log information collection window
		Maintenance operation support commands
		Logging the trend of the temperature inside the chassis
Simulation		Hardware status simulation

<Monitoring>

(1) Hardware status monitoring

This function monitors the hardware status of this equipment including the status of the fans and drives as well as the temperature inside the chassis.

(2) OS hangs monitoring

This function monitors the operational state of the OS by using a dedicated timer implemented on this equipment. As long as a process with the highest priority (real-time priority class) can run properly, the status lamp on the front of this equipment is lit in green.

(3) Watchdog timer monitoring

This feature monitors whether processes are scheduled properly, using the watchdog timer implemented on this equipment. This feature also offers a library to use the watchdog timer.

<GUI feature settings>

(4) RAS setting window

This window provides a graphical user interface for configuring RAS feature settings including the condition of automatic shutdown and the setting of the watchdog timer.

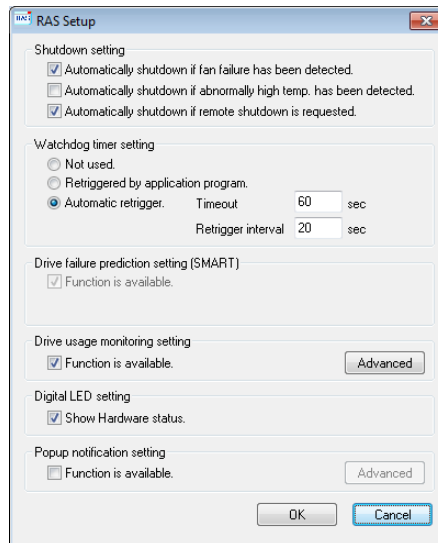

<Status check>

(5) Hardware status window

This window displays the hardware status of this equipment by using a graphical interface. There is always an icon in the notification area of the taskbar to display the hardware status.

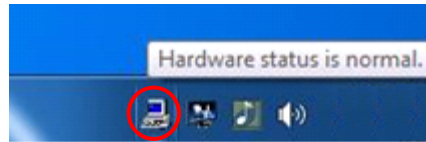

This icon is not shown in the notification area of the taskbar by default, but if you click the arrow at the side of the notification area, the icon will appear. Furthermore, if you click **Customize**, you can set this icon to be displayed in the notification area of the taskbar. (If you use the Windows® 10, right-click the arrow at the side of the notification area and click **Properties** on the menu displayed above the arrow. The **Taskbar and Start Menu Properties** window is displayed. Click **Customize** and open the **Settings** window. Then, click **Select which icons appear on the taskbar** and set **envdisp MFC Application** icon to be displayed in the notification area of the taskbar.)

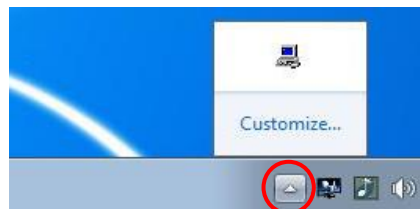
**(6) Event notification**

This feature enables a user application to check the hardware status of this equipment by monitoring the status of event objects.

(7) Pop-up notification

This feature notifies a user that an error has occurred in the hardware of this equipment by displaying pop-up messages.

(8) Digital LEDs for Status indication

The Digital LEDs for Status indication are on the front of this equipment and notify a user that an error occurred in the hardware of this equipment. These LEDs can be used by a user application in order to, for example, notify the a failure of the application.

(9) Remote notification

This feature enables a remote device to check the hardware status of the equipment. It also notifies the remote device whenever the hardware status changes.

(10) Status acquisition by using library functions

This function enables a user application to get the hardware status of this equipment by using the RAS library.

<Control>

(11) Automatic shutdown

This feature automatically shuts down the equipment when a fan failure, abnormal temperature inside the chassis, or a remote shutdown signal input is detected. Use “(4) RAS setting window” to enable or disable the automatic shutdown feature.

(12) Shutdown using library functions

You can shut down the equipment from a user application using the RAS library.

(13) Startup suppression when severe failure occurs

This feature suppresses startup of this equipment when a failure, such as a fan failure is detected during OS startup in order to protect the hardware.

(14) Control of general purpose external contacts and Digital LEDs for Status indication

This feature enables a user to control the general purpose external contacts and the status display digital LEDs with the RAS library.

Four input and three output general purpose external contacts are available. If you use those contacts, signals can be input from an external device to this equipment, and signals can be output from this equipment to an external device.

<Library functions>

(15) RAS library interface

This interface offers library functions for recording log information in addition to the library functions offered by items (10), (12) and (14).

<Maintenance / Failure analysis>

(16) Memory dump collection

This feature records the contents of the system memory in a file (memory dump file) when the reset switch is pressed after a failure has occurred, for example, after the equipment stops unexpectedly. By analyzing the data in this memory dump, you can investigate the cause of the failure.

(17) Error cause notification with a STOP error code

This feature detects a blue screen caused by an error with the STOP error code 0x80 and records the cause of the blue screen in the event log.

(18) Log information collection window

In this window you can collect log data and memory dump files for this equipment using a graphical user interface.

(19) Maintenance operation support commands

These commands include a command used for saving failure information such as memory dump files and event log files to an external medium.

(20) Trend logging of the temperature inside the chassis

This feature periodically measures the temperature inside the chassis of this equipment and records the data in a file.

<Simulation>

(21) Hardware status simulation

This feature simulates the hardware status of this equipment including the status of the fans and drives as well as the temperature inside the chassis. By using this feature, you can test a user application without an actual hardware failure.

This manual explains the features in (13), (16), and (19). For details about other features, refer to “HF-W7500 Model 50 RAS FEATURES MANUAL”. For information in (8) POST messages, see “9.6.1 POST messages”.

8.2 Collecting a Memory Dump

When one of the errors in Table 8-1 occurs, this equipment records the contents of the system memory in a file (memory dump file). Then a blue screen appears and a STOP error code is displayed. By analyzing the data in this memory dump file, you can investigate the cause of the failure.

Table 8-2 Error That Trigger a Memory Dump

Cause	Description
Forced recovery from OS hang	When the OS hangs, press the reset switch or input a remote reset signal to the external contact RMTRESET (*1). Then a memory dump is collected.
Hardware NMI	When a severe failure (such as uncorrectable memory error or a PIC bus parity check error) occurs in the hardware of this equipment, a non-maskable interrupt (NMI) is generated and a memory dump is collected.
Microsoft® Windows® STOP error	When a fatal error occurs in the Microsoft® Windows® kernel, a memory dump is collected.

(*1) Do not input a remote reset signal continuously to the RMTRESET external contact. If you do, this equipment cannot collect a memory dump.

For details about the displayed STOP error code, see “9.3 STOP Error Codes”.

To select the memory dump file type, open System in Control Panel. You can select from the following five types defined below (In the case of Windows® 7, you can select from the three types except “Automatic memory dump” and “Active memory dump”). Because the memory dump file type determines how far you can analyze the failure by using the dump file, we recommend selecting “Complete memory dump” whenever you can. The factory default is “Complete memory dump”.

- Complete memory dump : The entire contents of system memory is recorded. The boot volume (*2) must have enough free space to hold a paging file equal to the size of the physical memory plus 1 MB.
- Kernel memory dump : The kernel memory is recorded. The boot volume (*2) must have enough free space to hold a paging file about one third the size of the physical memory.
- Minimum memory dump : The minimum information necessary for identifying what caused the equipment to stop is recorded. The boot volume (*2) must have enough free space to hold a paging file of more than 2 MB.
- Automatic memory dump: Similarly to the kernel memory dump, the kernel memory is recorded. The difference from the kernel memory dump is that the Auto memory dump can make the initial paging file small from the physical memory size.
- Active memory dump : The contents of the memory assigned to a virtual machine are filtered, and the contents of the memory used in the Hyper-V hosts are recorded only. The active memory dump can make the recorded memory dump file smaller than the complete memory dump.

(*2) The boot volume is a volume that contains Windows® files and Windows® support files.

In order to collect a complete memory dump file, you need a memory dump file of a size comparable to the capacity of the physical memory. In addition, the virtual memory (page file) and memory dump settings must be the ones recommended for this equipment (*3).

(*3) This means the settings in the **Advanced system settings** in the Control Panel are as follows. These settings are preset in this equipment when the equipment is shipped from the factory.

- In the **Startup and Recovery**, **Complete memory dump** is selected as memory dump type.
- In the **Startup and Recovery**, **Overwrite any existing file** is selected.
- In the **Performance**, the **Initial size** and **Maximum size** of the virtual memory is the physical memory size plus 300MB.

When an incident occurs that triggers a memory dump or the reset switch is pressed, the process that triggers a memory dump is started after the window called “blue screen” is displayed.

< NOTE >

- The time required for collecting a memory dump depends on the type of dump file collected, the configuration of the mounted drives, and the memory capacity. It should be noted that if you keep the factory setting, “Complete memory dump”, for the memory dump file type, the time required may be extremely long.
- After “Beginning dump of physical memory” is displayed on the blue screen, the count on the screen that shows the progress of the memory dump sometimes stops being updated. This is because collection of the memory dump failed due to an error of the file system or a hard disk.
If this happens, record the first five lines of the STOP message screen. Then press the reset switch or turn the power off and then back on to restart the equipment.

8.2.1 Memory Dump Confirmation Messages

If the capacity of the physical memory exceeds the capacity of the memory dump file or the virtual memory due to, for example, newly added physical memory, or if a complete memory dump cannot be collected because the memory dump setting has changed, this equipment displays the following message and records an event in the event log.

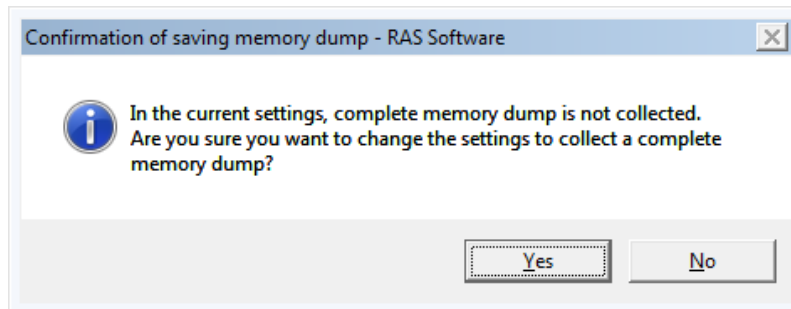

If you want to use the system with the memory dump setting recommended for this equipment, click **Yes** to close the message box. The memory dump and virtual memory settings are updated and the area for saving a memory dump is allocated automatically as required.

< NOTE >

- If you do not want to use the system with the memory dump setting recommended for this equipment, click **No** to close the message box. Then, this message box will no longer be displayed.
- When the message box above is displayed, sometimes an information log entry with Event ID 26 is recorded in the event log.

If the following message is displayed afterward to prompt you to restart the system, click **OK** to close the message box, and then restart the system.

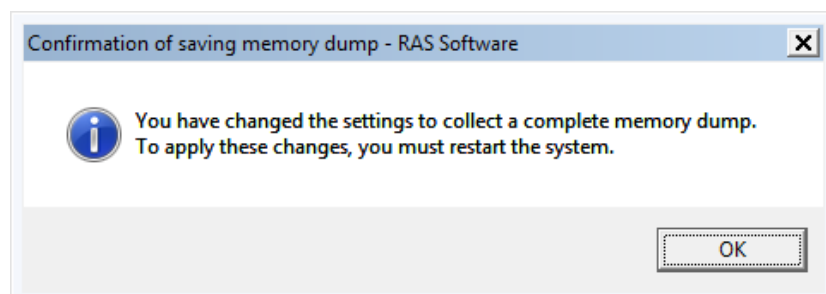

8.2.2 Configuring the settings related to a memory dump

This subsection describes how to configure the settings related to a memory dump.

Use the following procedure when you want change the memory dump setting to the one recommended for this equipment. You do not have to follow this procedure if you are already using the memory dump setting recommended for this equipment, for example, immediately after the equipment is shipped from the factory, or if you click **Yes** in " 8.2.1 Memory Dump Confirmation Messages ".

< NOTE >

Before starting a procedure in this subsection, you must log on to the local computer by using an administrator account registered on the computer (as a member of the Administrators group).

(1) Configuring virtual memory

1. Click **Start > Control Panel > System and Security**. Then click **System**.
 2. Under **Task** on the left side of the window, click **Advanced system settings**.
 3. On the **Advanced** tab page, click **Settings** under **Performance**.
 4. In the **Performance Options** window, click the **Advanced** tab.
 5. Click **Change** which is under **Virtual memory**.
 6. Clear the **Automatically manage paging file size for all drives** check box.
 7. In the **Drive** list, select the drive that stores the paging file you want to change.
For explanation, assume C: (system drive) is clicked here.
 8. Select **Custom size**. In the **Initial size (MB)** or **Maximum size (MB)** box, type the new size of the paging file in megabytes. Then click **Set**.
Specify the following value for both the initial size and the maximum size based on the physical memory size.
 - If the physical memory size is 8GB: "8223"
 - If the physical memory size is 16GB: "16415"
 - If the physical memory size is 16GB: "32799"
- You can check the physical memory size using the following procedure.
- a. Click **Start > Control Panel > System and Security**.
 - b. Click **System**. Then check the value of "Memory(RAM) : "
9. Click **OK**.

(2) Specifying a memory dump file

1. Click **Start > Control Panel > System and Security**. Then click **System**.
2. Under **Task** on the left side of the window, click **Advanced system settings**.
3. In the **Advanced** tab page, click **Settings** under **Startup and Recovery**.
4. In the **Dump file** box, type a memory dump file name.
By default, “%SystemRoot%\MEMORY.DMP” is specified for this box.
Unless it is necessary, you do not have to enter a name.
5. Select the **Overwrite any existing file** check box.
6. Click **OK**.

In order to enable a Complete memory dump as recommended for this equipment, follow the procedure below.

1. Double-click the SetCrashDump.reg file under C:\Program Files\HFWRAS\init.
2. The following message box will open. Click **Yes**.

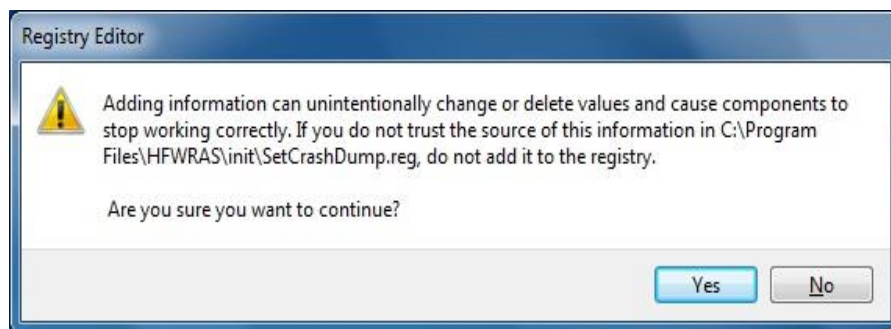

3. A message box will appear indicating that information has been added successfully.
Click **OK**.
4. The setting is applied after restart the system.

(3) Reserve the area for saving a memory dump

Reserve the area used for saving a memory dump using the createdmp command.
For details, see "8.4 Maintenance Operation Commands".

8.3 Startup Suppression on Serious Failure Detection

This equipment suppresses startup of the equipment when one of the following incidents is detected during Windows® startup in order to protect the hardware.

1. Fan failure
2. Remote shutdown signal input

< NOTE >

In the case of a remote shutdown signal input, startup is suppressed only when “Enable automatic shutdown at remote shutdown input” is selected in the RAS setting window. If an automatic shutdown is not selected, startup is not suppressed. For information about how to use the RAS setting window, refer to “HF-W7500 Model 50 RAS FEATURES MANUAL”. When a remote shutdown signal input is detected, the equipment displays a blue screen and then stops. For information about the STOP error code of this case, see “9.3 STOP Error Codes”.

8.4 Maintenance Operation Commands

This section explains how to use maintenance operation commands. These commands are used when problems occur in the equipment and during preventive maintenance. All these commands are started at the command prompt when they are used.

Table 8-3 shows a list of maintenance operation commands.

Table 8-3 Maintenance Operation Commands

Command name	Feature
logsave	Used for collecting data for preventive maintenance or data for post-failure analysis during preventive maintenance or when problems occur.
mdump	Used for copying a memory dump file to a portable medium when a memory dump is collected due to a STOP error.
createdmp	Used for reserving a disc area for a memory dump file when a message is displayed indicating the capacity of the memory dump file is insufficient.
getrasinfo	Used for checking the status of the equipment such as the status of the fan and the temperature inside the chassis.

The Manufacturer provides charged services to analyze the data collected by these maintenance operation commands, such as memory dump files and data for failure analysis.

8.4.1 Log information collection command (logsave)

<Name>

logsave - Collecting log information

<Syntax>

logsave [-e file name][Directory]

<Feature>

The logsave command saves the data used for preventive maintenance and post-failure analysis of problems. The data is compressed and recorded as one file (File name: logsave.zip).

The following options are available for this command. If no options are specified, the logsave directory, is created under the system drive (usually C:¥) and the data is saved under that directory.

-e File name: The data previously saved by the logsave command will be decompressed. For the file name, specify the absolute path of the file you want to decompress. If this option is not used, the logsave command will save the data.

Directory: When the -e option is not used, specify the directory where you want to store the saved data. If this option is not used, a directory, the logsave directory, is created under the system drive (usually C:¥) and the data is saved under that directory.

When the -e option is used, specify the directory where you want to store the decompressed data. If this option is not used, the data is decompressed under the current directory.

Table 8-4 shows the information collected by the logsave command.

Table 8-4 Information Saved by logsave

Item	Description
Windows® event log file	Backup of the event log file
RAS software log data	RAS software operation log
RAS software user setting information	User setting definition file for pop-up notification
Windows® version information	Version information of the Windows® system files and driver files
Minimum memory dump	Files under the directory used for storing a minimum memory dump
System information	System information including hardware resources and software environment.
Output of the RAS information display command	Status of the equipment such as the status of the fan and the temperature inside the chassis and configuration information of the RAS software
Output of the ipconfig command	Network that sets information
RAID log data	RAID operational log

<Diagnosis>

When this command is terminated with an error, the following error message is displayed. If a directory for saving data does not exist, an error message from the Windows® xcopy command is displayed.

Table 8-5 Error Messages of the logsave Command

Error message	Meaning
You do not have the privilege to run this command. Please run this command again on “Administrator: Command Prompt”.	You do not have administrator privileges. Log on to the computer by using an administrator account and run the command again. If User Account Control (UAC) is enabled, start the command prompt with administrator privileges and run the command.

< NOTE >

- When you run the logsave command, log on to the computer by using an administrator account registered on computer (as a member of the Administrators group). You cannot run multiple instances of the logsave command simultaneously.
- Start the command prompt with administrator privileges and run the command.
- The log information can also be collected by using a program in the start menu. For details, refer to “HF-W7500 Model 50 RAS FEATURES MANUAL”.
- Confirm the existence of the collected files by Double-clicking on the saved zip file. If you cannot confirm the collected files, the zip file might be corrupt. Redo logsave command.

8.4.2 Memory dump file copy command (mdump)

<Name>

mdump - Copying a memory dump file

<Syntax>

mdump [-n | -e file name] <Copy (Decompress) destination path name>

<Feature>

The mdump command compresses a memory dump file collected by Microsoft® Windows® when the equipment stops unexpectedly. Then the command copies the compressed memory dump file to a portable medium. The dump file, which is specified in the **Startup and Recovery** window displayed by selecting **Control Panel > System and Security > System > Advanced system settings** and clicking **Settings** under **Startup and Recovery**, and all the files under the minimum dump directory will be saved. The memory dump file is compressed and stored as a file (File name: MEMORY.zip).

As an option, if you use the -e option, the compressed file will be decompressed.

The following options are available for this command:

-n: Files will be copied without compression.

-e file name: A file compressed by the mdump command will be decompressed. You must specify the file name.

Copy destination path name: When the -e option is not specified, specify the drive name of the copy destination. If you want to copy files to a directory, specify a full path including the directory name.

When the -e option is used, specify the directory where you want to store the decompressed files.

- A memory dump file is copied to the copy (decompress) destination specified by this command.
- If a file with the same name as the copy (decompress) destination already exists at the same location, the file is overwritten.
- When you run the mdump command by typing “mdump /?” or “mdump -?” at the command prompt or when there is an error in the specified parameters, a help message will be displayed to show how to use the command.

8. MAINTENANCE OPERATIONS

<Diagnosis>

When this command is terminated with an error, the following error messages is displayed.

Table 8-6 Error Messages of the mdump Command

Message	Description
You do not have the privilege to run this command. Please run this command again on “Administrator: Command Prompt”.	You do not have administrator privileges. Log on to the computer by using an administrator account and run the command again. If User Account Control (UAC) is enabled, start the command prompt with administrator privileges and run the command.

< NOTE >

- When you run the mdump command, log on to the computer by using an administrator account registered on the computer (as a member of the Administrators group). You cannot run multiple instances of the mdump command simultaneously.
- Start the command prompt with administrator privileges and run the command.
- If there is not enough free space on the copy destination, the Compressed Folders Error occurs when you run the mdump command. Make sure that there is a free space that is comparable to the capacity of the physical memory before running the mdump command.
- Do not run the mdump command immediately after the OS start after the blue screen is displayed. If you do, the Compressed Folders Error occurs. For details, refer to “HF-W7500 Model 50 RAS FEATURES MANUAL”.
- Confirm the existence of the memory dump file by Double-clicking on the saved zip file. If you cannot confirm the files, the zip file might be corrupt. Redo mdump command.

8.4.3 Disk area allocation command for saving a memory dump (createdmp)

<Name>

createdmp - Reserving a disk area for a memory dump file

<Syntax>

createdmp

<Feature>

The createdmp command creates a vacant memory dump file beforehand and reserves the disk area for a memory dump in order to prevent the situation where collecting a memory dump fails because the disk capacity is insufficient. By using this command, you can avoid a failure in collecting a memory dump caused by a lack of disk capacity.

The createdmp command reserves a disk area if the following conditions are met. If those conditions are not met, the command terminates with an error. Make sure that the memory dump settings are appropriate and then retry this command. For information about how to set up the memory dump settings, see “8.2.2 Configuring settings related to a memory dump”.

- A “Complete memory dump” is specified to be collected.
- The file name of the memory dump must be correctly input.
- The memory dump file must be able to be overwritten.
- After the area for the memory dump file is allocated, the partition used for allocation still has free space of at least 10 % of the disk capacity:

The size of the disk area to be allocated is as follows.

- The size of the physical memory size plus 10 MB.

< NOTE >

- When you run the createdmp command, log on to the computer by using an administrator account registered on the computer (as a member of the Administrators group). You cannot run multiple instances of the createdmp command simultaneously.
- If User Account Control (UAC) is enabled, start the command prompt with administrator privileges and run the command.

8. MAINTENANCE OPERATIONS

<Diagnosis>

When this command finishes normally, the command exits without output in the command prompt window. When this command is terminated with an error, the following error message is displayed.

Table 8-7 Error Messages of the createdmp Command

Error message	Meaning
Error: In the current settings, memory dump file won't be saved.	A memory dump cannot be collected with the current setting. In the memory dump settings, select a "Complete memory dump" option.
Error: Free disk space is too low.	The free space on the disk is too low. Increase the free space on the disk and retry.
Error: Systemcall failed. (%s, %x) %s: Name of the Windows API function where the error occurred %x: Error code from the Windows API	An internal error has occurred.
You do not have the privilege to run this command. Please run this command again on "Administrator: Command Prompt".	You do not have administrator privileges. Log on to the computer by using an administrator account and run the command again. If User Account Control (UAC) is enabled, start the command prompt with administrator privileges and run the command.

8.4.4 RAS information display command (getrasinfo)

<Name>

getrasinfo - Displays the status of the equipment such as the status of the fan and the temperature inside the chassis as well as the configuration information of the RAS software

<Syntax>

getrasinfo [/status | /setting] [/e file name]

<Feature>

The getrasinfo command displays the status of the equipment such as the status of the fan and the temperature inside the chassis as well as the configuration information of the RAS software at the command prompt. This command can also store the output in the specified file in the text format.

The following options are available for this command. If neither the /status nor the /setting option is used, the command displays both the information about the equipment and the settings of the RAS software.

- /status: Displays the status of the current equipment including the status of the fan and the temperature inside the chassis.
- /setting: The command displays the configuration information of the RAS software.
- /e File name: The output is not displayed at the command prompt but instead stored in the file specified by the file name in the text format.

Table 8-8 shows the information displayed by the getrasinfo command.

Table 8-8 Information Displayed by the getrasinfo Command

Item	Description
Status of the equipment	<ul style="list-style-type: none"> • Fan status • Temperature status • RAID status • Drive status • Memory status
RAS software settings	<ul style="list-style-type: none"> • Automatic shutdown setting • Watchdog timer setting • Self-Monitoring, Analysis and Reporting Technology (SMART) setting • Drive power-on hours monitoring setting • Digital LEDs for Status indication setting • Pop-up display setting

8. MAINTENANCE OPERATIONS

<Display output>

The following is an example of display output when the getrasinfo command is executed without options.

<<getrasinfo result>>		}	Header	
Date: 2017/06/30 17:28:30				
Model Name: HJ-7550				
[Hardware Status]				
[Fan condition]				
PS fan status:	Normal	}	Hardware Status section (Status of the equipment)	
Front fan1 status:	Normal			
Front fan2 status:	Normal			
[Temperature condition]				
Internal temperature status:	Normal			
Internal temperature value:	28 deg C			
[RAID condition]				
Array1				
Status:	Optimal			
RAID level:	1			
[Drive condition]				
Drive bay1				
Type:	HDD			
Status:	Healthy			
Used hours:	2000 hours			
Drive bay2				
Type:	HDD			
Status:	Smart Detected			
Used hours:	5 hours			
[Memory condition]				
DIMM A2 status:	Normal			
DIMM B2 status:	Normal			

Continues on the next page.

[RAS Setting]		} Hardware Status section (Status of the equipment)
[Automatic shutdown setting]		
Fan:	ON	
Temperature:	OFF	
Remote shutdown:	ON	
[Watchdog timer setting]		
Retrigger type:	Automatic	
Timeout:	60 sec	
Interval:	20 sec	
[Drive failure prediction setting]		
Function is available:	Enable	
[Drive used hours monitoring setting]		
Function is available:	Enable	
Drive bay1:	Enable	
Drive bay2:	Enable	
[Advanced]		
Time limit of drive bay1:	20000 hours	
Time limit of drive bay2:	20000 hours	
[Digital LED setting]		
Show Hardware status:	ON	
[Popup setting]		
Function is available:	Disable	
[Advanced]		
Fan:	Enable	
Temperature:	Disable	
SMART:	Disable	
Used hours:	Enable	
RAID:	Enable	
Memory:	Disable	
Memory Failure	Disable	

8. MAINTENANCE OPERATIONS

<Explanation of the display output>

■ Header:

This section shows the date and time when the getrasinfo command is executed and the model name.

The following is the format of the header.

```
<<getrasinfo result>>
Date: YYYY/MM/DD hh:mm:ss
Model Name: HJ-7550
```

YYYY: Year, MM: Month, DD: Day, hh: hour (24-hour clock),
mm: minute, ss: second

■ [Hardware Status] section:

This section shows the status of the equipment. The Hardware Status section has the following subsections.

• [Fan condition] section:

Shows the status of fans. The following table shows the list of items in this subsection and their respective descriptions.

Output item	Description	
<u>xx</u> fan status: <u>yy</u>	xx	Shows the name of the fan. PS: Power fan Front fan1: Front fan1 Front fan2: Front fan2
	yy	Shows the status. Normal: The fan is operating normally. Error: The fan is not operating normally.

• [Temperature condition] section:

Shows the various statuses related to temperature. The following table shows the list of items in this subsection and their respective descriptions.

Output item	Description	
<u>xx</u> Temperature status: <u>yy</u>	xx	Shows the type of temperature Internal: Inside the chassis
	yy	Shows the status. Normal: The temperature is normal. Error: The temperature is not normal.
<u>xx</u> Temperature value: <u>zz</u>	xx	Shows the type of temperature Internal: Inside the chassis
	zz	Shows the temperature value.

- [RAID condition] section :

Shows the RAID status. The following table shows the list of items in this subsection and their respective descriptions.

Output item	Description	
Array <u>xx</u>	xx	Shows the number of the RAID array.
Status: <u>yy</u> (<u>zz</u> <u>ww</u> , <u>Media Error</u>)	yy	Shows the RAID status Optimal : Normal status Degrade : Abnormal status Unknown : Unknown status
	zz	Task in progress in the representation below. Shown only when the task has started. Rebuild : Rebuilding
	ww	Completion rate of task in progress. Shown only when the task has started.
	Media Error	Shown only when a media error is detected during the task.
RAID level: <u>vv</u>	vv	RAID level in the representation below. 1 : RAID1

- [Drive condition] section:

Shows the status of a drive. The following table shows the list of items in this subsection and their respective descriptions.

Display item	Description	
Drive bay <u>xx</u>	xx	Shows the drive bay number.
Type: <u>ww</u>	ww	Show the type of the drive.
Status: <u>yy</u>	yy	Shows the status of the drive. Healthy: Normal Not Connected: No disks are mounted. Smart Detected: SMART is detected. Offline: Offline Rebuild: Rebuilding Overrun: Power-on (=used) hours exceeded the threshold. Unknown: Unknown status Smart Detected, Overrun: SMART is detected and the power-on hours exceeded the threshold.
Used hours: <u>zz</u>	zz	Shows the drive power-on (used) hours.

8. MAINTENANCE OPERATIONS

- [Memory condition] section:

Shows the status of the main memory. The following table shows the list of items in this subsection and their respective descriptions.

Output item	Description	
DIMM <u>xx</u> status: <u>yy</u>	xx	Shows the memory slot name. A2 : DIMM A2 B2 : DIMM B2
	yy	Shows the status of the memory. Normal: Normal Error: Error correction occurs frequently. Not Mounted: A memory module is not mounted.

- [RAS Setting] section:

This section shows the settings of the RAS software. The RAS Setting section has the following subsections.

- [Automatic shutdown setting] section:

Shows the automatic shutdown setting. The following table shows the list of items in this subsection and their respective descriptions.

Output item	Description	
Fan : <u>xx</u>	xx	Shows whether the system is automatically shut down when a fan failure occurs. ON: Automatically shut down. OFF: Not automatically shut down.
Temperature : <u>yy</u>	yy	Shows whether the system is automatically shut down when the temperature is abnormal. ON: Automatically shut down. OFF: Not automatically shut down.
Remote shutdown : <u>zz</u>	zz	Shows whether the system is automatically shut down when the remote shutdown signal is input to the contact. ON: Automatically shut down. OFF: Not automatically shut down.

- [Watchdog timer setting] section:

Shows the watchdog timer setting. The following table shows the list of items in this subsection and their respective descriptions.

Output item	Description	
Retrigger type : <u>xx</u>	xx	Shows the retrigger type. Automatic: Automatically retriggered. Application: Retriggered by an application. Not used: Not used.
Timeout : <u>yy</u>	yy	Shows the timeout when the watchdog timer is automatically retriggered.
Interval : <u>zz</u>	zz	Shows the interval of retriggering when the watchdog timer is automatically retriggered.

- [Drive failure prediction setting] section:

Shows the Self-Monitoring, Analysis and Reporting Technology (SMART) setting.

The following table shows the list of items in this subsection and their respective descriptions.

Output item	Description	
Function is available : <u>xx</u>	xx	Shows whether the Self-Monitoring, Analysis and Reporting Technology (SMART) is enabled or disabled. In the case of the HJ-7550, this setting is fixed to "Enable".

8. MAINTENANCE OPERATIONS

- [Drive used hours monitoring setting] section:

Shows the drive power-on (used) hours monitoring setting. The following table shows the list of items in this subsection and their respective descriptions.

Output item		Description	
Function is available : <u>xx</u>		xx	Shows whether the drive power-on (used) hours monitoring function is enabled or disabled.
Drive bay 1: <u>vv</u>		vv	Shows whether the drive bay 1 power-on (used) hours monitoring function is enabled or disabled.
Drive bay 2: <u>ww</u>		ww	Shows whether the drive bay 2 power-on (used) hours monitoring function is enabled or disabled.
[Advanced]		-	Shows the advanced settings.
	Time limit of drive bay <u>yy</u> : <u>zz</u>	yy	Shows the drive bay number.
		zz	Shows the threshold used for the drive power-on (used) hours monitoring function.

- [Digital LED setting] section:

Shows the setting of the Digital LEDs for Status indication. The following table shows the list of items in this subsection and their respective descriptions.

Output item		Description	
Show Hardware status : <u>xx</u>		xx	Shows whether the hardware status display is enabled or disabled. ON: Enabled OFF: Disabled

- [Popup setting] section:

Shows the pop-up notification setting. The following table shows the list of items in this subsection and their respective descriptions.

Output item	Description	
Function is available : <u>xx</u>	xx	Shows whether the pop-up notification function is enabled or disabled.
[Advanced]	-	Shows the advanced settings.
Fan : <u>yy</u>	yy	Shows whether a pop-up is displayed for a fan failure. Enable: Displayed Disable: Not displayed
Temperature : <u>zz</u>	zz	Shows whether a pop-up is displayed when the temperature is abnormal. Enable: Displayed Disable: Not displayed
SMART : <u>aa</u>	aa	Shows whether a pop-up is displayed when SMART is detected. Enable: Displayed Disable: Not displayed
Used hours : <u>bb</u>	bb	Shows whether a pop-up is displayed when the drive power-on (=used) hours exceeds the threshold. Enable: Displayed Disable: Not displayed
RAID : <u>cc</u>	cc	Shows whether a pop-up is displayed when abnormal RAID status is detected. Enable: Displayed Disable: Not displayed
Memory : <u>dd</u>	dd	Shows whether a pop-up is displayed when frequent memory error correction is detected. Enable: Displayed Disable: Not displayed
Memory Failure : <u>ee</u>	ee	Shows whether a pop-up is displayed when memory failure anticipation is detected. Enable: Displayed Disable: Not displayed

<Diagnosis>

When this command finishes normally, the getrasinfo command returns exit code 0. When this command is terminated with an error, one of the following error messages is displayed and exit code 1 is returned.

Table 8-9 Error Messages of the getrasinfo Command

Error message	Meaning
Usage: getrasinfo [/status /setting] [/e File]	There is an error in the specified options. Specify correct options.
An error occurred in %s. errorcode=%x %s: Function name or internal function name of error Windows API %x: Error code of Windows API or internal function	An internal error has occurred. Re-execute the command.
You do not have the privilege to run this command. Please run this command again on "Administrator: Command Prompt".	You do not have administrator privileges. Log on to the computer by using an administrator account and run the command again. If User Account Control (UAC) is enabled, start the command prompt with administrator privileges and run the command.

< NOTE >

- When you run the getrasinfo command, log on to the computer by using an administrator account registered on the computer (as a member of the Administrators group). You cannot run multiple instances of the getrasinfo command simultaneously.
- Start the command prompt with administrator privileges and run the command.
- When the /e option is used, if a file with the same name as the output file already exists at the same output location, the file is overwritten.
- If the command fails to acquire some of the information required for the output, it is possible that only the section name is displayed in a section or a part of the information is replaced with “---”. If this situation happens, re-execute the command.
- When a drive is newly connected or replaced during maintenance, recognition of the drive may take time in the first startup after it is connected and “Not Connected” may be shown in **Status** of the **Drive condition** section. In that case, reboot the computer.

CHAPTER 9 TROUBLESHOOTING

This chapter explains the possible causes of common problems and the actions to be taken to address those problems. Select an applicable symptom from the list in “9.1 List of Problems”. Follow the link (“9.2 Countermeasures” through “9.6 Digital LED for Status indication”) and take actions according to the instruction. If following the instruction in “9.2 Countermeasures” does not resolve the symptom, contact the system administrator or maintenance personnel.



WARNING

In case of smoke, a burning smell, or the like, unplug the power cord from the outlet, and contact your dealer or maintenance personnel. Using faulty equipment without repair may result in a fire or an electric shock.

9.1 List of Problems

The following is a list of problems that can occur in the equipment. Search for an applicable item in the list below, perform root cause analysis, and take an appropriate action.

9.1.1 Problems that occur before the OS startup

The following is a list of problems that occur before the desktop is displayed (before the OS startup). For information about the names of the lamps on the front panel, see “1.5 Name and Function of Each Part”.

(1) The equipment does not start.

Check the operation of the equipment after the plug of the power cord is connected to the outlet in the order of the following steps 1 through 7. If there is an applicable item, follow the link. (If there are multiple applicable items, the first one has precedence.)

1. When the plug of the power cord is connected to the outlet, the standby lamp is not turned on. (See page 9-3.)
2. When the power switch is turned on, fans rotate and the status lamp is lit, but the status indication LEDs and the Digital LEDs for Status indication do not display anything. (See page 9-3.)
3. The Digital LEDs for Status indication show alphanumeric characters and the system stops. (See page 9-3.)
4. The screen is blank. (See page 9-4.)
5. The screen shows an error message and the system stops. (See page 9-4.)
6. The system stops when the Windows® logo is displayed. (See page 9-5.)
7. The system stops when a blue screen is displayed. (See page 9-5.)

(2) Beep sounds are generated. (See page 9-5.)

(3) The BIOS setup menu cannot be opened. (See page 9-6.)

(4) The remote power on function cannot be activated through the RAS external contact. (See page 9-6.)

(5) WOL cannot be used. (See page 9-6.)

(6) If an extension board is installed, the equipment does not start. (See page 9-6.)

9.1.2 Problems that occur after the OS startup

The following is a list of problems that occur after the desktop is displayed (after the OS startup).

- (1) The alarm lamp is lit and the Digital LEDs for Status indication show alphanumeric characters. Alternately, just the Digital LEDs for Status indication show alphanumeric characters. (See page 9-7.)
- (2) The processing speed of the equipment is slow. (See page 9-9.)
- (3) The equipment does not respond. (See page 9-9.)
- (4) The equipment automatically goes into the standby mode, or restarts. (See page 9-10.)
- (5) The screen flickers or blacks out. (See page 9-11.)
- (6) In the screen resolution setting, an unconnected display is shown. (See page 9-11.)
- (7) Screen display blinks or screen contents are displayed again after blackout in some cases. (See page 9-12.)
- (8) A blue screen is/was displayed. (See page 9-12.)
- (9) The equipment cannot connect to the network. (See page 9-13.)
- (10) The network connection is unstable, or the connection speed is slow. (See page 9-13.)
- (11) A CD or DVD cannot be recognized or cannot be read or written to. (See page 9-14.)
- (12) Writing to a CD or DVD fails. (See page 9-14.)
- (13) A CD or DVD cannot be ejected. (See page 9-15.)
- (14) Keyboard input is not accepted. (See page 9-15.)
- (15) Mouse input is not accepted, or a cursor /button does not work normally. (See page 9-16.)
- (16) A USB device (other than a keyboard and a mouse) cannot be recognized or does not work. (See page 9-16.)
- (17) No sound is generated, or the sound is extremely faint. (See page 9-17.)
- (18) A serial port or a parallel port does not work properly. (See page 9-17.)
- (19) The RAS external contact port does not work properly. (See page 9-18.)
- (20) The equipment cannot be shut down. (See page 9-18.)
- (21) "?" or "!" is displayed by a device manager. (See page 9-19.)

9.2 Countermeasures

9.2.1 Problems that occur before the OS startup

(1) The equipment does not start.

- 1. When the plug of the power cord is connected to the outlet, the standby lamp is not turned on.**

<Possible cause>

Power is not supplied to the equipment.

<Action>

1. Make sure that the plug of the power cord is connected to the outlet.
2. Make sure that the circuit breaker on the power distribution panel is on.
3. If the standby lamp is turned on after steps 1 and 2, turn on the power switch.
-> When the equipment starts, fans rotate and the status lamp is turned on.

- 2. When the power switch is turned on, fans rotate and the status lamp is lit, but the status indication LEDs and the Digital LEDs for Status indication do not display anything.**

<Possible cause>

The equipment has failed.

<Action>

1. Contact your system administrator or maintenance personnel.

- 3. The Digital LEDs for Status indication show alphanumeric characters and the system stops.**

<Possible cause>

An error was detected during POST.

<Action>

1. See "9.6.1 POST messages" and take an appropriate action.
-> When the equipment has recovered, the alphanumeric characters on the Digital LEDs for Status indication disappear, and the OS starts.

4. The screen is blank.

<Possible cause>

The display has a problem.

<Action>

1. Make sure that the power switch of the display is on.
2. Make sure that the plug of the power cord for the display is connected to the outlet.
3. Make sure that the equipment and the display are connected through a display interface cable.
4. Re-examine the display settings. For information about the display settings, refer to the manual of the display.

5. The screen shows an error message and the system stops.

<Possible cause>

The battery is dead, HDDs are not mounted, the OS is corrupted.

<Action>

1. If one of the following error messages is displayed, take a corresponding action.
 - “Error : Remove Battery or Clear CMOS, Load default value”
 - > If this message is displayed each time the equipment starts, the battery is dead.
Contact your system administrator or maintenance personnel.
 - “Operating System not found”
 - > There is an error in an HDD or the OS. Check the following items:
 - i) Check if a USB CD, USB FD, or USB boot device is connected to the equipment.
 - > If a USB CD, USB FD, or USB boot device is connected, disconnect it.
 - ii) Check if an HDD is fully inserted into drive bay 1 and secured by screws.
 - > If the HDD is OK, the HDD is recognized on the BIOS screen.(See “5.6 BIOS Setup”.)
 - iii) If you have a recovery DVD, restore the system drive back to the factory default by using the recovery DVD.

6. The system stops when the Windows® logo is displayed.**<Possible cause>**

There is an error in hardware, or the OS is corrupted.

<Action>

1. Unplug the plug of the power cord from the outlet and remove all USB devices except a keyboard and mouse as well as all extension boards. Then start the equipment. (See “6.3.4 Installing and removing an extension board” about removing an extension board.)
2. If the symptom persists after step 1, the OS may be corrupted. If you have a recovery DVD, restore the system drive back to the factory default using the recovery DVD.

< NOTE >

- Do not connect a USB device during the OS startup because the OS may not start normally.
- When you change screens during the OS startup, the OS does not start normally in some CPU switching devices. If you use a CPU switching device, perform sufficient operation verification.

7. The system stops when a blue screen is displayed.**<Possible cause>**

The equipment has received an active remote shutdown signal.

<Action>

1. Take appropriate action according to “8.3 Startup Suppression on Serious Failure Detection” and “9.3 STOP Error Codes”.

(2) Beep sounds are generated.**a) One beep is generated.****<Possible cause>**

This is just a beep for power-on. This is not an error.

b) Two or more beeps are generated.**<Possible cause>**

A hardware error was detected.

<Action>

1. Check the information displayed on the Digital LEDs for Status indication and take an appropriate action according to “9.6.1 POST messages”.

(3) The BIOS setup menu cannot be opened.

<Possible cause>

Keyboard input is not accepted.

<Action>

1. Disconnect the keyboard cable and securely reconnect it to ensure stable connection.
2. Connect the keyboard cable to another port.

(4) The remote power on feature cannot be activated through the RAS external contact.

<Possible cause>

The remote power on function is not enabled.

<Action>

1. Enable the remote power on function according to “6.5 Enabling the Remote Power On Function”.

(5) WOL cannot be used.

<Possible cause>

The WOL function is not enabled.

<Action>

1. Check which OS is used. If the OS’s specification is not support the WOL function, the WOL function is not available.
2. Enable the WOL function according to “2.7.1 Enabling the WOL (Wake ON LAN) function”.

(6) If an extension board is installed, the equipment does not start.

<Possible cause>

The connection failure of an extension board or an address space conflict with an onboard device is considered.

<Action>

1. Remove the extension board with the power turned off and reinstall it.
2. If the problem cannot be resolved even by performing steps 1, a failure on the extension board is suspected. In that case, take action using the document that comes with the extension board.

9.2.2 Problems that occur after the OS startup

(1) The alarm lamp is lit and the Digital LEDs for Status indication show alphanumeric characters. Alternately, just the Digital LEDs for Status indication show alphanumeric characters.

<Possible cause>

This is a hardware error notification from the RAS software or is displayed by a user application.

<Action>

1. If one of the status indication LEDs is lit in red, this is a hardware error notification from the RAS software. Check the characters displayed on the Digital LEDs for Status indication.
 - When 11, 12 or 13 is displayed on the Digital LEDs for Status indication.
 - > Rotation of a fan is abnormal. (11 indicates a power supply fan failure, 12 indicates a front fan 1 failure, and 13 indicates a front fan 2 failure.)
 - Check the following items.
 - i) Make sure that no foreign objects are attached to the fan.
 - > If any foreign objects are attached, the efficiency of cooling inside the equipment becomes is reduced. Remove the foreign objects.
 - ii) Make sure that the power cord for the fan is connected to a power connector.
 - > A loose connection may have caused the symptom. Remove the power cord for the fan from the power connector and then reconnect them.
 - When 21 is displayed on the Digital LEDs for Status indication.
 - > The temperature is abnormal. Check the following items.
 - i) Make sure that the dust filter at the front of the equipment and the exhaust outlet at the rear are not clogged.
 - > If they are clogged, clean the dust filter and the air intake and exhaust holes.
 - If necessary, replace the dust filter.
 - ii) Make sure that sufficient clearance is provided around the equipment. (See “1.6.2 Installation”.)
 - > If not, provide sufficient clearance around the equipment.
 - iii) Make sure that the temperature of the installation environment (ambient temperature) is less than 40°C.
 - > Remove obstacles to air flow or use air-conditioning to keep the ambient temperature less than 40°C.
 - When 31 or 32 is displayed on the Digital LEDs for Status indication.
 - > Failure is predicted for the drive in drive bay.(31 indicates the drive bay 1, 32 indicates the drive bay 2) We recommend you back up the data and replace the drive.

<Action>

- When 41 or 42 is displayed on the Digital LEDs for Status indication.
-> HDD is abnormal. (41 indicates the drive bay1, 42 indicates the drive bay 2.)
Read the description of “10.4.2 Recovering from HDD failure in one side” and replace an HDD.
- When 4C is displayed on the Digital LEDs for Status indication.
-> RAID status is unknown. (RAS software cannot get RAID status.) Contact your system administrator or maintenance personnel.
- When 4D is displayed on the Digital LEDs for Status indication (*).
-> Media error is occurred on RAID. Read the description of HF-W7500 Model 50 RAS FEATURES MANUAL “2.8.2” and take action accordingly.

(*) This code is not displayed in default setting. Read the description of HF-W7500 Model 50 RAS FEATURES MANUAL “2.8.2” when you want to display this code.

< NOTE >

If one of the status indication LEDs is lit in green, a user application is using the LEDs to display characters. Contact your system administrator or maintenance personnel.

(2) The processing speed of the equipment is slow.**<Possible cause>**

The capacity of the memory or the HDDs are not sufficient.

<Action>

1. Terminate unnecessary applications to increase available memory.
-> When you want to check the usage of the CPU and memory, follow the instructions in “9.5 Checking the System Load by Using Performance Monitor”.
2. Delete unnecessary files to increase free clearance on the HDDs.

(3) The equipment does not respond.**<Possible cause>**

There is an error in hardware or software.

<Action>

1. The screen can seem to be frozen when an application freezes. If the equipment responds by pressing **Alt+Tab** or **Ctrl+Alt+Delete**, try the following procedure.
 - i) Switch applications by pressing **Alt+Tab** and identify which application has frozen.
 - ii) After you identify the frozen application, use Task Manager to terminate the application. To start Task Manager, press **Ctrl+Alt+Delete**. The **Windows Security** window will open. Click **Task Manager**.
 - iii) Restart the equipment.
2. Press the reset switch to collect a memory dump. Then restart the equipment. When you request an analysis of the memory dump (a service provided for a fee), save the log after you restart the equipment (see “8.4 Maintenance Operation Commands”) and contact our sales representatives.
3. If you cannot restart the equipment at step 2, turn off the power of the equipment according to <Forcibly terminating the equipment> below.
4. If executing steps 1 and 2 does not resolve the symptom, remove all USB devices except a keyboard and mouse as well as all extension boards when the power is off and then start the equipment.

<Forcibly terminating the equipment>

If the shutdown fails, press the power switch for at least four seconds. The power is turned off and the equipment goes into the standby mode.

After the equipment goes into the standby mode, turn off the main power switch on the rear of the equipment to shut down the power.

(4) The equipment automatically goes into the standby mode, or restarts.

a) The Digital LEDs for Status indication show alphanumeric characters and the system goes into the standby mode.

<Possible cause>

This is a hardware error notification from the RAS software or is displayed by a user application.

<Action>

1. Check the characters displayed on the Digital LEDs for Status indication.
 - If one of the status indication LEDs is lit in red, this is a hardware error notification from the RAS software. See “9.6.1 POST messages” and take appropriate action.
 - If one of the status indication LEDs is lit in green, a user application is using the LEDs to display characters. Contact your system administrator or maintenance personnel.

b) A warning or error message is recorded in the event log.

<Possible cause>

There is an error in hardware or software.

<Action>

1. Check the description of the messages in the “System” or “Application” category in the event log and take actions accordingly. (See “9.4 Event Log.”)
2. If the source of the message is a component purchased by the user, contact the supplier.

c) Neither a) nor b)

<Possible cause>

There is a problem with a cable connection, or the AC power supply is unstable.

<Action>

1. Make sure that the plug of the power cord is securely connected to the outlet.
2. If the symptom persists after step 1, the AC power supply may be unstable. Confirm that the AC power voltage is appropriate.

(5) The screen flickers or blacks out.**<Possible cause>**

There is an error in the display or in the video board.

<Action>

1. Make sure that the plug of the power cord for the display is connected to the outlet.
2. Make sure that the equipment and the display are connected through a display interface cable. (Check if the connection of the cable is not loose.)
3. Replace the display interface cable with a new one. (Check that the cable is broken.)
4. Re-examine the display settings. For information about how to adjust the display, refer to the manual of the display.
5. When you use a video card, check the following items.
 - i) Make sure that the settings of the video card are correct. (For information about how to set up the video card, refer to the manual of the video card.)
 - ii) Turn off the main power switch. Replace the video card with another one and check whether it works.
6. When you use the display which supports MST (Multi Stream Transport) of the DisplayPort, make sure the following items. (Refer to the manual attached to the display for the setting.)
 - i) If the Display can change the DisplayPort1.1 and the DisplayPort1.2, select the the DisplayPort1.2.
 - ii) If the display can change the setting of MST, set it to "Primary".

< NOTE >

If MST is enabled, the item of "Display Port topology" is displayed when you right-click on the desktop window.

(6) In the screen resolution setting, an unconnected display is shown.**<Possible cause>**

It is possible that an unconnected display is shown due to the specifications of the OS.

<Action>

1. Right-click on the desktop to display a pop-up menu. Click **Screen resolution**.
2. In the screen resolution setting window, select an unconnected display.
3. Under **Multiple Displays**, select **Delete this display**. If this setting change is not applied automatically, click **Apply** to delete the unconnected display.
4. If multiple unconnected displays are shown, repeat steps 2 and 3.

(7) Screen display blinks or screen contents are displayed again after blackout in some cases.

<Possible cause>

Windows® is performing a process to correctly recover the graphics function if the graphics driver takes time in response due to a high load on the system.

<Action>

1. In the case of this phenomenon, when a balloon message “Response stop and recovery of display driver” appears or when a warning log of event ID4101 is recorded in the event log, reduce the system load and use the system with a load that does not cause this kind of indication or recording.

(8) A blue screen is/was displayed.

<Possible cause>

There is an error in the OS or in the equipment.

<Action>

1. If the blue screen is still displayed, record the STOP error code (0x00000080 and so on) or distinguished name (NMI_HARDWARE_FAILURE and so on).
2. If you cannot record the STOP error code, search the “System” category in the event log for the STOP error code.
3. Check the description in “9.3 STOP Error Codes” to determine what caused the memory dump to be collected.
4. When you request an analysis of the memory dump (a service provided for a fee), save the log after you restart the equipment (see “8.4 Maintenance Operation Commands”) and contact our sales representatives.

(9) The equipment cannot connect to the network.**<Possible cause>**

There is an error in the settings of the LAN or the network device (hub and so on), or there is a problem with the cable connection.

<Action>

1. Re-examine the network settings according to the instructions in “2.8 Setting Up the LAN Interface”.
2. Disconnect the LAN cable and securely reconnect it to ensure a stable connection.
3. Make sure that the LAN cable is connected to the correct port.
4. Replace the LAN cable with another LAN cable.
5. When you use network device, check the following items.
 - i) Make sure that the power of the network device is on.
 - ii) Turn on the power of the network device first and then turn on the power of this equipment.
 - iii) Replace the network device with other one to check whether the latter works.

(10) The network connection is unstable, or the connection speed is slow.**<Possible cause>**

There is an error in the settings of the LAN or the network device, or there is a problem with the cable connection.

<Action>

1. Re-examine the network settings according to the instructions in “2.8 Setting Up the LAN Interface”.
2. Disconnect the LAN cable and securely reconnect it to ensure a stable connection.
3. Make sure that the LAN cable is connected to the correct port.
4. Replace the LAN cable with another LAN cable.
5. When you use network equipment, check the following items.
 - i) Turn on the power of the network device first and then turn on the power of this equipment.
 - ii) Replace the network device with other one to check whether the latter works.

(11) A CD or DVD cannot be recognized or cannot be read or written to.

<Possible cause>

An unsupported or bad CD or DVD is used.

<Action>

1. See “5.1 Equipment Specification” and make sure that the CD or DVD you want to use is supported.
2. Check that there are no scratches or dirt on the CD or DVD. If the disc is dirty, clean the disc.
3. Select **Start > Computer** and check if the DVD drive is recognized.
-> If the DVD drive is not recognized, restart the equipment.
4. Use another CD or DVD.

< NOTE >

If you use a USB DVD drive, depending on the DVD drive, it may take around 10 minutes to read a disc (CD or DVD) at the startup of the equipment. If this situation occurs, you may be able to resolve this problem by selecting **disable** for **Legacy USB Support** on the **Advance** tab in the BIOS settings.

(12) Writing to a CD or DVD fails.

<Possible cause>

The capacity of the HDDs are not sufficient, or a bad CD or DVD is used.

<Action>

1. Check that the CD or DVD is writable.
2. If enough free space is not available for the work area on an HDD, clean up files and increase free space on the HDD.
3. Check that there are no scratches or dirt on the CD or DVD. If the disc is dirty, clean the disc.
4. Use another CD or DVD.

(13) A CD or DVD cannot be ejected.**<Possible cause>**

Writing to a disc is ongoing, or there is an error in the DVD drive.

<Action>

1. Check if writing to a disc is ongoing (the drive access lamp is on or flashing). You cannot eject a disc during the write to the disc.
2. Press the eject button a couple of times (at least five times).
3. Insert an eject pin into the manual emergency eject hole. (Refer to “2.6.1 Inserting a CD or DVD”) When the disc tray opens slightly, hold and pull it out by hand.

< NOTE >

- Turn off the main power of the equipment before you eject a disc by using the manual emergency eject hole. Do not insert an eject pin at an angle or apply too much force.
- An eject pin does not come with the equipment. If an eject pin is not available, use instead a pin that fits the hole of the eject hole.

(14) Keyboard input is not accepted.**<Possible cause>**

An application has frozen, there is a problem with the cable connection, or the keyboard has failed.

<Action>

1. Keyboard input may not be accepted temporarily due to a frozen application.

If the equipment responds to **Alt+Tab** or **Ctrl+Alt+Delete**, try the following procedure:

 - i) Switch applications by pressing **Alt+Tab** and identify which application has frozen.
 - ii) After you identify the frozen application, use Task Manager to terminate the application. To start Task Manager, press **Alt+Ctrl+Delete**. The **Windows Security** window will open. Click **Task Manager**.
 - iii) Restart the equipment.
2. Disconnect the keyboard interface cable and securely reconnect it to ensure a stable connection.
3. Connect the keyboard interface cable to another port.
4. Replace the keyboard with another keyboard to check whether the latter works.
5. Reboot the equipment.

(15) Mouse input is not accepted, or a cursor /button does not work normally.

<Possible cause>

The mouse does not work properly due to dust or dirt on the mouse, there is a problem with the cable connection, or the mouse has failed.

<Action>

1. When you use an optical mouse, check the following items.
 - i) Check if dust or dirt is clinging to the optical sensor. If dust or dirt is present, clean it off.
 - ii) Do not use an optical mouse on a glass, mirror, or shiny material. (We recommend using a mouse pad designed for use with an optical mouse.)
2. If you use a mouse that is not an optional component provided by the Manufacturer, refer to the manual of the mouse for information about how to use it.
3. Disconnect the mouse interface cable and securely reconnect it to ensure a stable connection.
4. Replace the mouse with another mouse to check whether the latter works.
5. When you use a USB KVM switch, read the user's manual that comes with the USB KVM switch. The problem may be alleviated if you change settings such as emulation settings.
6. If the OS starts while a serial port is receiving data, use the serial port after the OS starts instead and see whether the problem goes away.

(16) A USB device (other than a keyboard and a mouse) cannot be recognized or does not work.

<Possible cause>

There is a problem with the cable connection, or the device driver for the USB device has not been installed.

<Action>

1. Disconnect the cable for the USB device and securely reconnect it to ensure a stable connection.
2. Replace the cable for the USB device with another cable.
3. If the USB device requires installing a device driver, install the device driver according to the manual of the USB device and restart the equipment.
4. If the USB device requires an external power supply, make sure that the plug of the power cord of the USB device is connected to the outlet.
5. If the USB device uses USB bus power, make sure that the current consumption of the USB device does not exceed the specified maximum current for the USB port of the equipment. (See “5.1 (9) Maximum current specifications”.) If the USB device can accept an external power supply, connect the device to an external power supply.
6. If the above steps 1 through 5 do not resolve the symptom, a failure of the USB device may be the cause. Take action according to the manual of the USB device.

(17) No sound is generated, or the sound is extremely faint.**<Possible cause>**

There is an error in the settings of the equipment and the speakers, there is a problem with the cable connection, or the speakers have failed.

<Action>

1. Adjust the volume of the equipment to an appropriate level. (See <Setting a volume>.)
2. When you use speakers, check the following items.
 - i) Make sure that the speakers have built-in amplifiers.
(If the speakers do not have amplifiers, you cannot hear sound.)
 - ii) Make sure that the plug of the power cord of the speakers is connected to the outlet.
 - iii) Turn on the power of the speakers.
 - iv) Make sure that the volume level of the speakers is adequately adjusted.
 - v) Make sure that the cable from the speakers is connected to LINE OUT.
 - vi) When you record an audio signal from an audio device, connect LINE OUT of the audio device to LINE IN of the equipment by using a cable. (LINE IN cannot be used as a MIC input.)
 - vii) Disconnect the cable from the speakers and securely reconnect it to ensure a stable connection.
 - viii) Use another pair of speakers.

<Setting a volume>

1. Open the Control Panel and click **Hardware and Sound**.
2. Click **Adjust system volume** to adjust the volume.

(18) A Serial port or a parallel port does not work properly.**<Possible cause>**

There is a problem with the cable connection, or the target device has failed.

<Action>

1. Disconnect the cable and securely reconnect it to ensure a stable connection.
2. Check to see if the target device has failed.
3. If the OS starts while a serial port is receiving data, use the serial port after the OS starts instead and see whether the problem goes away.

(19) The RAS external contact port does not work properly.

<Possible cause>

There is a problem with the cable connection or the interface with the target device.

<Action>

1. Disconnect the cable and securely reconnect it to ensure a stable connection.
2. See “5.9.2 External control specifications” and confirm that the external control specifications are met.

(20) The equipment cannot be shut down.

a) The drive access lamp is on or flashing.

<Possible cause>

The shutdown process is simply taking a long time.

<Action>

1. Wait until the shutdown process finishes.

b) other than a)

<Possible cause>

The OS has frozen.

<Action>

1. Press the reset switch to collect a memory dump. Then restart the equipment. When you request an analysis of the memory dump (a service provided for a fee), save the log after you restart the equipment (see “8.4 Maintenance Operation Commands”) and contact our sales representatives.
2. If you cannot restart the equipment at step 1, turn off the power of the equipment according to the instructions in <Forcibly terminating the equipment> below.
3. If executing step 1 does not resolve the problem, remove all USB devices except a keyboard and mouse as well as all extension boards when the power is off and then start the equipment.

<Forcibly terminating the equipment>

If the shutdown fails, press the power switch for at least four seconds. The power is turned off and the product goes into the standby mode. After the equipment goes into the standby mode, turn off the main power switch on the rear of the equipment to shut down the power.

(21) "?" or "!" is displayed by a device manager.

<Possible cause>

Device Driver is not installed.

<Action>

1. When a device is "A", please refer to section 4.8 "Display of Device Manager".
2. When you implement an expansion board, please install a device driver.

9.3 STOP Error Codes

A STOP error code provides a summary of an error cause. STOP error codes are displayed on a blue screen as well as embedded in a memory dump file.

Table 9-1 shows the error cause corresponding to the message which is displayed in the blue screen. In the OS which is later than Windows® 8 and Windows Server® 2012, if there is a Distinguished Name corresponding to a STOP error code, the Distinguished Name is displayed. There are some causes of the STOP error code 0x80, but you can check the detailed information from the event log (Event ID:800, Source:HFWRAS_SYS).

Table 9-1 STOP Error Codes

No.	STOP error code (or Distinguished Name)	Error Cause	Action
1	0x00000080 (NMI_HARDWARE_FAILURE)	—	The error cause is logged in event log. Refer to “Table 9-2 Action list for STOP error code 0x80” and take action. If the error cause was not logged in event log, contact the system administrator or maintenance personnel.
2	0x00009221	The remote shutdown input signal was detected during Windows® startup	For information about the cause of the remote shutdown, ask the system administrator or maintenance personnel.
6	Other than the above	STOP error code for Windows®	For information about a Windows® STOP error, refer to the Microsoft Knowledge Base. When you request an analysis of the memory dump (a service provided for a fee), contact our sales representatives.

Table 9-2 Action list for STOP Error Code 0x80

Contents logged in event log (Event ID:800, Source:HFWRAS_SYS)	Cause	Action
Reset signal was input. Detailed code = 0x9201	Forced recovery from CPU lock	Before a message appears, check whether the reset switch is pressed.
PCI Bus Parity Error was occurred Detailed code = 0x9202.	Hardware NMI	Remove the extension board and replace it with another board and recheck operation. For the replacement work, see “6.4 Installing and Removing Components”.
Uncorrectable Error at DIMM B2. Detailed code = 0x9217	Uncorrectable memory error	Check whether the main memory is mounted correctly. If this error still occurs with the main memory mounted correctly, it may be due to a main memory failure. Contact the system administrator or maintenance personnel.
Uncorrectable Error at DIMM A2. Detailed code = 0x9218		

9.4 Event Log

When a critical event occurs, for example, when the environment information is changed or when a remote shutdown request is generated, this equipment collects logs by using the Windows® event log service.

The following procedure shows how to check the event log.

(The display image assumes Windows® 7 but it is similar other OS.)

1. Open **Control Panel** and click **System and Security > View event logs**.
2. The **Event Viewer** window opens. Select **Windows Logs** and then select **System** or **Application** to check the system log or application log.

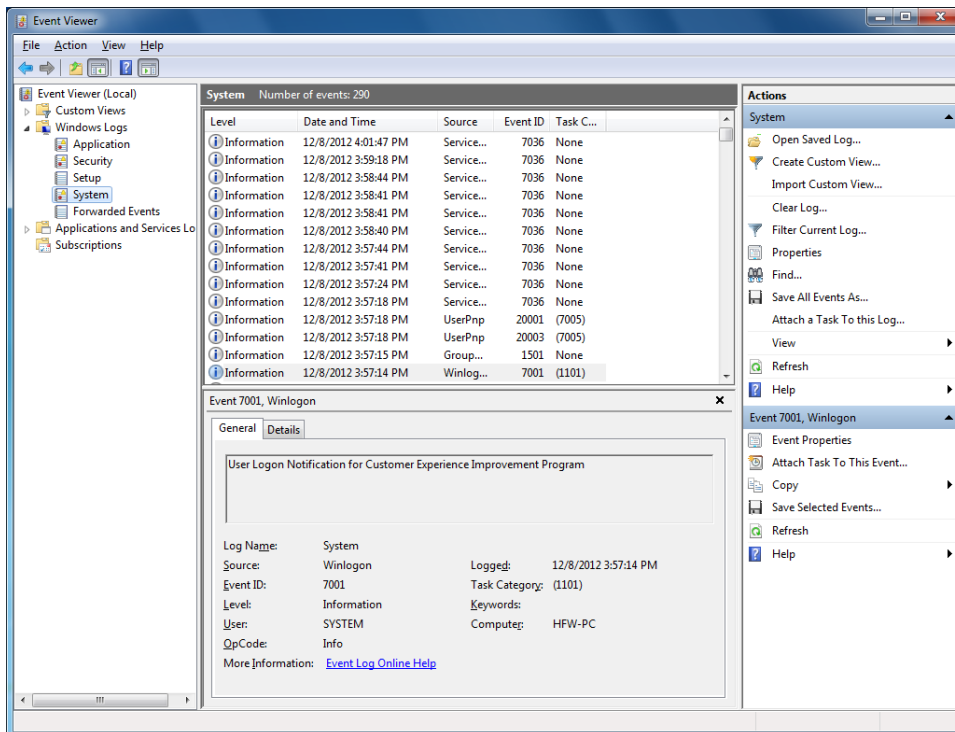

Table 9-3 lists event log entries unique to the equipment. No.1 through 15 and No.18 through 31 are collected in the system log, and Nos.16 and 17 are collected in the application log.

Table 9-3 Event Log Entries Unique to the Equipment (1/3)

No.	Event ID	Source	Type	Description	Action
1	257	HFWRAS_SYS	Error	Revolutions of fan at power supply deteriorated remarkably.	Read the description of fan failure in “9.2.2 (1)” and take an action accordingly.
2	259	HFWRAS_SYS	Warning	The temperature exceeded prescribed value.	Read the description of abnormal temperature in “9.2.2 (1)” and take action accordingly.
3	260	HFWRAS_SYS	Information	Remote shutdown request occurred.	No handling.
4	261	HFWRAS_SYS	Information	Revolutions of fan at power supply returned to normal value.	No handling.
5	263	HFWRAS_SYS	Information	Temperature returned to prescribed value.	No handling.
6	265	HFWRAS_SYS	Warning	A failure may be imminent on the drive of the drive bay%1 (%2).	We recommend you back up the data and replace the drive.
7	268	HFWRAS_SYS	Error	The computer was shut down because temperature became dangerous.	Read the description of abnormal temperature in “9.2.2 (1)” and take action accordingly.
8	270	HFWRAS_SYS	Information	Used hours on the drive of the drive bay%1 exceeded prescribed value.	We recommend you back up the data and replace the drive.
9	279	HFWRAS_SYS	Error	Revolutions of system fan1 deteriorated remarkably.	Read the description of fan failure in “9.2.2 (1)” and take an action accordingly.
10	280	HFWRAS_SYS	Information	Revolutions of system fan1 returned to normal value.	No handling.
11	281	HFWRAS_SYS	Error	Revolutions of system fan2 deteriorated remarkably.	Read the description of fan failure in “9.2.2 (1)” and take an action accordingly.
12	282	HFWRAS_SYS	Information	Revolutions of system fan2 returned to normal value.	No handling.
13	524	HFWRAS_SYS	Information	In the current settings, memory dump file won't be saved. %1	See “8.2.1” and take action, or see “8.2.2” and change the setting by manual operation.

9. TROUBLE SHOOTING

Table 9-3 Event Log Entries Unique to the Equipment (2/3)

No.	Event ID	Source	Type	Description	Action
14	525	HFWRAS_SYS	Information	In the DIMM %1, error correctings have occurred with high frequency.	The DIMM may be out of order. Contact your system administrator or maintenance personnel.
15	539	HFWRAS_SYS	Error	The "%1" was finished.	Hardware monitoring of the RAS software has been terminated. If restarting the equipment does not resolve the error, contact the system administrator or maintenance personnel.
16	540	HFWRAS_SYS	Information	In the DIMM %1, detected the number of single bit error from the OS boot is %2 times(difference between the last time:%3).	No handling.
17	541	HFWRAS_SYS	Warning	DIMM %1 failure might occur.	The DIMM may be out of order. Contact your system administrator or maintenance personnel.
18	769	HFWRAS_APP	Error	An error occurred in %1. errorcode = %2.	An error was generated by the RAS software while the software was running. If restarting the equipment does not resolve the error, contact the system administrator or maintenance personnel.
19	771	HFWRAS_APP	Error	Because a wrong value is set up in registry value "%1", default value %2 is set up.	If restarting the equipment does not resolve the error, contact the system administrator or maintenance personnel.
20	800	HFWRAS_SYS	Information	%1 Detailed code = %2.	A STOP error has occurred. Check the error and contact your system administrator or maintenance personnel.
21	900	HFWRAS_SYS	Information	Power shutdown factor code is %1.	A power shutdown occurred. Contact your system administrator or maintenance personnel.
22	2001	HFWRAS_SYS	Error	The drive on the drive bay%1 is OFFLINE because of failure.	Read the description of abnormal temperature in "10.4.2" and take action accordingly.
23	2002	HFWRAS_SYS	Information	RAID status is OPTIMAL.	No handling
24	2003	HFWRAS_SYS	Error	RAS could not get the RAID status. RAID status is UNKNOWN.	Contact the system administrator or maintenance personnel.

Table 9-3 Event Log Entries Unique to the Equipment (3/3)

No.	Event ID	Source	Type	Description	Action
25	2004	HFWRAS_SYS	Information	RAID status was revealed.	No handling
26	2009	HFWRAS_SYS	Information	The drive on the drive bay% 1 is OFFLINE because of manual operation.	No handling
27	2011	HFWRAS_SYS	Information	Rebuilding was completed. But unreadable sectors were detected on the source drive (Drive bay% 1). (Media error)	Read the description of "10.4.2" and take action accordingly.
28	2012	HFWRAS_SYS	Error	Rebuilding failed due to error on the destination drive (Drive bay% 1).	Read the description of "10.2.2" and build a RAID again.
29	2019	HFWRAS_SYS	Information	Media error is occurred on RAID.	Read the description of HF-W7500 Model 50 RAS FEATURES MANUAL "2.8.2" and take action accordingly.

9. TROUBLE SHOOTING

No.6 : %1 denotes the drive bay number. %2 denotes the manufacturer and the model name of the drive.

No.8 : %1 denotes the drive bay number.

No.13 : %1 denotes the message about a record factor. Any of the following message is recorded.

% 1
Write debugging information setting is not "Complete memory dump"
Overwrite any existing file setting is disable
Paging file size is insufficient
Memory dump file is not exist or Memory dump file size is insufficient

No.14 : %1 denotes the slot number of the DIMM.

No.15 : %1 records one of the following :

FAN, TEMP, RMTSTDN, MEM, CPU, TEMPLOG, WDT, RAID1, RAID SMART, SMART, USETIME, RASLOG, INTERNAL - LOGD

No.16 : %1 denotes the slot number of the DIMM. %2 denotes the cumulative single bit error detection count.

No.17 : %1 denotes the slot number of the DIMM.

No.18 : %1 denotes the function terminated with an error. %2 denotes the error code.

No.19 : %1 denotes the registry key that has an illegal value. %2 denotes the default value of the registry key.

No.20 : %1 and %2 record one of the following combinations :

% 1	% 2
Reset signal was input.	0x9201
PCI Bus Parity Error	0x9202
Uncorrectable Error at DIMM B2.	0x9217
Uncorrectable Error at DIMM A2.	0x9218

No.21 : %1 denotes the power shutdown reason code.

No.22, No.26, No.27, No.28 : %1 denotes the Drive bay No.

9.5 Checking the System Load by Using Performance Monitor

Performance Monitor that comes with Windows® is used for monitoring the usage of the CPU and memory. Use this tool, for example, when you analyze the system load. (The display image assumes Windows® 7 but it is similar other OS.)

The following shows how to start the performance monitor:

1. Click **Start > Control Panel > System and Security > Administrative Tools**.
2. Double-click **Performance Monitor**.
3. The **Performance Monitor** window opens. Click **Performance Monitor** and then click .

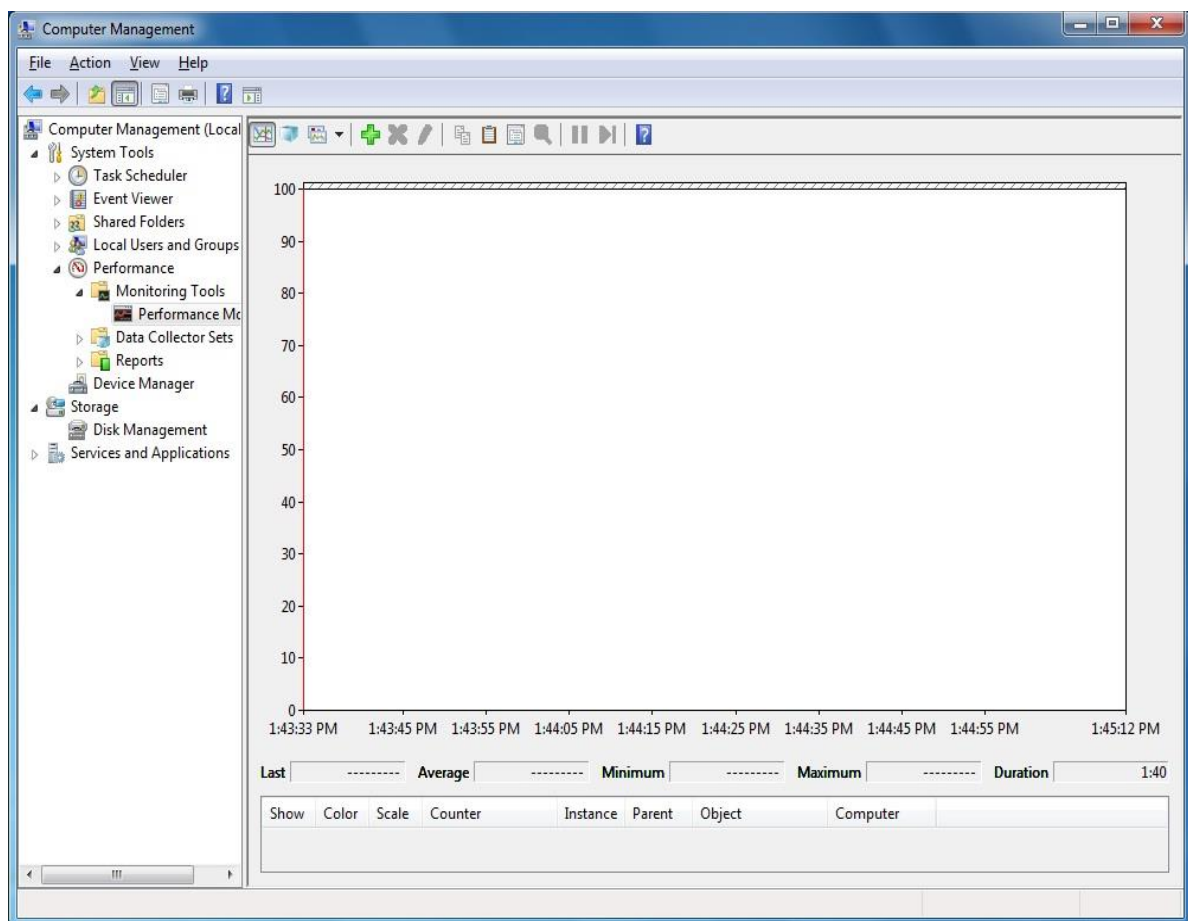

9. TROUBLE SHOOTING

4. The **Add Counters** window opens. If you select items such as Processor, Memory, PhysicalDisk, or Network Interface and click **Add>>**, the performance of those items will be monitored. Click **OK**.

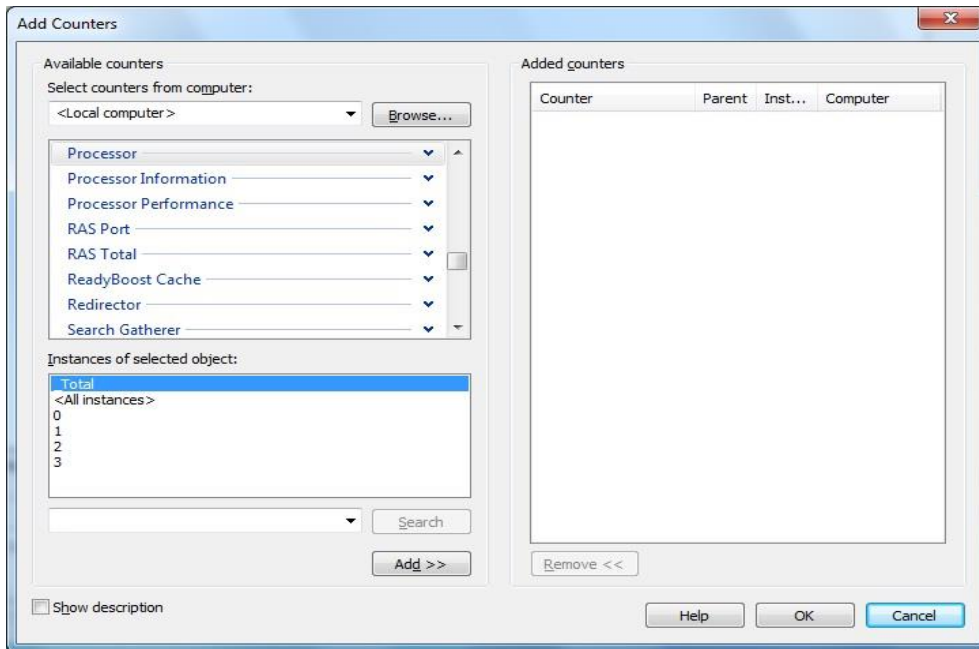

5. In the **Performance Monitor** window, you can check the performance of the items you selected.

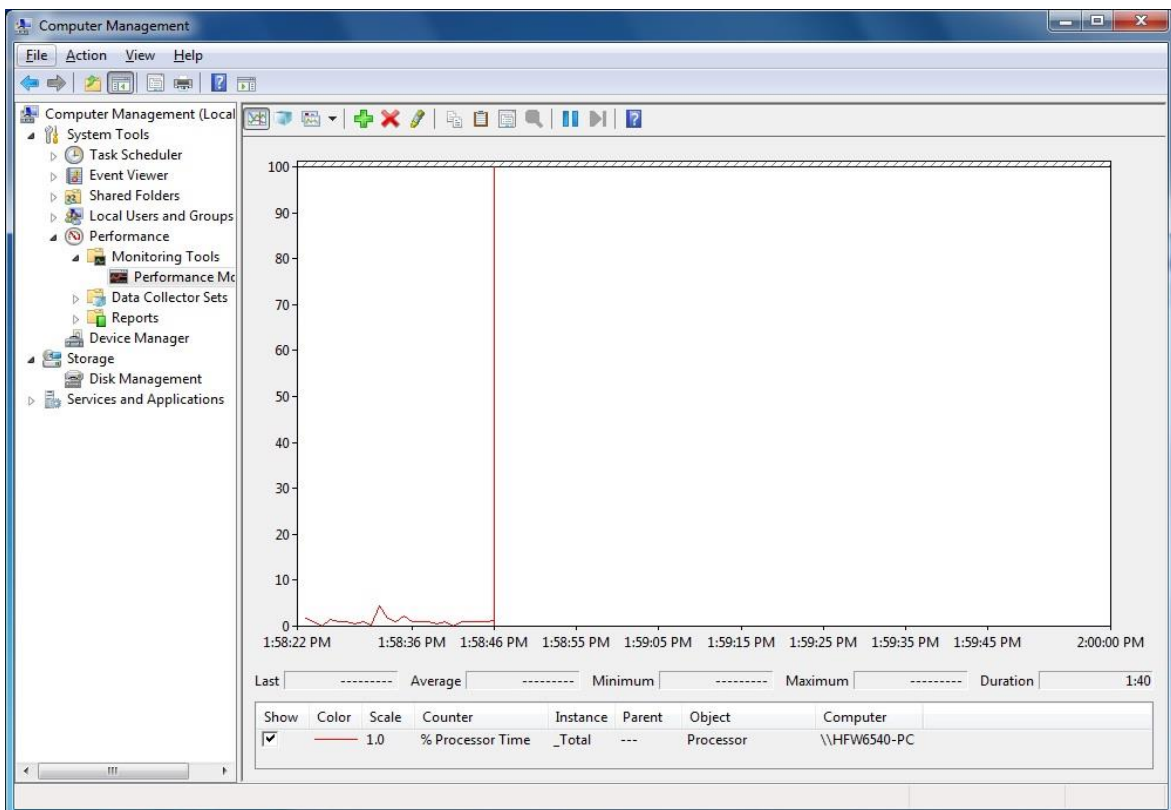

The following table shows a list of performance counters most closely related to the performance of the equipment.

Table 9-4 Performance Counters Related to the Performance of the Equipment

No.	Performance object	Counter	Description
1	Processor	%Processor Time	Shows the CPU usage. If this value is continuously high, the CPU processing power is likely to be a bottleneck.
2	Memory	Pages/sec	Indicates the number of pages per second that are read from or write to the disk in order to resolve page faults. If this value is high, it is likely that the amount of memory is not sufficient. The closer this value is to 0, the better.
3		Available Bytes	Indicates the size of physical memory available for processes. If this value indicates a decreasing trend, it is likely that there is a memory leak.
4		Pool Nonpaged Bytes	Indicates the size of the memory area that will never be paged out to the disk and stays in the physical memory as long as it is allocated. If this value indicates an increasing trend, it is likely that there is a memory leak.
5	PhysicalDisk	%Disk Time	Indicates the percentage of time that the disk is busy reading and writing. If this value is continuously high, the disk performance is likely to be a bottleneck.
6	Network Interface	Bytes Total/sec	Indicates the number of bytes per second that are sent and received by the network adapter. If this value is continuously high compared to the value of No.7, the network is likely to be a bottleneck.
7		CurrentBandwidth	Shows the network bandwidth.

< NOTE >

You may not be able to start collecting performance counter data when the system load is high. After you start collecting performance counter data, confirm that the status of the data collector set you are using is “Running”.

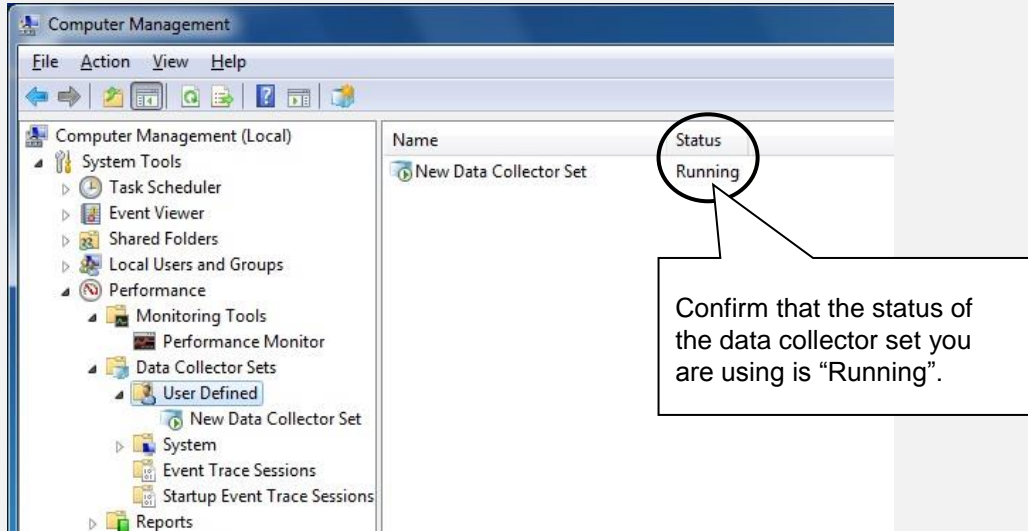

Confirm that the Performance Counter data collection has started properly.

In addition, if the system load is high or if you repeatedly start and stop collecting performance counter data, sometimes you cannot start or stop collecting performance counter data.

If this situation happens, terminate Performance Monitor, wait for a while, restart Performance Monitor, and then start collecting the data.

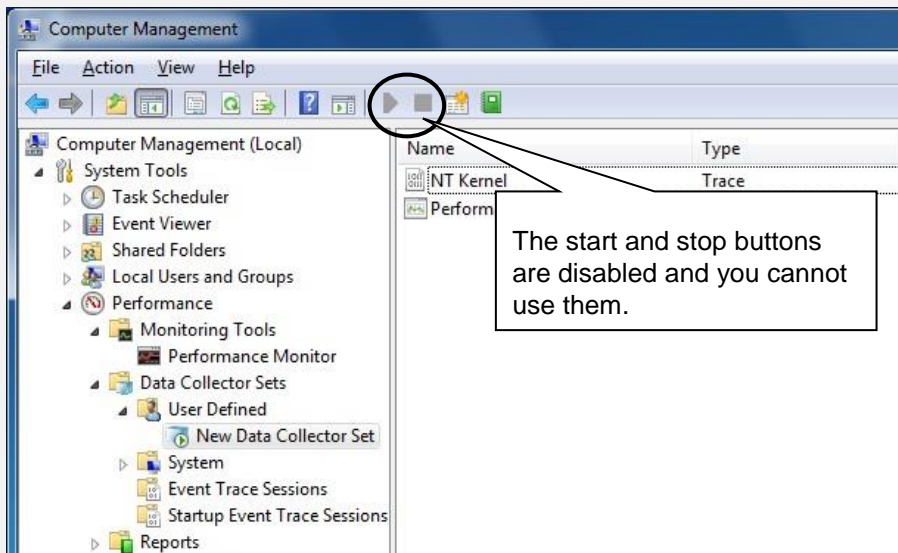

Performance Counter data cannot be collected.

If you cannot start collecting performance counter data even after you have restarted Performance Monitor, restart the system.

9.6 Digital LED for Status indication

The Digital LED for Status indication is used for displaying a POST code at system startup. They are also used for displaying a hardware status code when an error occurs in the hardware during system operation.

The Digital LED for Status indication and the status indication LEDs may remain lit even after the equipment is shut down and put into the standby mode. They remain lit until the main power is shut down or the power is turned on again.

It should be noted that the Digital LED for Status indication may display a code even when there is no error.

(Example : when the BIOS screen is displayed:1F, when the POST code is displayed from turning on the power supply unit to OS boot)

As shown below, the numerical value lamp shows the digits from 0 to F hexadecimally.



9.6.1 POST messages

Power On Self Test (POST) is a function whereby the system BIOS makes routine checks for hardware failure when the power of the computer system is turned on. If any failure is found, the POST code corresponding to the location of the failure is displayed on the Digital LEDs for Status indication situated on the front of the equipment.

When a POST code is displayed, the BIOS status lamp (orange) in the status indication LEDs is lit.

The following table shows the POST codes indicated when the system stops during startup and the respective actions for resolving them.

Table 9-5 POST Codes and Stop Factor/Action (1/2)

POST code	Stop factor/Action	POST code	Stop factor/Action
A3	There may be a problem with the main memory or CPU.	1E	There may be a problem with the main memory.
B5	Check if the main memory is mounted properly.	21	Check if the main memory is mounted properly.
61	There may be a problem with the keyboard or mouse.	57	Check if the main memory is mounted properly.
83	Check if the cables are connected correctly and the keyboard and mouse work properly.	F8	

9. TROUBLE SHOOTING

Table 9-5 POST Codes and Stop Factor/Action (2/2)

POST code	Stop factor/Action	POST code	Stop factor/Action
39 88	The video function is not working properly. When a video board is mounted on an extension slot, make sure the board is mounted properly.	A0 C2	The CPU may not be working properly.
5C 5E 82 F8 F9	There may be a problem with an extension board. Remove the extension board from the slot and mount the board on another slot. Then check if the extension board works.	5C	There may be a problem with the boot device. Check if the HDDs and the DVD drive are mounted properly. If they are mounted properly, the boot device may not be working properly.
93	There may be a problem with a serial device. Check if serial devices are connected correctly and the connected devices work properly.	25 38	There may be a problem with a storage medium (HDD, USB memory, or the like). Check if they are installed properly. If they are mounted properly, the storage medium may be out of order.
34 53 83 84	There may be a problem with a USB device. Check if USB devices are connected correctly and the connected devices work properly.	E0 E1 E2	Rotation of the power supply fan is abnormal. Read the description of fan failure in “9.2.2 (1)” and take action accordingly. Rotation of the CPU fan is abnormal. Read the description of fan failure in “9.2.2 (1)” and take action accordingly. Rotation of the system fan is abnormal. Read the description of fan failure in “9.2.2 (1)” and take action accordingly.

9.6.2 Displaying a hardware status code

A hardware status code is displayed when an error occurs in the hardware during system operation.

When the hardware status code is displayed, the RAS status lamp (red) in the status indication LEDs is lit.

Table 9-6 Hardware Status Code and Cause/Action

Status code	Cause	Action
11	Rotation of the power supply fan is abnormal.	Read the description in "9.2.2 (1)" and take action accordingly.
12	Rotation of the front fan1 is abnormal.	
13	Rotation of the front fan2 is abnormal.	
21	The temperature is abnormal.	Read the description in "9.2.2 (1)" and take action accordingly.
31	Failure is predicted for the drive in drive bay 1.	We recommend you back up the data and replace the drive.
32	Failure is predicted for the drive in drive bay 2.	
41 (*1)	The drive bay1 is abnormal.	Read the description of "10.4.2" and replace an HDD.
42 (*1)	The drive bay2 is abnormal.	
4C	RAID status is unknown (RAS software could not get the RAID status.)	Contact your system administrator or maintenance personnel.
4D (*2)	Media error is occurred on RAID.	Read the description of HF-W7500 Model 50 RAS FEATURES MANUAL "2.8.2" and take action accordingly.

(*1) This code is also displayed during rebuilding.

(*2) This code is not displayed in default setting. Read the description of HF-W7500 Model 50 RAS FEATURES MANUAL "2.8.2" when you want to display this code.

< NOTE >

If a code other than one of the above is displayed, contact the system administrator or maintenance personnel.

This Page Intentionally Left Blank

CHAPTER 10 RAID1

10.1 What is RAID1

This chapter describes how to manage the RAID1 feature.

Note that only HDDs (hard disk drives) are used as a drive for this equipment.

The screen images shown in this chapter are the ones for Windows Server® 2016, but the displayed contents are basically the same for other OS.

NOTICE

- Although this Equipment featuring RAID1 is more reliable than general systems, it is still prone to the loss of data in the HDDs. Not only a machine failure but also an unexpected power failure or an operation error may cause data to be lost for good. To prevent such loss of data, implement scheduled data backup in daily operation. Also, protect the power source from undesirable interruptions by such means as UPS.
- This Equipment is evaluated based on the specific HDD models authorized by the Manufacturer. Replace only with specific HDD models authorized by the Manufacturer. Otherwise, the existing data in the HDD may be lost. Also, always observe the recommended replacement interval for HDDs (Refer to “APPENDIX HANDLING REPLACEABLE COMPONENTS”).
- When HDD1 and HDD2 are installed, their capacities must be the same. Do not install HDDs with different capacity.
- As a replacement HDD, do not use an HDD previously used. If you do, this equipment may not operate properly or the data on the HDDs may be lost because of configuration information mismatches or other reasons.
- Since each Equipment has its own RAID1 configuration information (e.g., serial number), you cannot swap HDDs even between two units of this Equipment. If you dare, the stored data in the newly installed HDD will be erased with automatic RAID1 rebuilding process due to inconsistency of the RAID1 configuration information. If you own multiple units of this Equipment, manage use and inventory of HDDs so that they are not inadvertently mixed.
- Maintenance of a RAID1 system requires a high level of expertise. Should any mistakes be made during the work, the data stored on the HDDs may be lost.

10. RAID1

RAID1 (Redundant Array of Independent Disks Level 1) is a technology generally referred to as "Disk mirroring". The RAID1 is the Disk mirroring by the RAID controller. The RAID1 constructs the system that two HDDs are combined and managed as one RAID1 system (array). Should one HDD fail, you can read correct data from the other HDD. RAID1 uses two HDDs but the capacity available is only equal to the capacity of one HDD.

10.2 Setup

10.2.1 Overview of Setup

The RAID controller of this equipment lets a device recognize two HDDs as one HDD. In addition, the handling of RAID1 reaches only with an RAID controller. Therefore, BIOS, the OS, the device driver to control an RAID controller are unnecessary. Because it is recognized as normal SATA HDD, as for the equipment, the installation of software for RAID controller is unnecessary at the time of setup.

10.2.2 Newly setting up RAID1

NOTICE

- When RAID 1 is newly configured, RAID 1 configuration information corresponding to only one equipment being used is recorded on the HDD. The HDD with configuration information recorded can not be used with other equipment, so users who use multiple equipment, should be careful to handle and store HDDs to not to mix. If HDDs are mixed, the RAID 1 configuration information may be inconsistent, the equipment may not operate normally, or the data in the HDD may be lost.
- When you build a RAID1 system from scratch, prepare two new HDDs selected from the models specified and tested by HITACHI. Otherwise, the data stored on the HDDs may be lost.

To build a new RAID1 system on the Equipment, follow the procedure below.

This procedure is not necessary when you initially use the Equipment because a RAID1 system is factory-set.

1. Prepare two new HDDs.
2. Shut down the OS, disconnect the power cord plug from the outlet, and wait at least one minute. Then, mount new HDDs in drive bay 1 and drive bay 2, referring to Subsection 6.3.6, “Installing and removing an HDD” for details.
3. Turn on the Equipment by connecting the power cord plug to the outlet and pressing the Power switch. The RAID controller automatically detects mounting of the new HDDs and writes the RAID1 configuration information to both of these HDDs.
4. Install the OS using the Recovery DVD. (Refer to “CHAPTER7 RESTORING THE FACTORY-SHIPED CONDITION USING A RECOVERY DVD”.)

10.3 Checking the Status of the RAID1

10.3.1 Checking by the Status Lamps

This equipment has HDD status lamps (an HDD1 status lamp and an HDD2 status lamp) as shown in the figure below. These lamps show the status of each HDD in the RAID1 system.

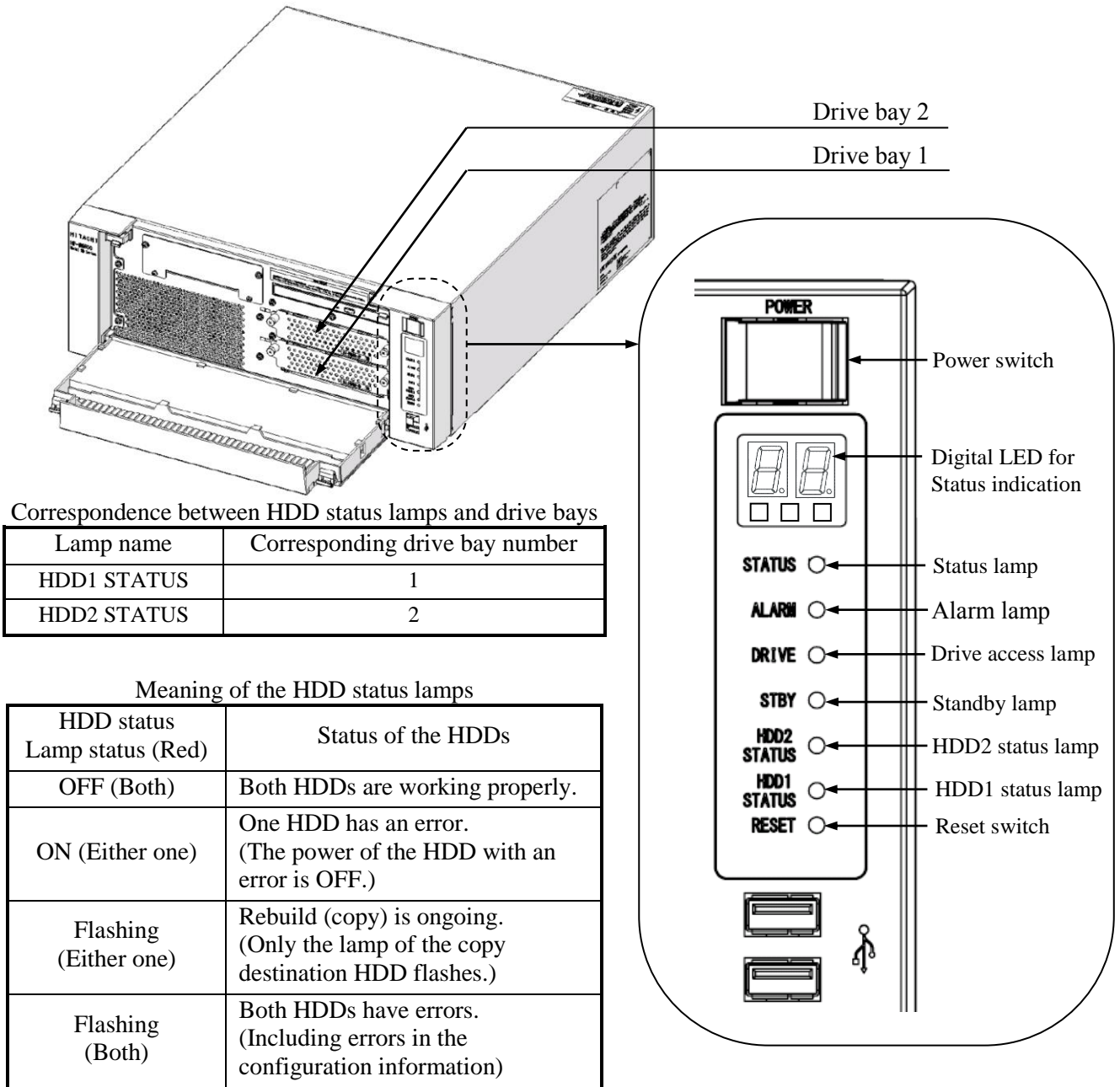

Note : The blinking during rebuilding is about 1 Hz.
 The blinking of both HDDs is abnormal at about 4 Hz.
 Flashing of the HDD status lamp may occur for a moment during operation, but it is not abnormal HDD.

Figure 10-1 HDD status lamp

10.3.2 Checking by the Hardware Status Window

The HDD status of RAID1 can be checked on the hardware status display window of this computer. To open the hardware status display window, double-click the hardware status display icon in the notification area of the task bar.



(Note) This icon is not shown in the notification area of the task bar by default, but it appears by clicking the arrow next to the notification area.

You can also set the icon to be displayed in the notification area of the task bar from below.

1. Click the arrow next to the notification area.
2. Click **Properties** in the displayed menu.
3. Click **Select the icon to be shown on the task bar**.
4. Set **envdisp MFC Application**.

(For Windows®7, make settings to right-click the arrow next to the notification area, click **Customize ...** allows you to make settings to show the icon in the notification area of the task bar.)

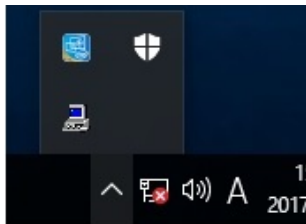

When both HDDs are normal, hardware status is shown as follows.

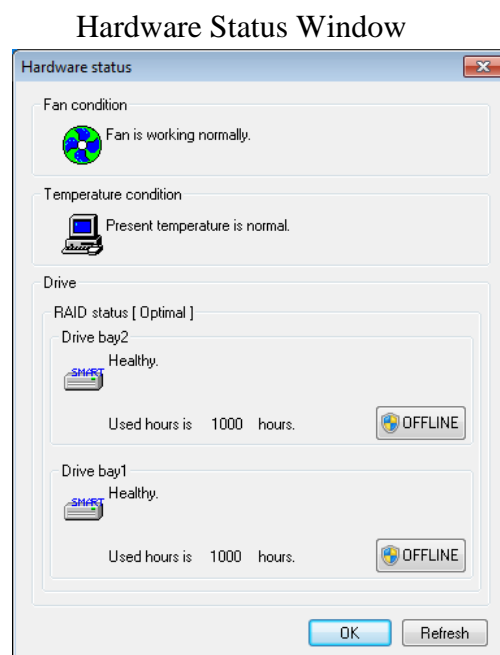

(Note) In the RAS software, HDD and other auxiliary storage devices are generally called “drive”.

10.4 Recovering from failure

10.4.1 Detecting a failure

When failure is detected in the RAID1, the following actions are executed by this equipment.

Table 10-1 Action list of when the RAID detected failure

No.	Action	Cause
1	The HDD status lamp (Red) turns on.	HDD failure (Either one or both HDDs)
2	The Digital LEDs for Status indication indicate an output message. (See "9.6.1 POST messages" and refer to the HF-W7500 Model 50 RAS FEATURES MANUAL.)	
3	The alarm lamp (Red) turns on.	HDD failure (Either drive)
4	MCALL external contact (maintenance personnel call signal) is closed. (See "5.9.2 External control specifications".)	
5	Data is recorded using the event log. (See Section 9.4, "Event Log".)	
6	The HDD status of the RAID1 system is displayed in the Hardware status window. (Refer to the HF-W7500 Model 50 RAS FEATURES MANUAL.)	

The following part of this section describes how to recover from each type of failure and how to handle the situation when a problem occurs during recovery work.

10.4.2 Recovery from a failure in one HDD

NOTICE

- Never remove an HDD when the HDD status lamp of the HDD is OFF. If you do, the data stored in the HDD gets corrupted.
- Wear cotton gloves when replacing an HDD in order to prevent problems caused by static electricity. If you do not, the data stored on the HDD may get corrupted.
- Make sure you check the correct procedure before you start the work. If you do not follow the correct procedure, the data stored on the HDD may be lost.
- As a replacement HDD, do not use an HDD previously used. If you do, this equipment may not operate properly or the data on the HDDs may be lost because of configuration information mismatches or other reasons.
- Mount an HDD securely. Loose contacts and missing screws may result in a failure.
- Do not subject an HDD you are mounting and the already mounted HDDs to shock while replacing an HDD. Otherwise, failure of the equipment may result.
- Until the rebuild is complete, avoid shutting off the power for this equipment or attaching and detaching HDDs. Otherwise, the data on the HDDs may be lost or a failure may result.

To recover from a single-system HDD failure, perform the procedure below.

For recovery from the backup HDD, see “10.5.2 Recovery Using a Backup HDD”.

(1) Replacing an HDD with the equipment turned on

1. Back up data.
(See “(2) Backing Up Files” in “4. HARD DISKS DRIVES (HDDs)” in “PRECAUTIONS”.)
2. Close all running applications.
3. Double-click the hardware status icon shown in the notification area of the task bar to open the hardware status display window. Check defective HDDs on the hardware status display window.

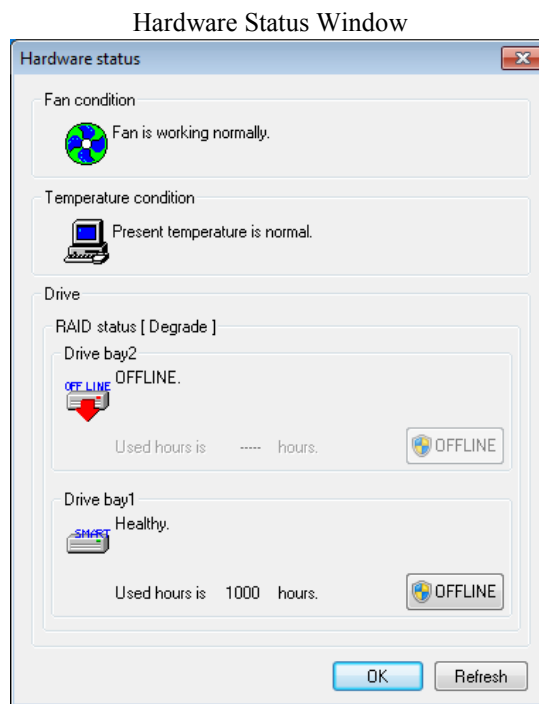

(Note) This window shows that the HDD in drive bay 2 is defective.

4. Remove the defective HDD from the computer.
(See “6.3.6 Installing and removing an HDD”.)

5. On the hardware status window, click the **Refresh** button and confirm that the status of the HDD of the drive bay removed from the computer is shown as “Not mounted”.
- If “Not mounted” is not shown, wait for a while, and then click the **Refresh** button again and confirm that the message “Not mounted” appears.

Hardware Status Window

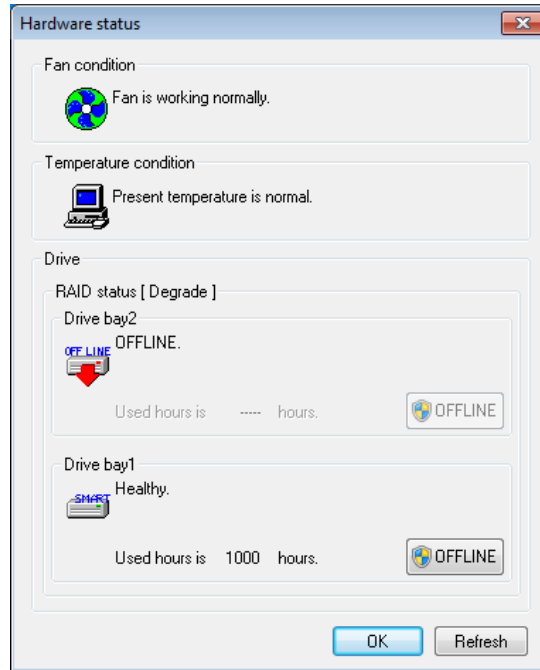

Click **Refresh**

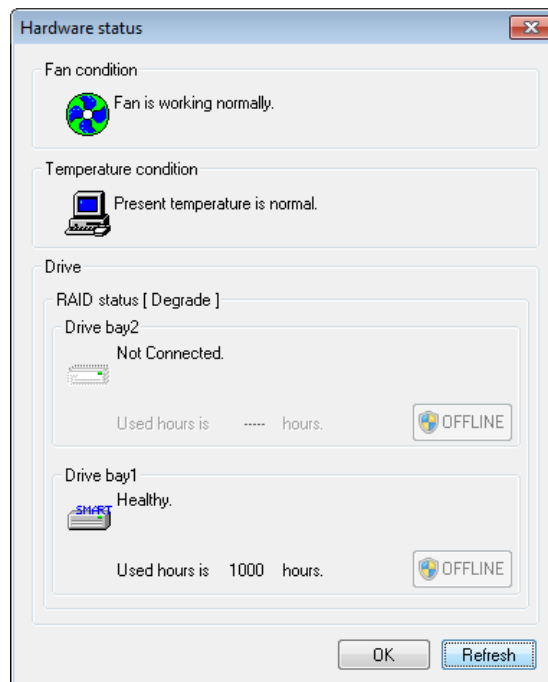

6. Mount the replacement HDD on the computer.

(See “6.3.6 Installing and removing an HDD”.)

The HDD status lamp blinks after a while and RAID1 rebuilding starts.

The RAID1 rebuilding takes about 6 hours. (HDD without load)

<Notice>

- If rebuilding does not start with the HDD status lamp lit after about a minute, remove the HDD and re-execute from the procedure 5.
- After the HDD has been mounted on the equipment, the drive bay status is shown on the hardware status display window until rebuilding is completed. If it is not displayed, click the **Refresh** button.

Hardware status display window (Rebuilding in progress)

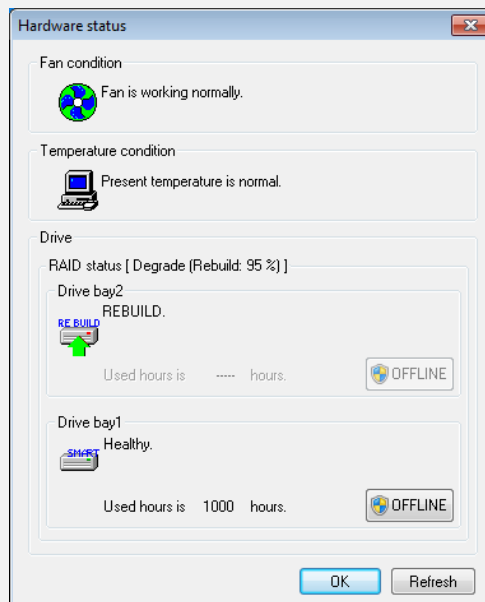

- When rebuilding has been completed, the HDD status lamp turns off and RAID1 is restored. On the hardware status display window, click the **Refresh** button and confirm that the RAID status is shown as [Optimal] and the HDD status of the drive bay where the HDD was replaced is shown as “Healthy”.

Hardware Status Window (Normal)

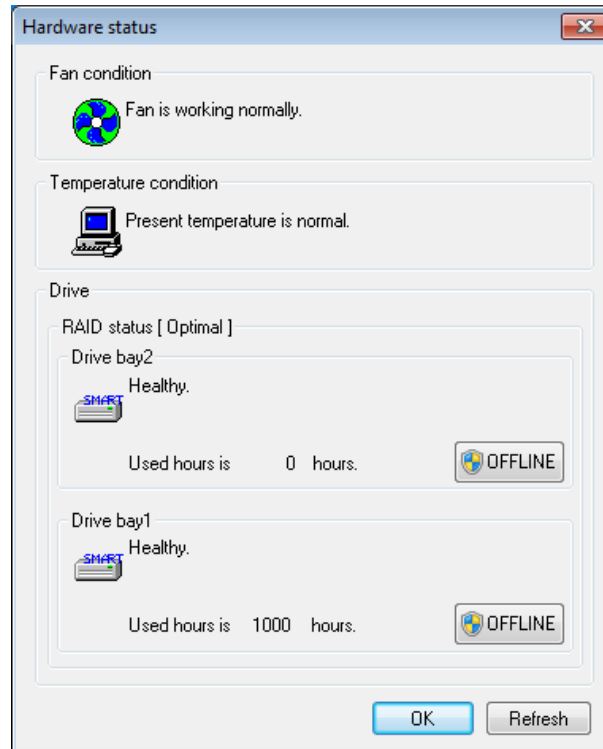

<Notice>

- If the RAID status is shown as [Optimal(Media Error)] after rebuilding has been completed, we recommend that you back up data and then also replace the copy source HDD with a new one. (For the replacement procedure, see “6.3.6 Installing and removing an HDD”.)

After both HDDs have been replaced, set up the equipment again and restore data from the backup file. (For how to set up the equipment again, see “10.2.2 Newly setting up RAID1”.) Or, recover the equipment by using the backup HDD. (See “10.5.2 Recovery Using Backup HDD”.)

Hardware Status Window (Media Error)

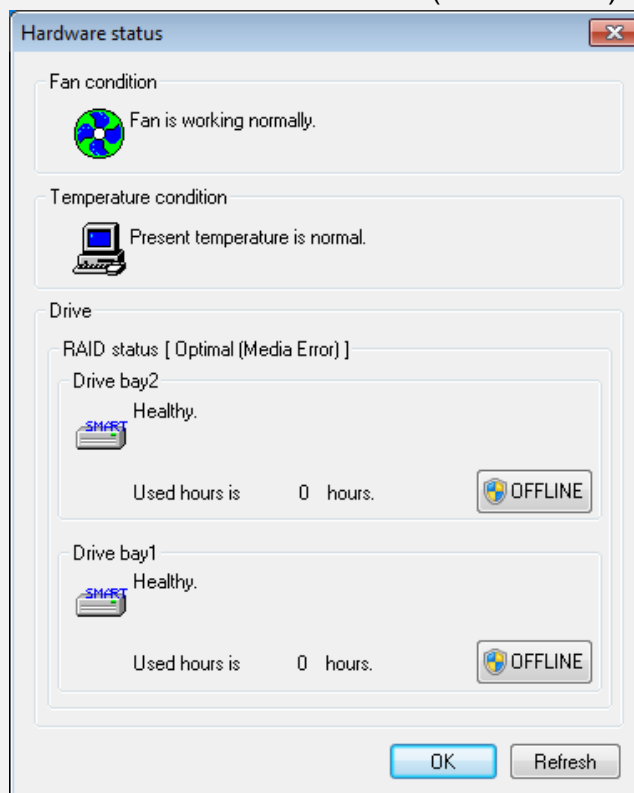

(2) Replacing an HDD with the equipment turned off

1. Back up the data.
(See “(2) Backing Up Files” in “4. HARD DISKS DRIVES (HDDs)” in “PRECAUTIONS”.)
2. Double-click the hardware status display icon displayed in the notification area of the task bar to display the hardware status display window. Check the failed HDD in the hardware status display window.
3. Shut down the OS and unplug the power cord from the outlet. Wait for at least one minute, and then replace the defective HDD with a new one.
(See “6.3.6 Installing and removing an HDD”.)
4. After the equipment is turned on and the OS starts running, mounting of the replacement HDD is automatically detected and rebuilding starts. Confirm that the HDD status lamp of the replaced HDD is blinking.
5. The OS starts while the rebuild process is continuing. The time it takes to rebuild depends on the application being run during the rebuild. Therefore, refrain from running applications until the rebuild is completed.
The rebuild takes about 6 hours. (HDD without load)
If you do not want to start the OS, turn on the equipment and press the **F2** key while the system initialization message is displayed to launch the BIOS setup menu.
6. When the HDD status lamp turns off, the rebuild process is complete. In the Hardware status window, confirm that both HDDs are healthy.
If the BIOS setup menu is started at step 5, open the upper menu "Exit", move the cursor to "Exit Saving Changes", and press Enter.
A message "Save configuration changes and exit now?" is displayed.
Press Enter to restart the equipment.

<Notice>

If the RAID status is shown as [Optimal(Media Error)] after rebuilding has been completed, we recommend that you back up data and then also replace the copy source HDD with a new one. (For the replacement procedure, see “6.3.6 Installing and removing an HDD”.)

After both HDDs have been replaced, set up the computer again and restore data from the backup file. (For how to set up the computer again, see “10.2.2 Newly setting up RAID1”.)

Or, recover the computer by using the backup HDD. (See “10.5.2 Recovery Using Backup HDD”.)

10.4.3 Recovery from Failure in Both HDDs

After you replace both HDDs, set up the equipment again (see "10.2.2 Newly setting up RAID1") and recover the data from the backup file.

Alternatively, recover the equipment using a backup HDD. (See "10.5.2 Recovery Using a Backup HDD".)

10.5 Preventive Maintenance

10.5.1 Creating a Backup HDD

NOTICE

- Wear cotton gloves when replacing an HDD in order to prevent failure caused by static electricity. If you do not, the data stored on the HDD may get corrupted.
- Make sure you check the correct procedure before you start the work. If you do not follow the correct procedure, the data stored on the HDD may be lost.

RAID1 is more reliable compared to a system with a conventional configuration. Nevertheless, the data stored on the HDDs may be lost due to human error or other reasons. If you create a backup HDD, you can recover from such data loss. (Note that you can only restore to the point of backup.) We recommend that you prepare a brand-new HDD or another properly prepared HDD for backup and use it to back up the data periodically. Follow the procedure below, and create a backup HDD.

< NOTICE >

- The following is the procedure for the HDD mounted in drive bay 1. When you make a backup HDD from the HDD mounted to drive bay 2, interpret drive bay 1 as drive bay 2.
- When a replacement HDD is installed, its capacity must be the same as the capacity of the HDD1.

1. Shut down the OS. Unplug the plug of the power cord from the outlet, and wait for at least one minute. Then replace the HDD mounted in drive bay 1 with a replacement HDD. (See "6.3.6 Installing and removing an HDD".)
2. Store the removed HDD in a safety place as a backup HDD.
3. Turn on the power to the equipment. Then the RAID board automatically detects that a brand-new HDD is mounted and starts the rebuild process. Confirm that the HDD1 status lamp is flashing.
4. The OS starts while the rebuild process is continuing. The time it takes to rebuild depends on the application being run during the rebuild. Therefore, refrain from running applications until the rebuild is completed.
If you do not want to start the OS, turn on the equipment and press the F2 key while the system initialization message is displayed to launch the BIOS setup menu.
5. When the HDD1 status lamp turns off, the rebuild process is complete. In the Hardware status window, confirm that both HDDs are healthy. If the BIOS setup menu is started at step 4, open the upper menu "Exit", move the cursor to "Exit Saving Changes", and press Enter. A message "Save configuration changes and exit now?" is displayed. Press Enter to restart the equipment.

10.5.2 Recovery Using a Backup HDD

NOTICE

- Wear cotton gloves when replacing an HDD in order to prevent failure caused by static electricity. If you do not, the data stored on the HDD may get corrupted.
- Make sure you check the correct procedure before you start the work. If you do not follow the correct procedure, the data stored on the HDD may be lost.

Prepare a backup HDD as well as a brand-new HDD, or HDD to which "Initialize Drives" has been applied. Then recover the array by following the procedure below. When you install and remove an HDD, see "6.3.6 Installing and removing an HDD" for the procedure.

< NOTICE >

- The following is the procedure for the HDD mounted in drive bay 1.
When you make a backup HDD from the HDD mounted to drive bay 2, interpret drive bay 1 as drive bay 2.
- When a brand-new HDD or an appropriately prepared HDD is installed, its capacity must be the same as the capacity of the backup HDD.

1. Shut down the OS, and unplug the plug of the power cord from the outlet. If HDDs are mounted, remove both HDDs.
2. Mount a backup HDD in drive bay 1.
3. Turn on the power to the equipment. Confirm that the HDD1 status lamp turns off and the HDD2 status lamp turns on.
4. Mount a brand-new HDD in drive bay 2. The RAID controller automatically detects a brand-new HDD and starts to rebuild the system. Confirm that the HDD2 status lamp is flashing.
5. The OS starts while the rebuild process is continuing. The time it takes to rebuild depends on the application being run during the rebuild. Therefore, refrain from running applications until the rebuild is completed.
If you do not want to start the OS, turn on the equipment and press the F2 key while the system initialization message is displayed to launch the BIOS setup menu.
6. When the HDD2 status lamp turns off, the rebuild process is complete. Also, in the Hardware status window, confirm that both HDDs are healthy.
If the BIOS setup menu is started at step 5, open the upper menu "Exit", move the cursor to "Exit Saving Changes", and press Enter. A message "Save configuration changes and exit now?" is displayed. Press Enter to restart the equipment.

10.5.3 Performing Periodical HDD Replacement

NOTICE

- Wear cotton gloves when replacing an HDD in order to prevent failure caused by static electricity. If you do not, the data stored on the HDD may get corrupted.
- Make sure you check the correct procedure before you start the work. If you do not follow the correct procedure, the data stored on the HDD may be lost.
- As a replacement HDD, do not use an HDD previously used. If you do, this equipment may not operate properly or the data on the HDDs may be lost because of configuration information mismatches, or other reasons.
- Do not replace the two HDDs at the same time. If you do, the data gets corrupted.
- When you replace an HDD, make sure that you set the HDD into the offline mode in the Hardware status window, and then remove that HDD and mount the replacement HDD. If you mount or remove an HDD when the hardware status cannot be checked, for example, immediately after the OS starts, a failure may result.

An HDD is a replacement component that must be replaced periodically. (For information about the recommended replacement cycle, see "APPENDIX HANDLING REPLACEABLE COMPONENTS".)

Follow the procedure below for periodic replacement.

Note: The following is the procedure for replacing the HDD mounted in drive bay 1. When you replace the HDD mounted in drive bay 2, interpret drive bay 1 as drive bay 2 and the HDD1 status lamp as the HDD2 status lamp when following the procedure.

(1) If you replace the HDD while the power to the equipment is turn off

1. Back up the data.
2. Shut down the OS. Unplug the plug of the power cord from the outlet, and wait for at least one minute. Then replace the HDD mounted in drive bay 1 with a replacement HDD. (See "6.3.6 Installing and removing an HDD".)
3. Turn on the power to the equipment. Then the RAID controller automatically detects that the replacement HDD is mounted and starts the rebuild process. Confirm that the HDD1 status lamp is flashing.
4. The OS starts while the rebuild process is continuing. The time it takes to rebuild depends on the application being run during the rebuild. Therefore, refrain from running applications until the rebuild is completed.

If you do not want to start the OS, turn on the equipment and press the F2 key while the system initialization message is displayed to launch the BIOS setup menu.

10. RAID1

5. When the HDD1 status lamp turns off, the rebuild process is complete. Also, in the **Hardware status** window, confirm that both HDDs are healthy.

If the BIOS setup menu is started at step 4, open the upper menu "Exit", move the cursor to "Exit Saving Changes", and press Enter. A message "Save configuration changes and exit now?" is displayed. Press Enter to restart the equipment.

(2) If you replace the HDD while the power to the equipment is turn on

< NOTICE >

You need to have administrator privileges to execute step 3. Log on to the computer using an administrator account and click **OFFLINE**. If "User Account Control" (UAC) is enabled, in a confirmation message, click **Yes**. The **User Account Control** window is displayed. Then click **Continue**.

Note that if "User Account Control" (UAC) is disabled and a user without administrator privileges clicks the **OFFLINE** button, the HDD is not disconnected.

1. Back up the data.
2. Terminate all running applications.
3. Double-click the hardware status icon on the notification area of the taskbar.

The **Hardware status** window appears. In the **Hardware status** window, under **Drive bay1**, click **OFFLINE** to set the HDD into the offline mode.



Hardware status window

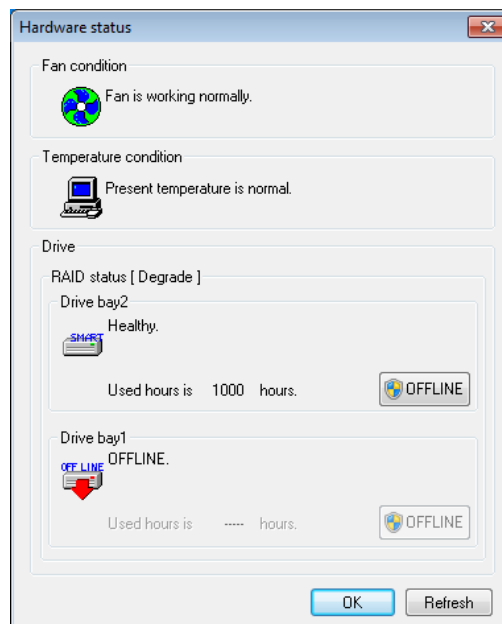

Confirm that the HDD1 status lamp is on. It may take a few tens of seconds for the HDD1 status lamp to turn on.

4. Execute steps 4 to 7 described in "10.4.2 (1) Replacing an HDD with the equipment turned on" and rebuild the array.

This Page Intentionally Left Blank

APPENDIX HANDLING REPLACEABLE COMPONENTS**NOTICE**

Do not use a replaceable component for longer than the recommended replacement cycle. If you do, a deteriorating or worn-out component may cause the equipment to fail.

- As you use a component, it gradually deteriorates and becomes subject to wear and tear. The following components must be replaced at fixed intervals.
- Replacement of these components is not free of charge.
- The recommended replacement cycle in the following table assumes that the average ambient temperature of the system unit is 25°C or less.

Note that when the average ambient temperature exceeds 25°C, the replacement cycle may be shortened in some cases.

Replaceable component	Recommended replacement cycle	Note
HDD	2 years	If the equipment is running 24 hours/7 days a week, the replacement cycle is two years. If the equipment is not running 24 hours/7 days a week, the HDD should be replaced every four years or when the power-on hours count exceeds 20000 hours, whichever comes first. In order to ensure quick recovery of corrupted files, routinely back up your files.
DVD drive	4 years	
Dust filter	1 year	If you do not replace a filter regularly, failure or shorter life span of the equipment may result.
Keyboard (Option)	4 years	
Mouse (Option)	4 years	

< NOTE >

- When you replace a component in order to, for example, repair equipment, you may need to replace the component with a functionally compatible one.
- If you repair a component in a manner not recommended by the Manufacturer, proper operation of the component is not guaranteed.